

Washing Machine

User Manual

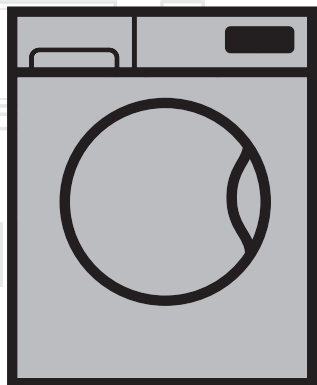

WTV 8734 XCM

EN

Document Number= 2820526303_EN27-10-17(1502)

beko

Dear Customer,

Please read this user manual first!

Thank you for preferring a Beko product. We hope that you get the best results from our product which has been manufactured with high quality and state-of-the-art technology. Therefore, please read this entire user manual and all other accompanying documents carefully before using the product and keep it as a reference for future use. If you handover the product to someone else, give the user manual as well. Follow all warnings and information in the user manual. You can see the user's manual at www.beko.com.

Explanation of symbols



DANGER!

- A hazard with a **high** level of risk which, if not avoided, will result in death or serious injury.
-
-



WARNING!

- A hazard with a **medium** level of risk which, if not avoided, will result in death or serious injury.
-
-



CAUTION!

- A hazard with a **low** level of risk which, if not avoided, will result in small or medium injury.
-
-



NOTE

Useful information or hints about usage.



This product was manufactured using the latest technology in environmentally friendly conditions.

CONTENTS

1.General safety instructions	5
1.1 Children's safety	5
1.2 Product safety	6
1.3 Electrical safety.....	6
1.4 Hot surface safety	7
1.5 Other	7
2.Instructions for environmental protection	8
2.1 Compliance with WEEE Directive	8
2.2 Disposing of the waste product.....	8
2.3 Package information.....	8
2.4 What you can do for energy saving	9
3 Intended use	10
4.Your product	11
4.1 Overview.....	11
4.2 Package contents.....	12
4.3 Control panel	13
4.4 Screenshot	14
5.Technical specifications	15
6. Installation	16
6.1 Appropriate installation location	16
6.2 Removing packaging reinforcement.....	17
6.3 Removing transportation safety bolts.....	18
6.4 Connecting water supply.....	19
6.5 Connecting the water draining hose to the drain	20
6.6 Adjusting the feet.....	21
6.7 Electrical connection.....	22
7. Initial use	23
7.1 Drum cleaning.....	23
8. Preparing to wash	24
8.1 Sorting the laundry	24
8.2 Preparing laundry for washing.....	25
8.3 Loading and removing the laundry.....	25
8.4 Using detergent.....	26
8.4.1 Detergent drawer	26
8.4.2 Detergent, softener and other cleaning agents	26
8.4.3 Choosing the detergent.....	27
8.4.4 Adjusting detergent amount.....	27
8.4.5 Using liquid or gel detergent	27
8.4.6 Using tablet and capsule liquid detergents.....	28
8.4.7 Using softeners.....	28

8.4.8 Using starch.....	28
8.4.9 Using limescale remover	28
8.4.10 Using bleaches.....	28
9. Programmes and auxiliary functions	29
9.1 Programme selection.....	29
9.2 Programmes	30
9.3 Programme table.....	35
9.4 Auxiliary function selection.....	37
9.4.1 Auxiliary functions	38
9.4.2 "Functions/Programmes Selected by Pressing the Function Buttons for 3 Seconds"	38
10. Programme setting	40
10.1 Temperature selection	40
10.2 Spin speed selection.....	40
10.3 Quick Wash Setting (Express).....	41
10.4 Starting the programme	42
10.5 Programme steps.....	42
10.6 End of programme.....	43
11. Programme options	44
11.1 Setting the end time.....	44
11.1.1 Cancelling the end time setting.....	45
11.2 Switching the machine to standby mode and adding laundry.....	45
11.3 Cancelling the programme.....	46
12. Additional features	47
12.1 Activating and deactivating the audio warning	47
12.2 Loading door lock	47
12.2.1 Opening the loading door in case of power failure:.....	48
12.3 Drum Illumination.....	48
13. Maintenance and cleaning	49
13.1 Cleaning the detergent drawer	49
13.2 Cleaning the loading door	49
13.3 Cleaning the body and control panel	49
13.4 Cleaning the water intake filters.....	50
13.5 Cleaning the pump filter	50
13.5.1 Cleaning dirty filters.....	51
14. Troubleshooting	52

1. General safety instructions

1.1 Children's safety



WARNING!

- Children under the age of **3** should be kept away unless continuously supervised.
- This product can be used by children at and above **8** years old and by persons whose physical, sensory or mental capabilities were not fully developed or who lack experience and knowledge provided that they are supervised or trained on the safe usage of the product and the risks it brings out.
- Children under the age of 8 should be prevented from accessing and tinkering with the product.
- Cleaning and user maintenance works should not be performed by children unless they are supervised by someone.
- Electrical products are dangerous for the children.
- Use child lock to prevent children from intervening with the product.
- Do not forget to close the loading door when leaving the room where the product is located.
- Packaging materials are dangerous to children.

1.2 Product safety



WARNING!

- Unplug the product when not in use.
- Always have the installation and repairing procedures carried out by the Authorised Service Agent.
- Do not force open the locked loading door. The door will open immediately after the washing cycle has ended. If the door does not open, apply the solutions provided for "Loading door cannot be opened." error in the Troubleshooting section. In case of forcing the loading door to open, the door and the lock mechanism may get damaged.
- Never open the loading door or remove the filter while there is still water in the drum. Otherwise, risk of flooding and injury from hot water will occur.
- The water supply and draining hoses must be securely fastened and remain undamaged.

1.3 Electrical safety



DANGER!

- Do not operate faulty products until repaired by an Authorised Service Agent.
- Do not try to reach interior parts of the product other than the parts stated in maintenance instructions.
- Never wash the product by spreading or pouring water onto it!
- Never touch the power cable plug with wet hands!

1.4 Hot surface safety



WARNING!

- The glass of the loading door gets too hot while washing at high temperatures. Therefore, especially do not allow children touch the glass while washing.



1.5 Other



- Do not use combustible, flammable and other similar chemicals for product cleaning or other purposes.
- Do not step or stand on the product.
- Do not place heavy objects on the product.
- If you will place a dryer on to the washing machine, secure it with the suitable connection apparatus that you can obtain from the Authorised Service Agent.
- Unplug the product, turn the tap off and contact your Authorised Service Agent without tampering with the product if the product has been damaged.
- Keep your pets away from the washing machine.

2. Instructions for environmental protection

2.1 Compliance with WEEE Directive

This product does not contain harmful and forbidden materials described in the "Regulation on the Control of the Waste Electrical and Electronic Equipment" issued by T.R. Ministry of Environment and Urbanization. It complies with the WEEE Directive.

2.2 Disposing of the waste product



This product has been manufactured with high quality parts and materials which can be reused and are suitable for recycling. Therefore, do not dispose the product with normal domestic waste at the end of its service life.

Take it to a collection point for the recycling of electrical and electronic equipment. Please consult your local authorities to learn the nearest collection point. Help protect the environment and natural resources by recycling used products.

For children's safety, cut the power cable and break the locking mechanism of the loading door so that it will be non-functional before disposing of the product.

Compliance with RoHS Directive:

The product you have purchased complies with EU RoHS Directive (2011/65/EU). It does not contain harmful and prohibited materials specified in the Directive.

2.3 Package information

Packaging materials of the product are manufactured from recyclable materials in accordance with our National Environment Regulations. Do not dispose of the packaging materials together with the domestic or other wastes. Take them to the packaging material collection points designated by the local authorities.

2.4 What you can do for energy saving



CAUTION!

- Comply with the information in the programme and consumption table section.
 - If the washing machine is overloaded, its washing performance will drop.
 - Moreover, noise and vibration problems may occur.

Following information will help you use the product in an ecological and energy-efficient manner.

- a) Operate the product in the highest load capacity allowed for the programme you have selected, but do not overload. See, "Programme and consumption table".
- b) Follow the recommended temperatures in the programme and consumption table.
- c) Wash slightly soiled laundry at low temperatures.
- d) Select faster programmes for small quantities of lightly soiled laundry.
- e) Do not use prewash and high temperatures for laundry that is not heavily soiled or stained.
- f) If you plan to dry your laundry in a dryer, select the highest spin speed recommended during washing process.
- g) Do not use detergent in excess of the amount recommended on the detergent package.

3 Intended use

- a) This product has been designed for domestic use.
- b) It is not suitable for commercial use and it must not be used for anything other than its intended use.
- c) Suitable for textile washable in washing machines.
- d) The manufacturer waives any responsibility arisen from incorrect usage or transportation.
- e) The service life of your product is 10 years. During this period, original spare parts will be available to operate the product properly.
- f) Do not wash the items such as carpets, rugs and etc. in the machine. Permanent damage occurs in the machine.

4. Your product

4.1 Overview

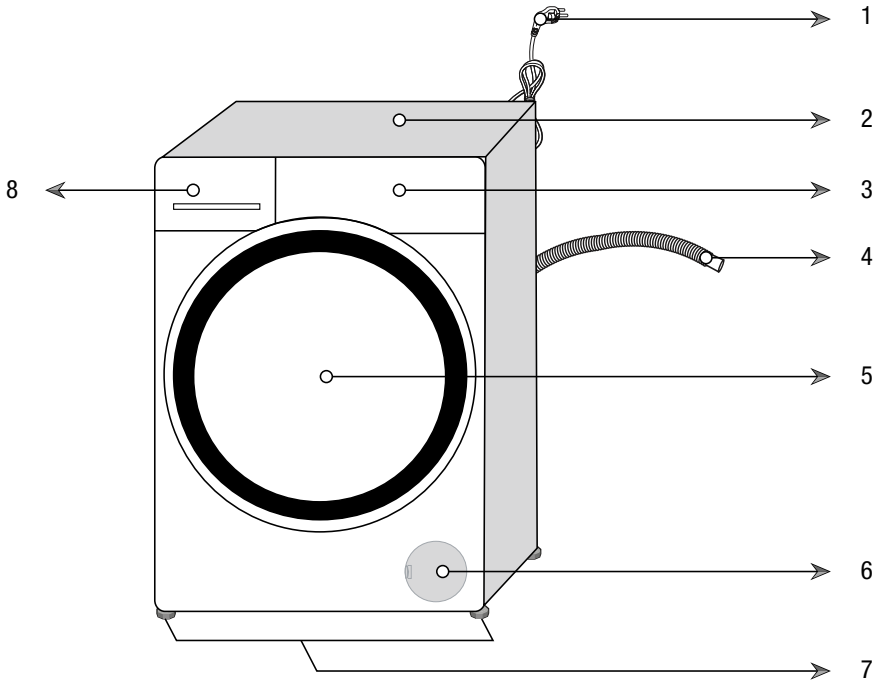

- 1- Power cable
- 2- Top panel
- 3- Control panel
- 4- Water discharge hose
- 5- Loading door
- 6- Filter cap
- 7- Adjustable feet
- 8- Detergent drawer

4.2 Package contents



Power cable



Water discharge hose

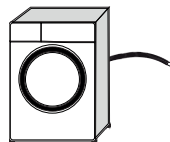

Transportation safety bolts

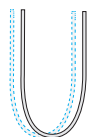

Mains water inlet hose

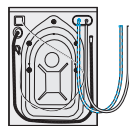

Liquid detergent container



User manual



Plastic plug group



NOTE

- Figures in this manual are schematic and may not match the product exactly.

4.3 Control panel

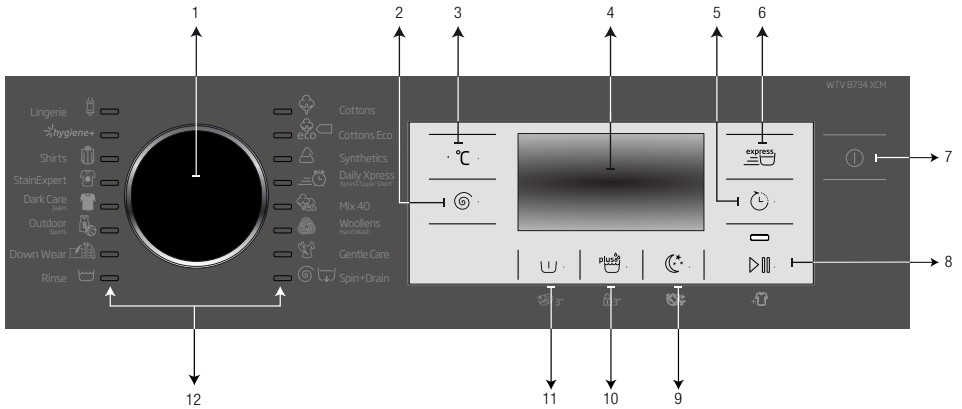

- 1 - Programme selection knob
- 2 - Spin level adjustment button
- 3 - Temperature level adjustment button
- 4 - Display
- 5 - End Time adjustment button
- 6 - Quick Wash setting button
- 7 - On / Off button
- 8 - Start / Pause button
- 9 - Auxiliary function button 3
- 10 - Auxiliary function button 2
- 11 - Auxiliary function button 1
- 12 - Programme selection lights

4.4 Screenshot

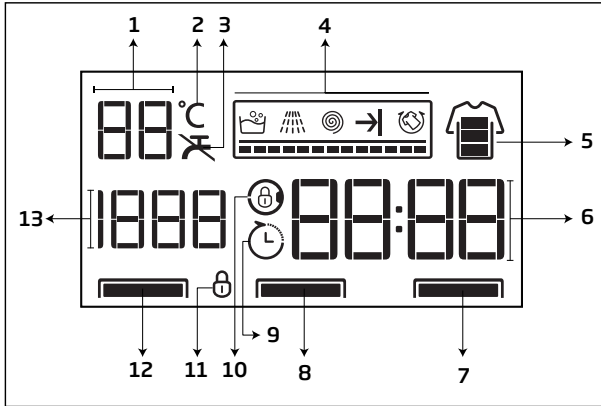

- 1 - Temperature indicator
- 2 - Temperature symbol
- 3 - No water symbol
- 4 - Programme follow-up indicator
- 5 - Quick wash indicator
- 6 - Duration information
- 7 - Auxiliary functions light 1
- 8 - Auxiliary functions light 2
- 9 - Delayed start enabled symbol
- 10 - Door lock is engaged symbol
- 11 - Child lock enabled symbol
- 12 - Auxiliary functions light 3
- 13 - Spin speed selection indicator

5. Technical specifications

Complying Commission Delegated Regulation (EU) No 1061/2010

Supplier name or trademark	Beko
Model name	WTV 8734 XCM
Rated capacity (kg)	8
Energy efficiency class / Scale from A+++ (Highest Efficiency) to D (Lowest Efficiency)	A+++
Annual Energy Consumption (kWh) ⁽¹⁾	175
Energy consumption of the standard 60°C cotton programme at full load (kWh)	0,915
Energy consumption of the standard 60°C cotton programme at partial load (kWh)	0,710
Energy consumption of the standard 40°C cotton programme at partial load (kWh)	0,630
Power consumption in 'off-mode' (W)	0,500
Power consumption in 'left-on mode' (W)	0,700
Annual Water Consumption (l) ⁽²⁾	9239
Spin-drying efficiency class / Scale from A (Highest Efficiency) to G (Lowest Efficiency)	B
Maximum spin speed (rpm)	1400
Remaining moisture Content (%)	53
Standard cotton programme ⁽³⁾	Cotton Eco 60°C and 40°C
Programme time of the standard 60°C cotton programme at full load (min)	260
Programme time of the standard 60°C cotton programme at partial load (min)	235
Programme time of the standard 40°C cotton programme at partial load (min)	230
Duration of the left-on mode (min)	N/A
Airborne acoustical noise emissions washing/spinning (dB)	51/74
Built-in	No
Height (cm)	84
Width (cm)	60
Depth (cm)	59
Net weight (±4 kg.)	70
Single Water inlet / Double Water inlet	• / -
• Available	
Electrical input (V/Hz)	230 V / 50Hz
Total current (A)	10
Total power (W)	2200
Main model code	9811

⁽¹⁾ Energy Consumption based on 220 standard washing cycles for cotton programmes at 60°C and 40°C at full and partial load, and the consumption of the low-power modes. Actual energy consumption will depend on how the appliance is used.

⁽²⁾ Water consumption based on 220 standard washing cycles for cotton programmes at 60°C and 40°C at full and partial load. Actual water consumption will depend on how the appliance is used.

⁽³⁾ "Standard 60°C cotton programme" and the "standard 40°C cotton programme" are the standard washing programmes to which the information in the label and the fiche relates and these programmes are suitable to clean normally soiled cotton laundry and that they are the most efficient programmes in terms of combined energy and water consumption.

Technical specifications may be changed without prior notice to improve the quality of the product.

6. Installation

6.1 Appropriate installation location



WARNING!

- Damaged products cause risks for your safety.
 - Prior to installation, visually check if the product has any defects on it.
 - If so, do not have it installed.



CAUTION!

- Do not place the product on a floor without sufficient capacity to carry the load.
 - Otherwise, the product or the floor may be damaged.
 - Total weight of the washing machine and the dryer -with full load- when they are placed on top of each other is approx. 180 kilograms.
- Do not install the product in places where there is the risk of freezing.
 - Otherwise, your product will be damaged and your house will be under risk of flood.



NOTE

- Preparation of the location and electrical, tap water and waste water installations at the place of installation is under customer's responsibility. Refer to the nearest Authorised Service Agent for installation of the product after those preparations are complete.
- Make sure that the water inlet and drain hoses as well as the power cable are not folded, pinched or crushed while pushing the product into its place after installation or cleaning procedures.
- Manufacturer shall not be held liable for damages that may arise from procedures carried out by unauthorised persons.

- a) Place the product on a rigid, flat and level surface.
- b) Never place the product on a carpet-covered floor.
- c) Leaving a gap at the sides of the machine is suggested to reduce vibration and noise
- d) Do not place the product on any platform.
- e) Do not place heat sources such as Hobs, Irons, Ovens, etc. on the washing machine and do not use them on the product.

6.2 Removing packaging reinforcement



CAUTION!

- Seek someone's help for this procedure.
 - Risk of getting injured.



To remove the packaging reinforcement;

- a) Tilt the product backwards.
- b) Remove the packaging reinforcement by pulling the ribbon.

6.3 Removing transportation safety bolts



CAUTION!

- Remove the transportation safety bolts before operating the product!
 - Otherwise, the product will be damaged.

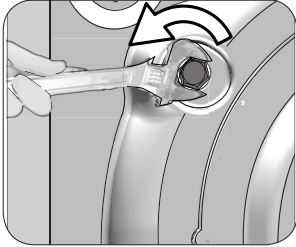

- a) Loosen all transportation safety bolts with an appropriate wrench until they turn freely.

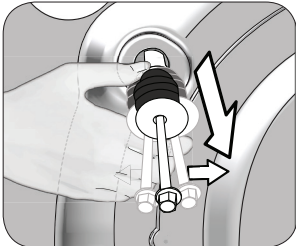

- b) Remove transportation safety bolts by turning them gently.

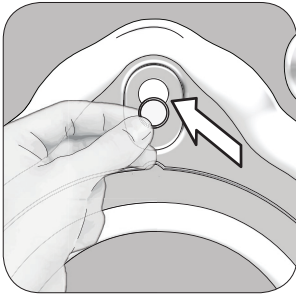

- c) After removing bolts, close the holes with plugs provided in the user manual bag.



NOTE

- Keep the transportation safety bolts in a safe place for reuse when the product needs to be moved again in the future.
- Before moving the product, install the transportation safety bolts in reverse order of the disassembly procedure.

6.4 Connecting water supply



CAUTION!

- The water supply pressure required to run the product is between 1 to 10 bars (0.1 – 1 MPa). (It is necessary to have 10 – 80 litres of water flowing from the fully open tap per minute.)
 - Attach a pressure reducing valve if water pressure is higher.
- Do not use old or used water inlet hoses on the new product.
 - It may cause stains on your laundry.
- Do not plug the product's cold water inlet to hot water outlet.
 - Your laundry may get damaged or the product will switch to protection mode and will not operate.

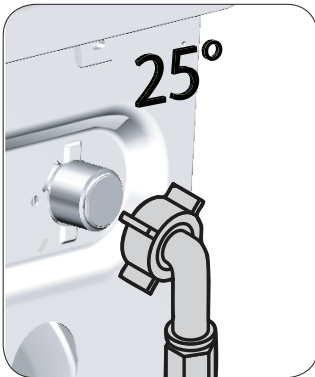

- a) Connect the straight end of the mains inlet hose provided with the product to the cold water tap and the warped end to the water inlet on the back of the product as shown in the figure.

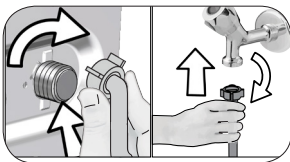

- b) Tighten all hose nuts by hand securely. Never use a tool when tightening the nuts.
- c) Open the taps completely after making the hose connection to check for water leaks at the connection points. If any leaks occur, turn off the tap and remove the nut. Retighten the nut carefully after checking the seal. Turn the tap on and repeat the checks.
- d) Keep the taps closed when the product is not in use.

6.5 Connecting the water draining hose to the drain



CAUTION!

- Attach the end of the drain hose directly to waste water drain, washbasin or bathtub.
- Do not contact the discharged water. Risk of being burnt as the water may be hot.
- Fix the water drain hose end completely to prevent risk of dislocation.

- a) Connect the water drain hose to a minimum height of 40 cm and a maximum height of 100 cm.
- b) The product may fail if water drain hose is at or close to floor level (under 40 cm) as it would take water in and out continuously.
- c) The product may fail if water drain hose is placed higher than 100 cm as it cannot discharge water and water stays inside the product. Therefore, follow the heights described in the figure.

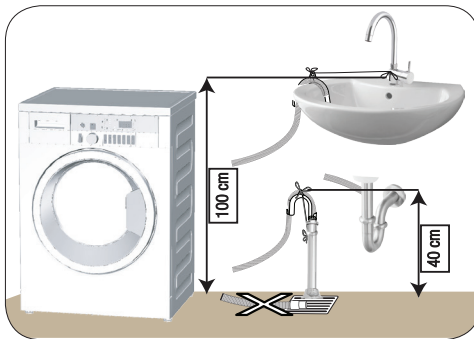

- d) To prevent the waste water to go back into the product again and to ensure easy drainage, do not immerse the end of the hose into the waste water or do not insert it into the drain for more than 15 cm. If it is too long, cut it short.
- e) The end of the hose should not be bent, it should not be stepped on and the hose must not be pinched between the drain and the product.
- f) If the length of the hose is too short, use it by adding an original extension hose. Total length of the hose may not be longer than 3.2 m. Otherwise, the product may fail as it would take water in and out continuously.

6.6 Adjusting the feet



CAUTION!

- Adjust feet so that the product will be balanced on the location it will be used.
 - Balance the machine by adjusting the feet.
 - Check for any play by pressing the product from upper diagonal edges.
 - Otherwise, the product may move from its place and cause crushing and vibration problems.
- Do not use any tools to loosen the lock nuts. Otherwise, the lock nuts may get damaged.

- a) Loosen the lock nuts on the feet by hand.
- b) Adjust the feet until the product stands level and balanced.
- c) Tighten all lock nuts again by hand.

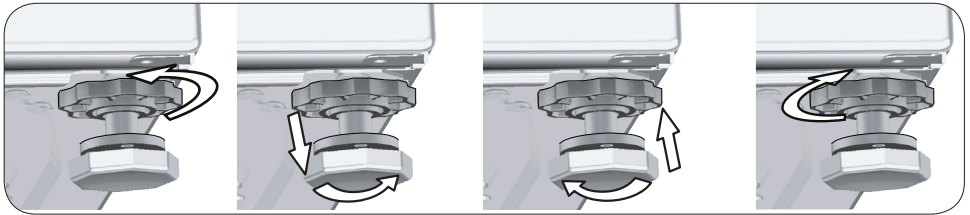

6.7 Electrical connection



DANGER!

- Damaged power cables must be replaced by the Authorised Service Agents.

a) Connect the product to a grounded outlet protected by a 16 A fuse.



NOTE

- Our company shall not be liable for any damages that will arise when the product is used without grounding in accordance with the local regulations.
- If the current value of the fuse or breaker in the house is less than 16 Amps, have a qualified electrician install a 16 Amp fuse.
- Do not make connections via extension cables or multi-plugs.

b) Connection must comply with national regulations.

c) The wiring for the electrical outlet circuit must be sufficient to meet the appliance requirements. Use of a Ground Fault Circuit Interrupter (GFCI) is recommended.

d) Power cable plug must be within easy reach after installation.

e) The voltage specified in the "(5.) Technical specifications" section must be equal to your mains voltage.

7. Initial use

7.1 Drum cleaning



NOTE

- Apply drum cleaning without any laundry in the product.

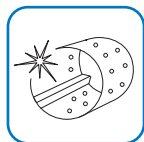

- a) Use the Drum Cleaning programme.
- b) Set the temperature to the level recommended on the special drum cleaning agent package which can be provided from Authorised Service Agents.
- c) Before starting the programme, put 1 pouch of special drum cleaning agent (if the special agent could not be supplied, put max. 1 teaspoon of (max. 100 g) of powder anti-limescale) into the main wash detergent compartment. If the anti-limescale is in tablet form, put only one tablet into the main wash compartment.
- d) Start the programme.
- e) Dry the inside of the bellow with a clean piece of cloth after the programme has come to an end.





































NOTE

- Repeat Drum Cleaning every 2 months.

8. Preparing to wash

8.1 Sorting the laundry

- a) Sort laundry according to type of fabric, colour, and degree of soiling and allowable water temperature.
- a) Follow instructions on the garment tags.
- a) Do not wash colours and whites together. New and dark coloured cottons may release a lot of dye.

LAUNDRY WASH SYMBOLS												
 WASH	Symbols for washing on machine											
	Water temperatures	Maximum	95°C	70°C	60°C	50°C	40°C	30°C				
		Symbol(s)	•••	•••	••	•••	••	•				
 DRYING	Drying symbols											
	Drying settings											
		At any temperature	At high temperature	At medium temperature	At low temperature	Without heating	Hang to dry	Lay to dry	Hang wet to dry	Lay in shadow to dry	Dry-cleanable	
 IRON	Iron											
	Dry or steam		Iron at high temperature	Iron at medium temperature	Iron at low temperature	No ironing	Iron without steam					
		Maximum temperature		200 °C	150 °C			110 °C				
 BLEACH	 All bleaches are allowed	 Bleach (sodium hypochlorite) can be used	 Bleach is not allowed	 Only bleaches without chlorine are allowed								

8.2 Preparing laundry for washing

- a) Remove the metal pieces such as support wire, belt buckle or metal buttons or wash the clothes by putting them in a laundry bag or pillow case.
- b) Take out all substances in the pockets such as coins, pens and paper clips, and turn pockets inside out before washing.
- c) Put small size clothes such as infant's socks and nylon stockings in a laundry bag or pillow case.
- d) Close zipper and fasten the buttons.
- e) Wash products with hand-washable or other tags only with an appropriate programme.
- f) Tough stains must be treated properly before washing.
- g) Wash trousers and delicate laundry turned inside out.
- h) Laundry that are subjected to materials such as flour, lime dust, milk powder, etc. intensely must be shaken off before placing into the product.

8.3 Loading and removing the laundry

- a) Open the loading door.
- b) Do not pack laundry inside the product tightly.
- c) Push the loading door to close until you hear a locking sound.
- d) Take care not to jam any clothing into the door. Loading door will be locked after the programme has started.
- e) The door lock will open immediately after the washing programme has ended. Then you can open the loading door. If the door does not open, apply the solutions provided for "Loading door cannot be opened." error in the Troubleshooting section.

8.4 Using detergent

8.4.1 Detergent drawer

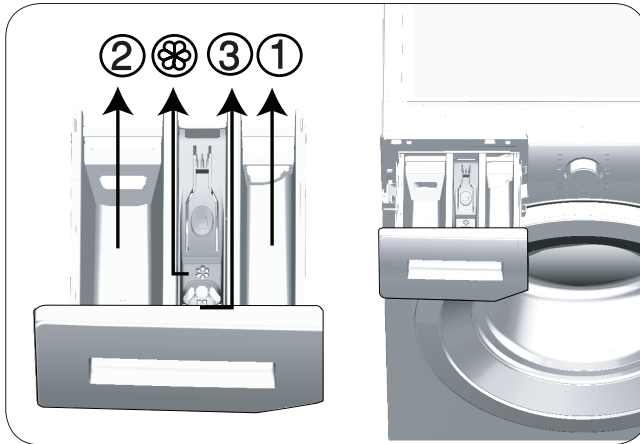

The detergent drawer is composed of three compartments:

- (1) for prewash
- (2) for main wash
- (3) for softener

- (⊗) in addition, there is a siphon piece in the softener compartment.

8.4.2 Detergent, softener and other cleaning agents

- a) Add detergent and softener before starting the washing programme.
- b) When using a programme without prewash, do not put any detergent into the prewash compartment.
- c) Do not select a programme with prewash if you are using a detergent bag or dispensing ball. Place the detergent bag or the dispensing ball directly among the laundry in the product.
- d) Never leave the detergent drawer open while the washing programme is running!

8.4.3 Choosing the detergent



CAUTION!

- Do not use soap powder.
- Use only detergents manufactured specifically for washing machines.



NOTE

- Detergent type to be used depends on the fabric type and colour.

- a) Use different detergents for coloured and white laundry.
- b) Wash your delicate clothes only with special detergents (liquid detergent, wool shampoo, etc.) used solely for delicate clothes.
- c) When washing dark coloured clothes and quilts, it is recommended to use liquid detergent.
- d) Wash woolens with special detergent manufactured specifically for woolens.

8.4.4 Adjusting detergent amount

- a) The amount of washing detergent to be used depends on the amount of laundry, the degree of soiling and water hardness.
- b) Do not use amounts exceeding the dosage quantities recommended on the detergent package to avoid excessive foam and poor rinsing.
- c) Use lesser detergent for small amounts or lightly soiled clothes.

8.4.5 Using liquid or gel detergent

- a) Do not forget to place the liquid detergent cup into the main wash compartment.
- b) If the liquid detergent has lost its fluidity, dilute it with water before putting it in the detergent cup.
- b) When using gel detergent, fill the detergent into this cup before starting the programme.

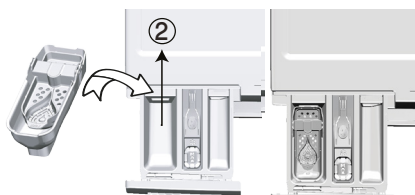

8.4.6 Using tablet and capsule liquid detergents

- a) If tablet is a capsule with liquid detergent, put it directly into the drum before washing.
- b) Put tablet detergents into the main wash compartment or directly into the drum before washing.

8.4.7 Using softeners

- a) Pour the softener into the softener compartment of the detergent drawer.
- b) Do not exceed the (> max <) level marking in the softener compartment.
- c) If the softener has lost its fluidity, dilute it with water before adding it in the detergent compartment.



- Do not use liquid detergents or other cleaning products other than fabric softeners produced for washing machines to soften the clothes.

WARNING!

8.4.8 Using starch

- a) Place liquid or dust starch on softener compartment and start the rinsing programme.
- b) Do not use softener and starch together.
- c) Use drum cleaning described in Initial use section after using starch.

8.4.9 Using limescale remover

- a) When required, use limescale removers manufactured specifically for washing machines only.

8.4.10 Using bleaches

- a) Choose a programme with prewash. Put bleach in prewash compartment while the product is taking water in at the start of prewash.
- b) Do not use bleaching agent and detergent by mixing them.
- c) Use just a little amount (50 ml) of bleaching agent and rinse the clothes very well as it causes skin irritation.
- d) Do not pour the bleach onto the laundry.
- e) Do not use it with the coloured items.
- f) When using oxygen based bleaches, select a programme that washes at a lower temperature.
- g) Oxygen-based bleach can be used together with the detergent.

9. Programmes and auxiliary functions

9.1 Programme selection



NOTE

- Programmes are limited with the highest spin speed appropriate for that particular type of fabric.
- When selecting a programme, always consider the type of fabric, colour, degree of soiling and permissible water temperature.
- Always select the relevant lowest required temperature. Higher temperature means higher electricity consumption.

a) Select the desired programme with the Programme Selection knob.

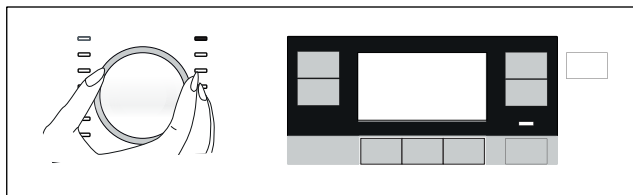

NOTE

- If no programme is started or no key is pressed within 10 minute during programme selection process, the product will turn off automatically. Display and all indicators will turn off.
- If you press on the On / Off button, the programme information set as default will be displayed.

9.2 Programmes



NOTE

- You can see laundry type and washing suggestions on clothing tags.

• Cottons Eco



Use to wash your normally soiled, durable cotton and linen laundry. Although it washes longer than all other programmes, it provides high energy and water savings. Actual water temperature may be different from the stated wash temperature. When you load the machine with less laundry (e.g. ½ capacity or less), periods in programme stages may automatically get shorter. In this case, energy and water consumption will decrease more, providing a more economic wash.



NOTE

- Actual water temperature may be different from the stated wash temperature.

• Cottons



You can wash your durable cotton laundry (sheets, bedlinen, towels, bathrobes, underwear etc.) in this programme.

When "Quick Wash" button is pressed, efficient washing performance will be delivered thanks to the intense washing movement even though the programme duration will be significantly shorter. When "Quick Wash" button is not pressed, superior washing and rinsing performance will be delivered for your heavily soiled laundry.

• Synthetics



You can wash your synthetic laundry (such as shirts, blouses, synthetic/cotton blended fabrics etc.) in this programme.

When "Quick Wash" button is pressed, the programme duration will be significantly shorter and the washing performance will be high. When "Quick Wash" button is not pressed, superior washing and rinsing performance will be delivered for your soiled laundry.

• Woollens / Hand Wash



Use to wash your woolen/delicate laundry. Select the appropriate temperature complying with the tag of your clothes. Your laundry will be washed with a very gentle washing action in order not to damage the clothes.



APPAREL CARE

Woolens programme of this machine is approved by The Woolmark Company for washing machine-washable woolen products provided that the products are washed in accordance with the instructions on the product tag and the instructions published by the manufacturer of this machine. M1325
In the UK, Ireland, Hong Kong and India, the Woolmark trademark is a Certification trademark.

• Hygiene+



Use this programme for your laundry (baby clothes, bed sheets, bedlinen, underwear, etc. cotton items) for which you require an anti-allergic and hygienic washing at high temperature with intensive and long washing cycle. The high level of hygiene is ensured thanks to long heating duration and additional rinsing step.

- Programme was tested by the "VDE" institute with the 20°C temperature option selected and it was certified in terms of its efficacy in eliminating bacteria and mould.
- Programme was tested by "The British Allergy Foundation" (Allergy UK) with the 60°C temperature option selected and it was certified in terms of its efficacy in eliminating allergens in addition to bacteria and mould.



Allergy UK is the brand of the British Allergy Association. Seal of Approval is created to guide people that require recommendation about a product that the related product restricts / reduces / eliminates the allergens or reduces the allergen content significantly in the ambient where allergy patients exist. It aims to provide assurance that the products are tested scientifically or examined in a way to provide measurable results.

• Dark Care / Jeans



Use this programme to protect the colour of your dark-coloured garments or jeans. It performs high performance washing with special drum movement even if the temperature is low. It is recommended to use liquid detergent or woolen shampoo for dark coloured laundry. Do not wash your delicate clothes containing wool or etc.

• Outdoor / Sports



You can use this programme to wash sports and outdoors garments that contain cotton/synthetics mix and water repellent covers such as gore-tex etc. It makes sure your garments are washed gently thanks to special rotating movements.

• Spin+Drain



Use to drain the water in the product.

• Rinse



Use when you want to rinse or starch separately.

• Shirts



This programme is used to wash the shirts made from cotton, synthetic and synthetic blended fabrics altogether. It reduces wrinkles. When "Quick Wash" setting button is pressed, the Pre-treatment algorithm is executed.

- Apply the pre-treatment chemical on your garments directly or add it together with detergent when the machine starts to take water from the main washing compartment. Thus, you can obtain the same performance as you obtain with normal washing in a much shorter period of time. Usage life of your shirts increases.

• Mix 40



Use to wash your cotton and synthetic clothes together without sorting them.

• Gentle Care



You can wash your delicate clothes such as cotton/synthetic blended knitwear or hosiery in this programme. It washes with more delicate washing action. Wash your clothes whose colour you want to preserve either at 20 degrees or by selecting the cold wash option.

• Daily Xpress / Xpress Super Short



Use this programme to wash your lightly soiled and unspotted cotton clothes in a short time. When the "Quick Wash" setting button is pressed, programme duration can drop to 14 minutes. 2 (two) kg of laundry must be washed maximum.

• StainExpert



The machine has a special stain programme which enables the removal of different types of stains in the most effective way. Use this programme only for durable colourfast cotton laundry. Do not wash delicate and pigmenting clothes and laundry in this programme. Before washing, garment tags should be checked (recommended for cotton shirts, trousers, shorts, t-shirts, baby clothes, pyjamas, aprons, table clothes, bed sheets, duvet covers, pillowcases, bath-beach towels, towels, socks, cotton underwear that are suitable for washing at high temperature and long time). You can perform washing for 24 types of stain divided into 3 different groups that can be selected with the "Quick Wash" setting button. Below you can see the stain groups that can be selected using the "Quick Wash" setting button. Depending on the selected stain group, a special washing programme for which duration of rinse hold, washing action, washing and rinsing duration are modified.

Below you can find the soil groups that can be selected with the "Quick Wash" setting button:

When "Quick Wash" is not selected	Sweat
	Collar soil
	Meal
	Mayonnaise
	Salad dressing
	Make-up
	Machine oil
	Baby food

When the "Quick Wash" button is pressed once	Blood
	Chocolate
	Pudding
	Grass
	Mud
	Egg
	Butter
	Curry

When the "Quick Wash" button is pressed twice	Tea
	Coffee
	Fruit juice
	Ketchup
	Red wine
	Starch
	Jam
Coal	

- Select the stain programme.
- Select the stain you want to clean by locating it in the groups above and using the "Quick Wash" setting button. For detailed information, see the Programme settings section.
- Read the garment tag carefully and ensure that correct temperature and spin speed are selected.

• Down Wear



Use this programme to wash your coats, vest, jackets etc. containing feathers with a "machine-washable" label on them. Thanks to special spinning profiles, it is ensured that the water reaches the air gaps amongst the feathers.

• Lingerie





You can use this programme to wash delicate garments that are suitable for hand wash and delicate women's underwear. Small amount of garments must be washed in a washing net. Hooks, buttons etc. must be done up and zips must be zipped up.

9.3 Programme table

EN					Auxiliary functions					
Programme		Max. Load (kg)	Water Consumption (l)	Energy Consumption (kWh)	Max. Speed***	Prewash	Night Mode	Extra Rinse	Anti-Creasing+	Selectable temperature range °C
Cottons	90	8	94	2,40	1400	•	•	•	•	Cold-90
	60	8	94	1,70	1400	•	•	•	•	Cold-90
	40	8	92	0,85	1400	•	•	•	•	Cold-90
	20	8	92	0,55	1400	•	•	•	•	Cold-90
Cottons Eco	60**	8	44	0,915	1400					Cold-60
	60**	4	40,5	0,710	1400					Cold-60
	40**	4	40,5	0,630	1400					Cold-60
Synthetics	60	3	65	1,20	1200	•	•	•	•	Cold-60
	40	3	63	0,78	1200	•	•	•	•	Cold-60
Daily Xpress / Xpress Super Short	90	8	69	2,10	1400		•	•	•	Cold-90
	60	8	69	1,05	1400		•	•	•	Cold-90
	30	8	66	0,15	1400		•	•	•	Cold-90
Daily Xpress / Xpress Super Short + Express	30	2	36	0,15	1400		•	•	•	Cold-30
Mix 40	40	3,5	71	0,80	800	•	•		•	Cold-40
Woolens / Hand Wash	40	1,5	52	0,46	1200		•	•		Cold-40
Gentle Care	40	3,5	52	0,58	800		•	•		Cold-40
Down Wear	60	2	84	0,80	1000		•	•		Cold-60
Outdoor / Sports	40	3,5	52	0,40	1200	•				Cold-40
Dark Care / Jeans	40	3,5	83	0,85	1200	•	•	*	•	Cold-40
StainExpert	60	4	85	1,50	1400	•				30-60
Shirts	60	3	59	1,10	800	•		•	•	Cold-60
Hygiene+	90	8	110	2,30	1400			*		20-90
Lingerie	30	1	68	0,30	600			*		Cold-30
Drum Cleaning	70	-	72	2,15	600					70

- : Selectable.
- * : Automatically selected, cannot be cancelled.
- ** : Energy Label programme (EN 60456 Ed.3)
- *** : If maximum spin speed of the product is lower then this value, you can only select up to the maximum spin speed.
- : See the programme description for maximum load.

** "Cotton Economic 40°C" and "Cotton Economic 60°C" are standard programmes. These programmes are known as "40°C cotton standard programme" and "60°C cotton standard programme" and indicated with the   symbols on the panel.



NOTE

- Water and power consumption may vary from the above table subject to the changes in water pressure, water hardness and temperature, ambient temperature, type and amount of laundry, selection of auxiliary functions and spin speed, and changes in electric voltage.
- You can see the washing duration on the display of your machine while selecting a programme. Depending on the amount of laundry you have loaded into your machine, there may be a difference of 1-1.5 hours between the duration shown on the display and the actual duration of the wash cycle. Duration will be automatically updated soon after the washing starts.
- Auxiliary function selection modes can be changed by the manufacturing company. Existing selection modes can be removed or new selection modes can be added.
- "The manufacturer reserves the right to make modifications in the programmes and auxiliary functions given in the table. While these modifications will not change the product performance, programme steps and durations can change."

Indicative values for Synthetics programmes (EN)

	Load (kg)	Water Consumption (l)	Energy Consumption (kWh)	Programme Duration (min)*	Remaining Moisture Content (%)**	Remaining Moisture Content (%)**
					≤ 1000 rpm	> 1000 rpm
Synthetics 60	3	65	1,20	115/150	45	40
Synthetics 40	3	63	0.78	115/150	45	40

You can see the washing time of the programme you have selected on the display of the machine. It is normal that * small differences may occur between the time shown on the display and the real washing time

Remaining moisture content values may differ according to the selected spin speed **

9.4 Auxiliary function selection



NOTE

- When you try to change an auxiliary function that is not allowed to be selected with the current programme, indicator light of the relevant auxiliary function will not flash, only an audio warning is given. Frames of available options will be lit.
- If a second auxiliary function conflicting with the first one is selected before starting the product, the function selected first will be cancelled and the second auxiliary function selection will remain active.
- An auxiliary function that is not compatible with the programme cannot be selected. (See "Programme and consumption table")
- Some programmes have auxiliary functions that must be operated simultaneously. Those functions cannot be cancelled. The frame of the auxiliary function will not be illuminated, only inner area will be illuminated.

- a) Select the desired auxiliary functions before starting the programme.
- b) Light of the selected auxiliary function turns on.

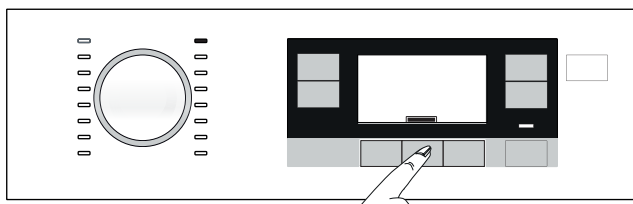

NOTE

- You may select or cancel auxiliary functions suitable for the current programme after the washing has started. If the wash cycle has reached a point where no auxiliary function can be selected, an audio warning will be given.

9.4.1 Auxiliary functions

• Prewash

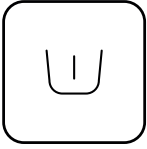

A Prewash is only worthwhile for heavily soiled laundry. Not using the Prewash will save energy, water, detergent and time.

• Extra Rinse



This function enables the product to make another rinsing in addition to the one already made after the main wash. Thus, the risk for sensitive skins (babies, allergic skins, etc.) to be effected by the minimal detergent remnants on the laundry can be reduced.

• Night Mode



Use to wash the cottons with lesser energy consumption and silently. Spin steps are cancelled for a silent washing and the cycle ends with the Rinse Hold step. After completion of the programme, run Spin cycle to spin the laundry.

9.4.2 "Functions/Programmes Selected by Pressing the Function Buttons for 3 Seconds"

• Drum Cleaning



CAUTION!

- This is not a Laundry washing programme. It is a maintenance programme.
- Do not run this programme when there are any objects in the machine. If you try to do so, the machine detects that there is a load inside and aborts the programme.



Press and hold the auxiliary function button 1 for 3 seconds to select the programme.
Use regularly (once in every 1-2 months) to clean the drum and provide the required hygiene. Operate the programme while the machine is completely empty. To obtain better results, put powder lime-scale remover for washing machines into the detergent compartment no. "2". When the programme is over, leave the loading door ajar so that the inside of the machine gets dry.

• Anti-Creasing+

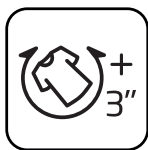

This function is selected when the 3rd auxiliary function is pressed and held for 3 seconds and the programme follow-up light for the relevant step turns on. When the function is selected, the drum rotates for up to 8 hours for preventing the laundry from creasing at the end of the programme. You can cancel the programme and take your laundry out at any time during the 8-hour duration. Press the function selection key or the machine on/off key to cancel the function. The programme follow-up light will remain on until the function is canceled or the step is complete. If the function is not cancelled, it will be active in the subsequent washing cycles as well.

• Child lock

Use Child Lock function to prevent children from tampering with the product. Thus you can avoid any changes in a running programme.



- You can switch on and off the product with On / Off button when the Child Lock is active. When you switch on the product again, programme will resume from where it has stopped.

To activate the Child Lock:



- Press and hold 2nd auxiliary function button for 3 seconds.
- Programme selection display on the panel will count down from 3.
- The "symbol" on programme selection display on the panel will appear.

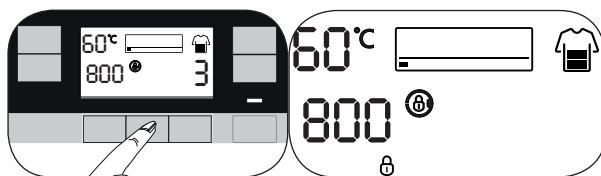

To deactivate the Child Lock:

- Press and hold 2nd auxiliary function button for 3 seconds.
- Programme selection display on the panel will count down from 3.
- The "symbol" on programme selection display on the panel will disappear.

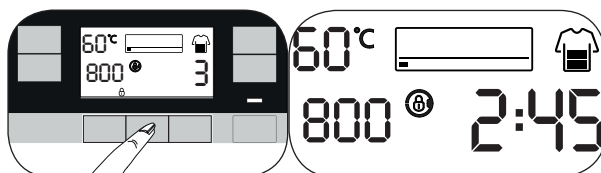

10. Programme setting

10.1 Temperature selection



- a) Whenever a new programme is selected, the recommended temperature for the selected programme appears on the temperature indicator.
- b) To decrease the temperature, press the Temperature Adjustment button. Temperature will decrease gradually.
- c) It turns back to the beginning after "Cold" option and arrives at the highest temperature selectable according to the programme.

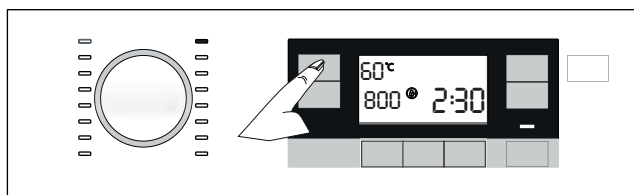

10.2 Spin speed selection

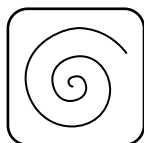

- a) Whenever a new programme is selected, the recommended spin speed of the selected programme is displayed on the spin speed indicator.
- b) To decrease the spin speed, press the Spin Speed Adjustment button. Spin speed decreases gradually.
- c) Maximum speed allowed for the relevant programme appears after pressing again.

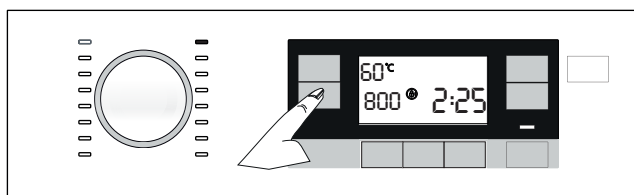

- d) "Rinse Hold" and "No Spin" options are shown after speed levels.

• Rinse Hold



If you are not going to unload your clothes immediately after the programme completes, you can use rinse hold function to keep your laundry in the final rinsing water in order to prevent them from getting wrinkled when there is no water in the machine. Press Start / Pause button after this process if you want to drain the water without spinning your laundry. Programme will resume and completes after draining the water. If you want to spin the laundry held in water, adjust the spin speed and press Start / Pause button. The programme resumes. Water is drained, laundry is spun and the programme is completed.

• No Spin



Use this function if you do not want your clothes be spun at the end of the programme.

10.3 Quick Wash Setting (Express)

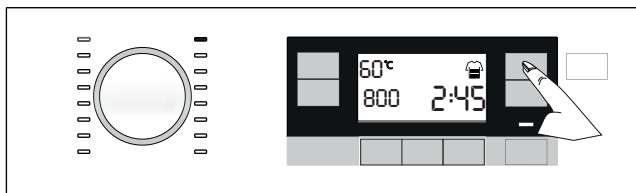

After selecting a programme, you can press the Quick Wash setting key to shorten the programme duration. For some programmes, the duration can shorten by over 50%. Despite this, the washing performance is good thanks to the changed algorithm.

Although it varies in each programme, when you press the Quick Wash key once, the programme duration decreases to a certain level, and when you press the same key for the second time, it drops to the minimum level. For a better washing performance, do not use the Quick Wash setting key when washing heavily soiled laundry.

Shorten the programme duration by using the Quick Wash key for Moderately and Slightly soiled laundry.



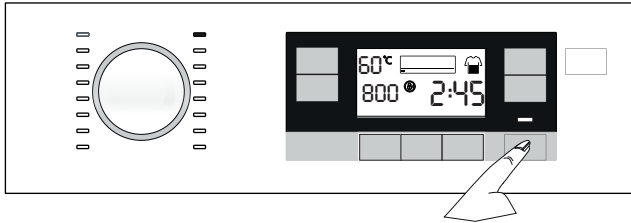

10.4 Starting the programme

- a) Press Start / Pause button to start the programme.
- b) Programme follow-up light showing the startup of the programme will turn on.



10.5 Programme steps

- a) The symbols below appear on programme follow-up indicator after the programme starts.

-  - Wash
-  - Rinse
-  - Spin
-  - End
-  - Anti-creasing+ (Once the relevant function has been selected, this symbol becomes on and remains on until it is cancelled. See "Functions/Programmes Selected by Pressing the Function Buttons for 3 Seconds")

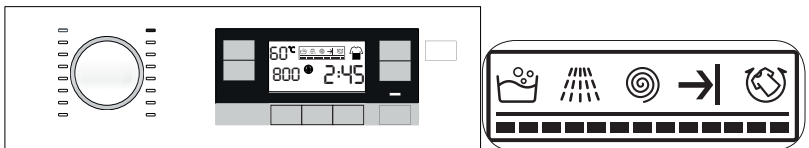

NOTE

- "No Water" symbol appears if water is not supplied to the product. Programme steps do not continue.



10.6 End of programme



- a) "End" symbol appears on the display when the programme is complete.

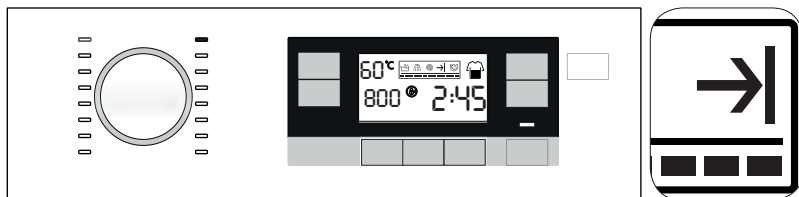

NOTE

- If you do not press any button for 10 minutes, the product will turn off automatically. Display and all indicators are turned off.
- Completed programme steps will be displayed if you press On / Off button.

- b) Remove your laundry.
- c) Switch off the product by pressing and holding the On/Off button for 3 seconds.
- d) Close the tap connected to the product.
- e) Unplug the product.

11. Programme options

11.1 Setting the end time



NOTE

- Do not use liquid detergents without a liquid cup when you activate End Time function. There is the risk of staining of the clothes.
- When the End Time selection is completed, the time appears on the display is the end time chosen plus the duration of the selected programme.



- a) With the End Time function, the startup of the programme can be delayed up to 24 hours. After pressing End Time button, the programme's estimated ending time is displayed. If the End Time is adjusted, End Time indicator is illuminated.

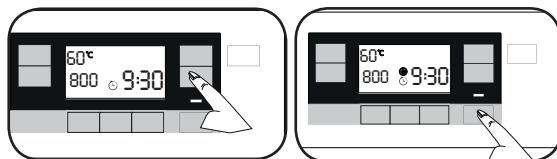

- b) Open the loading door, place the laundry and put detergent, etc.
- c) Select the washing programme, temperature, spin speed and, if required, the auxiliary functions.
- d) Set the end time of your choice by pressing the End Time button. End Time indicator illuminates.
- e) Close the loading door.
- f) Press the Start / Pause button. Time countdown starts. ":" symbol in the middle of the end time on the display starts flashing and the loading door locks down.



NOTE

- The product enters standby mode 10 sec after pressing Start / Pause button if the loading door is not closed and End Time Setting Symbol indicator and Start / Pause light starts flashing.

Adding laundry during End Time countdown.

- Press the Start / Pause button.
- The loading door will open and the door symbol on the display will go off.
- Open the loading door and add laundry.
- Close the loading door.
- Press the Start / Pause button.

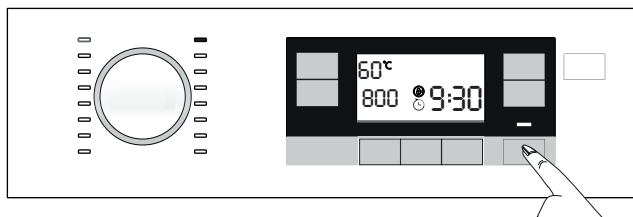

11.1.1 Cancelling the end time setting

- If you want to cancel End Time function, press On / Off button for 3 sec. to turn off and on the product.

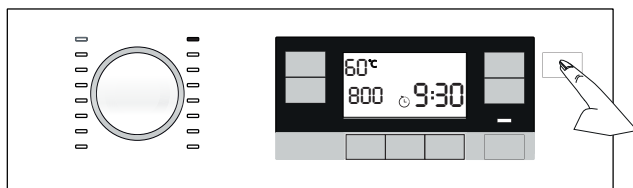

11.2 Switching the machine to standby mode and adding laundry

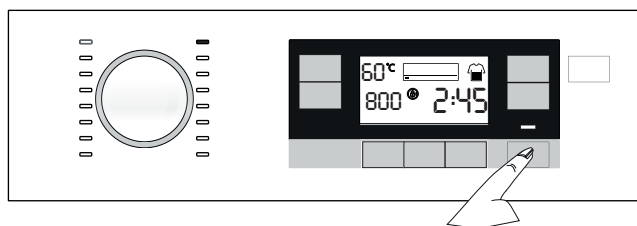

- Press the Start/Pause button to switch the machine to pause mode while a programme is running.
- Start/Pause light and the programme step light in the programme follow-up indicator will start flashing.

- c) If the water level in the machine is suitable, the door lock will be deactivated and the door will open, allowing you to add garments. The door lock icon on the display goes off when the door lock is deactivated.
- d) After adding garments, close the door and press Start/Pause button once again to resume the washing cycle.
- e) If the water level in the machine is not suitable when you press Start/Pause button, the door lock cannot be deactivated and the door lock icon on the display remains on.



NOTE

- If the temperature of the water inside the machine is above 50°C, you cannot deactivate the door lock for safety reasons, even if the water level is suitable.

11.3 Cancelling the programme

- a) Press and hold On / Off button for 3 seconds.



NOTE

- If you press On / Off button when the Child Lock is enabled, the programme will not be cancelled. You should cancel the child lock first. See To deactivate the child lock.
- If you want to open the loading door after you have cancelled the programme but it is not possible to open the loading door since the water level in the product is above the loading door opening, then turn the Programme Selection knob to Pump+Spin programme and discharge the water in the product.

- b) Programme selection display on the panel will count down as "3, 2, 1".
- c) The programme is cancelled.

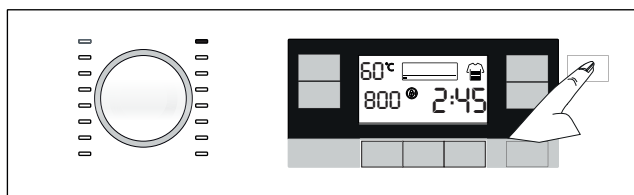

12. Additional features

12.1 Activating and deactivating the audio warning

- Press and hold 1st and 2nd auxiliary function buttons for 3 seconds to activate and deactivate the audio warning.
- Programme selection display on the panel will count down as "3, 2, 1".
- If the audio warning is active it will be deactivated and vice versa.

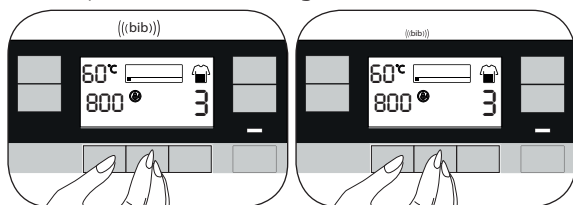

12.2 Loading door lock



- Press Start / Pause button to lock the loading door for safety purposes after starting any process.
- The door will not unlock if the product contains enough water to spill out when the door is opened.
- "Door Locked" symbol appears when the loading door is locked.

12.2.1 Opening the loading door in case of power failure:



NOTE

- In case of power failure, you can use the loading door emergency handle under the pump filter cap to open the loading door manually.



WARNING!

- To avoid any water overflow before opening the loading door, make sure there is no water left inside the machine.

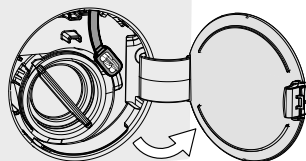

a) Open the pump filter cap.

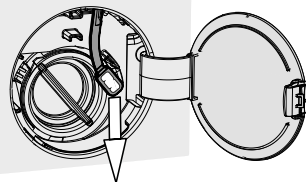

- b) Release the loading door emergency handle located at the rear side of the filter cap.
- c) Pull down the loading door emergency handle once and open the loading door. After opening the loading door, re-insert the loading door emergency handle.
- d) If the loading door does not open, try again by pulling down the handle.

12.3 Drum Illumination

Drum illumination lamp of your machine will light up during programme selection. The light will turn off when you start the programme. If no programme is started or no key is pressed within 10 minutes during programme selection process, the drum illumination lamp will turn off.

Drum illumination lamp of your machine will light up 1-2 minutes after the programme is completed. It will go off when you press the On/Off button. The drum illumination lamp will turn off if you do not press any button within 10 minutes after the programme has ended.

13. Maintenance and cleaning

13.1 Cleaning the detergent drawer



NOTE

- Clean the detergent drawer at regular intervals (every 4-5 washing cycles) as shown below in order to prevent accumulation of powder detergent in time.
- If more than normal amount of water and softener mixture starts to gather in the softener compartment, the siphon must be cleaned.



- a) Press the dotted point on the siphon in the softener compartment and pull and remove the detergent drawer towards yourself.
- b) Lift the rear part of the siphon to remove it as illustrated.
- c) Wash the detergent drawer and the siphon with plenty of lukewarm water in a washbasin. In order to prevent the residues to contact your skin, clean it with an appropriate brush by wearing a pair of gloves.
- d) Place the siphon back into its seat securely after cleaning and insert the drawer back.

13.2 Cleaning the loading door



- a) After every washing check that no foreign substance is left in the drum.
- b) If the holes on the bellow shown in the figure are blocked, open the holes using a toothpick.
- c) Foreign metal substances will cause rust stains in the drum. Clean the stains on the drum surface by using cleaning agents for stainless steel.
- d) Never use steel wool or wire wool. These will damage the painted, chromated and plastic surfaces.

13.3 Cleaning the body and control panel

- a) Wipe the body of the product with soapy water or non-corrosive mild gel detergents as necessary, and dry with a soft cloth.
- b) Use only a soft and damp cloth to clean the control panel.

13.4 Cleaning the water intake filters

There is a filter at the end of each water intake valve at the rear of the product and also at the end of each water intake hose where they are connected to the tap. These filters prevent foreign substances and dirt in the water to enter the product. Filters should be cleaned if they are dirty.

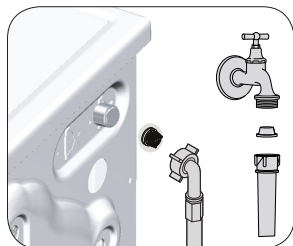

- a) Close the taps.
- b) Remove the nuts of the water intake hoses to access the filters on the water intake valves. Clean them with an appropriate brush. If the filters are too dirty, remove them from their places with a pliers and clean in this way.
- c) Take out the filters on the flat ends of the water intake hoses together with the gaskets and clean thoroughly under running water.
- d) Replace the gaskets and filters carefully in their places and tighten the hose nuts by hand.

13.5 Cleaning the pump filter



CAUTION!

- Foreign substances left in the pump filter may damage your product or may cause noise problem.
- In regions where freezing is possible, the tap must be closed, system hose must be removed and the water inside the product must be drained when the product is not in use.



NOTE

- After each use, turn off the tap to which the mains hose is connected.

The filter system in your product prevents solid items such as buttons, coins and fabric fibers clogging the pump impeller during draining of washing water. Thus, the water will be drained without any problem and the service life of the pump will extend.

If the product fails to drain water inside it, the pump filter is clogged. Filter must be cleaned whenever it is clogged or in every 3 months. Water must be drained off first to clean the pump filter.

13.5.1 Cleaning dirty filters



CAUTION!

- Temperature of the water inside the product may rise up to 90 °C. To avoid the risk of scalding, clean the filter after the water inside the product has cooled down.

- a) Unplug the product.
- b) Open the filter cap.

Open the filter cap.

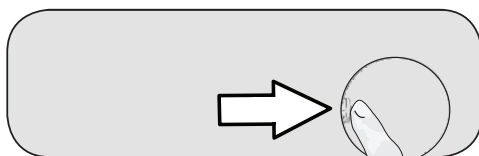

- c) Proceed as follows for draining water.

- Place a large container in front of the filter to catch water from the filter.
- Loosen pump filter by turning it counterclockwise until water starts to flow. Fill the flowing water into the container you have placed in front of the filter. Always keep a piece of cloth handy to absorb any spilled water.
- Turn and remove the pump filter completely when water inside the product is completely drained.

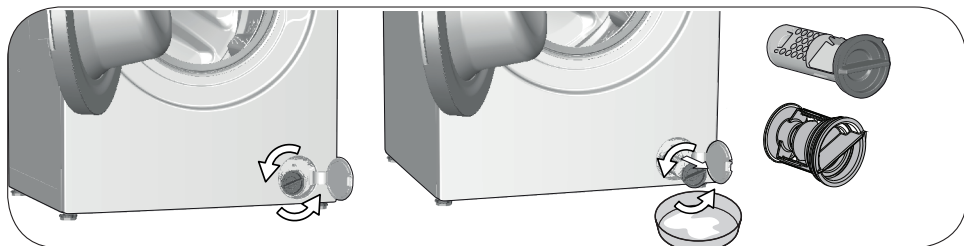

- d) Clean any residues inside the filter as well as fibers, if any, around the pump impeller region.
- e) Install the filter.
- f) Close the filter cover.

14. Troubleshooting

Problem	Cause	Solution
Programs do not start after the loading door is closed.	Start / Pause / Cancel button is not pressed.	• Press Start / Pause / Cancel button.
	It may be difficult to close the loading door in case of excessive loading.	• Reduce the amount of laundry and make sure that the loading door is closed properly.
Programme cannot be started or selected.	The product has switched to self protection mode due to a supply problem (line voltage, water pressure, etc.).	• The programme is cancelled when the product is turned off and on again. Press and hold On / Off button for 3 seconds.
Water inside the product.	Some water has remained in the product due to the quality control processes in the production.	• This is not a failure; water is not harmful to the product.
The product does not take water in.	Tap is turned off.	• Turn on the taps.
	Water inlet hose is bent.	• Flatten the hose.
	Water inlet filter is clogged.	• Clean the filter.
	Loading door is not closed.	• Close the door.
The product does not drain water.	Water drain hose is clogged or twisted.	• Clean or flatten the hose.
	Pump filter is clogged.	• Clean the pump filter.
Product vibrates or makes noise.	Product is standing unbalanced.	• Stable the product by adjusting the feet.
	A hard substance has entered into the pump filter.	• Clean the pump filter.
	Transportation safety bolts are not removed.	• Remove the transportation safety bolts.
	Laundry quantity in the product is too little.	• Add more laundry to the product.
	Excessive laundry is loaded in the product.	• Take out some of the laundry from the product or distribute the load by hand to balance it homogeneously in the product.
	Product is leaning on a rigid item.	• Make sure that the product is not leaning on anything.
There is water leaking from the bottom of the product.	Water drain hose is clogged or twisted.	• Clean or flatten the hose.
	Pump filter is clogged.	• Clean the pump filter.
Product stopped shortly after the programme started.	Machine has stopped temporarily due to low voltage.	• Product will resume running when the voltage restores to the normal level.
Product directly drains the water it takes in.	Draining hose is not at adequate height.	• Connect the water draining hose as described in the user manual.

Problem	Cause	Solution
No water can be seen in the product during washing.	Water is inside the invisible part of the product.	<ul style="list-style-type: none"> • This is not a failure.
Loading door cannot be opened.	Loading door lock is activated because of the water level in the product.	<ul style="list-style-type: none"> • Drain the water by running the Pump or Spin programme.
	Product is heating up the water or it is at the spinning cycle.	<ul style="list-style-type: none"> • Wait until the programme completes.
	Loading door may be stuck because of the pressure it is subjected to.	<ul style="list-style-type: none"> • Grab the handle and push and pull the loading door to release and open it.
	If there is no power, loading door of the product will not open.	<ul style="list-style-type: none"> • To open the loading door, open the pump filter cap and pull down the emergency handle positioned at the rear side of the said cap. See "Opening the loading door in case of power failure"
Washing takes longer than specified in the user manual.(*)	Water pressure is low.	<ul style="list-style-type: none"> • Product waits until taking in adequate amount of water to prevent poor washing quality due to the decreased amount of water. Therefore, the washing time extends.
	Voltage is low.	<ul style="list-style-type: none"> • Washing time is prolonged to avoid poor washing results when the supply voltage is low.
	Input temperature of water is low.	<ul style="list-style-type: none"> • Required time to heat up the water extends in cold seasons. Also, washing time can be lengthened to avoid poor washing results.
	Number of rinses and/or amount of rinse water have increased.	<ul style="list-style-type: none"> • Product increases the amount of rinse water when good rinsing is needed and adds an extra rinsing step if necessary.
	Excessive foam has occurred and automatic foam absorption system has been activated due to too much detergent usage.	<ul style="list-style-type: none"> • Use recommended amount of detergent.
Programme time does not countdown. (On models with display) (*)	Timer may stop during water intake.	<ul style="list-style-type: none"> • Timer indicator will not countdown until the product takes in adequate amount of water. The product will wait until there is sufficient amount of water to avoid poor washing results due to lack of water. Timer indicator will resume countdown after this.
	Timer may stop during heating step.	<ul style="list-style-type: none"> • Timer indicator will not countdown until the product reaches the selected temperature.
	Timer may stop during spinning step.	<ul style="list-style-type: none"> • Automatic unbalanced load detection system is activated due to the unbalanced distribution of the laundry in the product.

Problem	Cause	Solution
Programme time does not countdown. (*)	There is unbalanced load in the product.	<ul style="list-style-type: none"> • Automatic unbalanced load detection system is activated due to the unbalanced distribution of the laundry in the product.
Product does not switch to spinning step. (*)	There is unbalanced load in the product.	<ul style="list-style-type: none"> • Automatic unbalanced load detection system is activated due to the unbalanced distribution of the laundry in the product.
	The product will not spin if water is not drained completely.	<ul style="list-style-type: none"> • Check the filter and the draining hose.
	Excessive foam has occurred and automatic foam absorption system has been activated due to too much detergent usage.	<ul style="list-style-type: none"> • Use recommended amount of detergent.
Washing performance is poor: Laundry turns gray. (**)	Insufficient amount of detergent has been used over a long period of time.	<ul style="list-style-type: none"> • Use the recommended amount of detergent appropriate for water hardness and the laundry.
	Washing has been made at low temperatures for a long time.	<ul style="list-style-type: none"> • Select the proper temperature for the laundry to be washed.
	Insufficient amount of detergent is used with hard water.	<ul style="list-style-type: none"> • Using insufficient amount of detergent with hard water causes the soil to stick on the cloth and this turns the cloth into gray in time. It is difficult to eliminate graying once it happens. Use the recommended amount of detergent appropriate for water hardness and the laundry.
	Excessive amount of detergent is used.	<ul style="list-style-type: none"> • Use the recommended amount of detergent appropriate for water hardness and the laundry.
Washing performance is poor: Stains persist or the laundry is not whitened. (**)	Insufficient amount of detergent is used.	<ul style="list-style-type: none"> • Use the recommended amount of detergent appropriate for water hardness and the laundry.
	Excessive laundry is loaded in.	<ul style="list-style-type: none"> • Do not load the product in excess. Load with amounts recommended in the "Programme and consumption table".
	Wrong programme and temperature were selected.	<ul style="list-style-type: none"> • Select the proper programme and temperature for the laundry to be washed.
	Wrong type of detergent is used.	<ul style="list-style-type: none"> • Use original detergent appropriate for the product.
	Excessive amount of detergent is used.	<ul style="list-style-type: none"> • Put the detergent in the correct compartment. Do not mix the bleaching agent and the detergent with each other.
Washing performance is poor: Oily stains appeared on the laundry. (**)	Regular drum cleaning is not applied.	<ul style="list-style-type: none"> • Clean the drum regularly.

Problem	Cause	Solution
Washing performance is poor: Clothes smell unpleasantly. (**)	Odours and bacteria layers are formed on the drum as a result of continuous washing at lower temperatures and/or in short programmes.	<ul style="list-style-type: none"> • Leave the detergent drawer as well as the loading door of the product ajar after each washing. Thus, a humid environment favorable for bacteria cannot occur in the machine.
Colour of the clothes faded. (**)	Excessive laundry was loaded in.	<ul style="list-style-type: none"> • Do not load the product in excess.
	Detergent in use is damp.	<ul style="list-style-type: none"> • Keep detergents closed in an environment free of humidity and do not expose them to excessive temperatures.
	A higher temperature was selected.	<ul style="list-style-type: none"> • Select the proper programme and temperature according to the type and soiling degree of the laundry.
Washing machine does not rinse well.	The amount, brand and storage conditions of the detergent used are inappropriate.	<ul style="list-style-type: none"> • Use a detergent appropriate for the washing machine and your laundry. Keep detergents closed in an environment free of humidity and do not expose them to excessive temperatures.
	Detergent was put in the wrong compartment.	<ul style="list-style-type: none"> • If detergent is put in the prewash compartment although prewash cycle is not selected, the product can take this detergent during rinsing or softener step. Put the detergent in the correct compartment.
	Pump filter is clogged.	<ul style="list-style-type: none"> • Check the filter.
	Drain hose is folded.	<ul style="list-style-type: none"> • Check the drain hose.
Laundry became stiff after washing. (**)	Insufficient amount of detergent is used.	<ul style="list-style-type: none"> • Using insufficient amount of detergent for the water hardness can cause the laundry to become stiff in time. Use appropriate amount of detergent according to the water hardness.
	Detergent was put in the wrong compartment.	<ul style="list-style-type: none"> • If detergent is put in the prewash compartment although prewash cycle is not selected, the product can take this detergent during rinsing or softener step. Put the detergent in the correct compartment.
	Detergent was mixed with the softener.	<ul style="list-style-type: none"> • Do not mix the softener with detergent. Wash and clean the drawer with hot water.
Laundry does not smell like the softener. (**)	Detergent was put in the wrong compartment.	<ul style="list-style-type: none"> • If detergent is put in the prewash compartment although prewash cycle is not selected, the product can take this detergent during rinsing or softener step. Wash and clean the drawer with hot water. Put the detergent in the correct compartment.
	Detergent was mixed with the softener.	<ul style="list-style-type: none"> • Do not mix the softener with detergent. Wash and clean the drawer with hot water.

Problem	Cause	Solution
Detergent residue in the detergent drawer. (**)	Detergent was put in wet drawer.	• Dry the detergent drawer before putting in detergent.
	Detergent has gotten damp.	• Keep detergents closed in an environment free of humidity and do not expose them to excessive temperatures.
	Water pressure is low.	• Check the water pressure.
	The detergent in the main wash compartment got wet while taking in the prewash water. Holes of the detergent compartment are blocked.	• Check the holes and clean if they are clogged.
	There is a problem with the detergent drawer valves.	• Call the Authorised Service Agent.
	Detergent was mixed with the softener.	• Do not mix the softener with detergent. Wash and clean the drawer with hot water.
	Regular drum cleaning is not applied.	• Clean the drum regularly.
Too much foam forms inside the product. (**)	Improper detergents for the washing machine is used.	• Use detergents appropriate for the washing machine.
	Excessive amount of detergent is used.	• Use only sufficient amount of detergent.
	Detergent was stored under improper conditions.	• Store detergent in a closed and dry location. Do not store in excessively hot places.
	Some meshed laundry such as tulle may foam too much because of their texture.	• Use smaller amounts of detergent for this type of item.
	Detergent was put in the wrong compartment.	• Put the detergent in the correct compartment.
	Softener is being taken early by the product.	• There may be problem in the valves or in the detergent drawer. Call the Authorised Service Agent.
Foam is overflowing from the detergent drawer.	Too much detergent is used.	• Mix 1 tablespoonful softener and ½ l water and pour into the main wash compartment of the detergent drawer.
		• Put detergent into the product suitable for the programmes and maximum loads indicated in the "Programme table". When you use additional chemicals (stain removers, bleaches and etc), reduce the amount of detergent.

Problem	Cause	Solution
Laundry remains wet at the end of the programme. (*)	Excessive foam has occurred and automatic foam absorption system has been activated due to too much detergent usage.	<ul style="list-style-type: none"> • Use recommended amount of detergent.

(*) The product does not switch to spinning step when the laundry is not evenly distributed in the drum to prevent any damage to the product and to its surrounding environment. Laundry should be rearranged and re-spun.

(**) Regular drum cleaning is not applied. Clean the drum regularly.



CAUTION!

- If you cannot eliminate the problem although you follow the instructions in this section, consult the dealer or the Authorised Service Agent. Never try to repair a nonfunctional product yourself.



www.beko.com