



Built-in Electric Cooktop

User Manual

IMPORTANT

Installer should leave these instructions with appliance.

Consumer should read these instructions before using the appliance and should retain them for future reference.

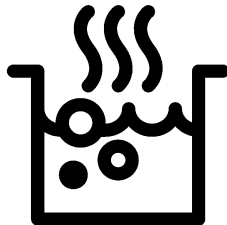

ECTM24102

EN

185.9275.83/R.AE/24.09.2020/3-1

7735687904

IMPORTANT SAFETY INSTRUCTIONS

READ AND SAVE THESE INSTRUCTIONS



WARNING: Read all safety instructions before using the product. If the information in this manual is not followed exactly, a fire or explosion may result causing property damage, personal injury or death.



IMPORTANT:

This appliance is intended for normal household use only. It is not approved for outdoor or other non-household uses (including sea or air-going vessels). See the Statement of Limited Warranty. If you have any questions, contact the manufacturer.

Do not repair or replace any part of the appliance unless specifically recommended in this manual. Refer all servicing to a factory authorized service center.

Explanation of symbols

Throughout this User Manual the following symbols are used:



Important information or useful hints about usage.



Warning for hazardous situations with regard to life and property.



Warning for electric shock.



Warning for risk of fire.



Warning for hot surfaces.

DANGER indicates a hazardous situation which, if not avoided, will result in death or serious injury.

WARNING indicates a hazardous situation which, if not avoided, could result in death or serious injury.

CAUTION indicates a hazardous situation which, if not avoided, could result in minor or moderate injury.

NOTICE is used to address practices not related to physical injury.

**⚠ Please read these instructions before installation
or using your appliance!**

Dear Customer,

We would like you to obtain best performance with your product that has been manufactured in modern facilities and passed through strict quality control procedures.

Therefore, we advise you to read through this user manual carefully before using your product and keep it for future reference. If you hand over the product to someone else, deliver the user manual as well.

The user manual will help you use the product in a fast and safe way.



IMPORTANT:

Save these instructions for the local electrical inspectors use.

The instructions will help you to operate the appliance quickly and safely.

- Upon delivery, please check that the appliance is not damaged. If you note any transport damage, please contact your point of sale immediately and do not connect and operate the appliance!
- Before you connect and start using the appliance, please read this manual and all enclosed documents. Please note in particular the safety instructions.
- Keep all documents so that you can refer to the information again later on.
Please keep your receipt for any repairs which may be required under warranty.
- When you pass on the appliance to another person, please provide all documents with it including original date of purchasing. (The warranty does not convey if the unit is sold).
- If you should decide not to use this appliance any longer (or decide to substitute an older model), before disposing of it, it is recommended that it be made inoperative in an appropriate manner in accordance to health and environmental protection regulations, ensuring in particular that all potentially hazardous parts be made harmless, especially in relation to children who could play with old appliances.

TABLE OF CONTENTS

1 Safety Instructions - Read before use

6

Basic safety instructions	6
Safety for children	10
Safety when working with electricity	11
Intended use.....	12
Disposal	12
Packaging material.....	12
Future transportation	12

2 Installation

14

Before installation	14
Product Dimensions	15

3 Preparation

21

Tips for saving energy	21
Initial use.....	21
First cleaning of the appliance.....	21

4 How to use the hob

22

General information about cooking	22
Using the burners/plates.....	23
Control panel	24

5 Maintenance and care

30

General information.....	30
Cleaning the burner/plate	30
Cleaning the control panel	30

6 General information

31

Overview.....	31
Technical specifications.....	31

7 Troubleshooting

32

8 BEKO US RESIDENTIAL PRODUCT

WARRANTY

33

1 Safety Instructions - Read before use



This section contains safety instructions that will help you avoid risk of injury and damage. All warranties will become void if you do not follow these instructions.

Basic safety instructions

- The manufacturer reserves its right to make changes in the technical specifications in order to improve the appliance quality without any prior notice. Figures included in this manual are for schematic purpose only and may not match exactly with your appliance. Values stated on the markings of the appliance or in other printed documents supplied with the appliance are obtained under laboratory conditions as per relevant standards. These values may vary according to the usage of the appliance and ambient conditions.
- This appliance is not intended for use by persons (including children) with reduced physical, sensory or mental capabilities, or lack of experience and knowledge, unless they have been given supervision or instruction concerning use of appliance by a person responsible for their safety.
- Children should be supervised to ensure that they do not play with the appliance.
-  **WARNING:** This appliance can be used by children aged from 8 years and above and persons with reduced physical, sensory or mental capabilities or lack of experience and knowledge if they have been given supervision or instruction concerning use of the appliance in a safe way and understand the hazards involved.
- Children shall not play with the appliance. Cleaning and user maintenance shall not be made by children without supervision.
- Proper installation - Be sure your appliance is properly installed and grounded by a qualified technician.
- If the supply cord damaged, it must be replaced by a special cord or assembly available from the manufacturer or its service agent or similarly qualified persons.
- User servicing - Do not repair or replace any part of the appliance unless specifically recommended in the manual. All other servicing should be referred to a qualified technician.



- User servicing - During installation, maintenance, cleaning and repair, the unit must always be completely separated from the power supply. For this purpose pull out the plug or turn it off from the mains switch.
- Wear proper apparel - loose-fitting or hanging garments should never be worn while using the appliance.
- Use proper pan size - this appliance is equipped with one or more surface units of different size. Select utensils having flat bottoms large enough to cover the surface unit heating element. The use of undersized utensils will expose a portion of the heating element to direct contact and may result in ignition of clothing. Proper relationship of utensil to burner will also improve efficiency.
- Never leave surface units unattended at high heat settings – boil over causes smoking and greasy spillovers that may ignite.
- Do not allow aluminum foil, plastic, paper or cloth to come in contact with a hot surface. Do not allow pans to boil dry.
- Glazed cooking utensils - only certain types of glass, glass/ceramic, ceramic, earthenware, or other glazed utensils are suitable for range-top service without breaking due to the sudden change in temperature.
-  **CAUTION:** Use only dry potholders- moist or damp potholders on hot surfaces may result in burns from steam. Do not let potholder touch hot heating elements. Do not use a towel or other bulky clothes.
- Do not heat unopened food containers. Pressure could build up and the container could burst, causing an injury.
- **Make Sure Reflector Pans or Drip Bowls Are in Place -** Absence of these pans or bowls during cooking may subject wiring or components underneath to damage.
- Ensure that no flammable materials are adjacent to the appliance as the sides become hot during use.
- The manufacturer declines all liability for injury to persons or damage to property caused by incorrect or improper use of the appliance.
- Check that all controls on the appliance are switched off after use.
- Do not heat closed food containers and glass jars.

Pressure that may build-up in the jar can cause it to burst.



-  **WARNING:** Food Poisoning Hazard: Do not let food sit in oven for more than 1 hour before or after cooking. Doing so can result in food poisoning or sickness.
-  **CAUTION:** If a wet sponge or cloth is used to wipe spills on a hot cooking area, be careful to avoid steam burn. Some cleaners can produce noxious fumes if applied to a hot surface. Utensil handles should be turned inward and not extend over adjacent surface units. To reduce the risk of burns, ignition of flammable materials, and spillage due to unintentional contact with the utensil, the handle of a utensil should be positioned so that it is turned inward, and does not extend over adjacent surface units.
- Do not cook on broken cook-top - if cook-top should break, cleaning solutions and spillovers may penetrate the broken cook-top and create a risk of electric shock. Contact a qualified technician immediately.
- **Clean cook-top with caution** - if a wet sponge or cloth is used to wipe spills on a hot cooking area, be careful to avoid steam burn.

Some cleaners can produce noxious fumes if applied to a hot surface.

- **"Do not touch surface units or areas near units** - Surface units may be hot even though they are dark in color. Areas near surface units may become hot enough to cause burns. Surface elements may be hot even though they are dark in color. During and after use, do not touch, or let clothing or other flammable materials contact surface units or areas near units until they have had sufficient time to cool. Among these areas are the cook-top and surfaces facing the cook-top."
- Never use when judgment or coordination is impaired by the use of alcohol and/or drugs.
- Do not operate the appliance if it is defective or shows any visible damage.
- Do not carry out any repairs or modifications on the appliance. However, you may remedy some malfunctions; see Trouble-shooting.
- Be careful when using alcoholic drinks in your dishes. Alcohol evaporates in high temperatures and may cause fire since it will catch fire when it gets in contact with hot surfaces.

-  **WARNING:** Keep appliance area clear and free from combustible materials, gasoline, and other flammable vapors.
- **Do not use water on grease fires.** Smother fire or flame or use dry chemical or foam type extinguisher.
- Flaming grease outside of utensil can be extinguished with baking soda or, if available, a multipurpose dry chemical or foam type extinguisher.
- Grease is flammable and should be handled carefully.
- Vapour pressure that build up due to the moisture on the hob surface or at the bottom of the pot can cause the pot to move. Therefore, make sure that the oven surface and bottom of the pots are always dry.
- Only authorized replacement parts may be used in performing service on the range. Replacement parts are available from factory authorized parts distributors. Contact the nearest parts distributor in your area.
- Do not leave empty pots or pans on plates that are switched on. They might get damaged.
- Never pick up a flaming pan. Smother sheet or flat tray.
- Let fat cool before attempting to handle it.
- Wipe up spill over immediately.
- If you are "flaming" liquors or other spirits under an exhaust, **turn the fan off.** The draft could cause the flames to spread out of control.
- Never leave the surface area unattended at high heat setting. Boil over cause smoking and greasy spill over, which may ignite.
- Since it may be hot, do not leave plastic or aluminum dishes on the surface of appliance. These kind of dishes should not be used to keep food either.
-  **Danger of fire!** Do not store items on the cooking surfaces. Unattended cooking on a hob with fat or oil can be dangerous and may result in fire. NEVER try to extinguish a fire with water, but switch off the appliance and then cover flame e.g. with a lid or a fire blanket.
- To minimize the possibility of burns, ignition of flammable materials and spillage, the handle of a container should be turned toward the center of the cooktop without extending over any nearby surface units.
- Use only certain types of glass, heatproof glass ceramic, ceramic,

earthenware, or other glazed utensils that are suitable for cooktop use.

- Do not place any flammable materials close to the product as the sides may become hot during use.
- **Be careful to prevent burns.** If the flames do not go out immediately, **evacuate and call the fire department.**
- Always have a working smoke detector near the kitchen.
- Leave the hood ventilator on when flambéing food **only if there is smoke without flames.**
-  **WARNING:** Use this appliance for its intended purpose as described in this owner's manual.
-  **IMPORTANT:** Call the authorized service for installation of the appliance to be used. After this procedure, guarantee period will be started.

Use an extinguisher only if



- Always have a working smoke detector near the kitchen.
- You know you have a Class ABC extinguisher, and you already know how to operate it.
- The fire is small and contained in the area where it started.
- The fire department is being called.

- You can fight the fire with your back to an exit.
- **Never** use water on cooking fires.
- In the event that personal clothing catches fire, **drop and roll immediately** to extinguish flames.

Safety for children

- Surface units may be hot even though they are dark in color. Areas near surface units may become hot enough to cause burns. During and after use, do not touch or let clothing or other flammable materials contact surface units until they have had sufficient time to cool. Among these areas are (identification of areas) for example, the cook-top and surfaces facing the cook-top.
- The packaging materials will be dangerous for children. Keep the packaging materials away from children. Please dispose of all parts of the packaging according to environmental standards.
- Do not leave children or pets alone - children should not be left alone or unattended in area where appliance is in use. They should never be allowed to sit or stand on any part of the appliance.
- Do not place any items above the appliance that children may reach for.

Safety when working with electricity

- Only connect the product to a grounded outlet/line with the voltage and protection as specified in the “Technical specifications”. Have the grounding installation made by a qualified electrician while using the product with or without a transformer. Our company shall not be liable for any problems arising due to the product not being earthed in accordance with the local regulations.
-  **WARNING:** Only use the connection cable specified in the “Technical specifications”. If the supply cord damaged, it must be replaced by a special cord or assembly available from the manufacturer or its service agent or similarly qualified persons in order to avoid a hazard.
- The appliance must be installed so that it can be completely disconnected from the network. The separation must be provided either by a mains plug, or a switch built into the fixed electrical installation, according to construction regulations.
-  **WARNING:** Before installing, turn power OFF at the service panel. Lock service panel to prevent power from being turned ON accidentally.
-  **WARNING:** Personal injury or death from electrical shock may occur if the product is not installed by a qualified installer or electrician.
- Never wash down the product with water! There is the risk of electric shock!
- Any additions, changes or conversions required in order for this appliance to satisfactorily meet the application needs must be made by a qualified technician.
- Before performing any service, unplug the product or disconnect the power supply at the household distribution panel by removing the fuse or switching off the circuit breaker.
- Any work on electric equipment and systems may only be carried out by authorized qualified persons.
- In case of any damage, switch off the appliance and disconnect it from the main supply by removing the fuse or switching off the circuit breaker.
- Ensure that the fuse rating is correct.
- Do not operate the appliance barefooted.
- Never touch the appliance with wet hands or feet.

- Do not use steam cleaners to clean the appliance as this may cause an electric shock.
-  **Electric shock!** If the surface is cracked, switch off the appliance to avoid the possibility of electric shock.

Intended use

-  **WARNING:** Never use your appliance for warming or heating the room.
- This product is designed for domestic cooking purposes only. It is not designed for any other uses such as room heating or drying towels and dish cloths. Commercial use will void the guarantee.
- This appliance is not intended to use at mobile homes, recreational vehicles.
- The manufacturer shall not be held liable for any damage caused by improper use or handling errors.
- Service life of your product is 10 years. Manufacturer shall provide the required spare parts for the product to perform as defined during this period.

Disposal

Packaging material



DANGER:

Risk of suffocation by the packaging materials!

Packing elements (i.e. plastic bags, polystyrene foam, nails, packing straps, etc.) should not be left around within easy reach of children, as these may cause serious injuries.

The packaging material and transport locks are made from materials that are not harmful to the environment. Please dispose of all parts of the packaging according to environmental standards. This is beneficial to the environment.



CAUTION:

If product will be given to someone for personal use or given to someone for second hand use, User manual, product labels, other related documents, mounting parts etc. should be given with product.

Electrical connection should be done according to User Manual.

Future transportation

Do not carry out cleaning or maintenance operations on the appliance without having previously disconnected it from the electric power supply.



NOTICE:

Do not place other items on the top of the appliance. The appliance must be transported upright.

Store the appliance's original box and transport the appliance in its original carton. Follow the guidance marks that are printed on the carton.



IMPORTANT:

Verify the general appearance of your equipment by identifying possible damage during the transportation.

To prevent the wire shelf and tray inside the oven from damaging the oven door, place a strip of cardboard onto the inside of the oven door that lines up with the position of the trays. Tape the oven door to the side walls.

If you do not have the original carton

Pack the appliance in bubble wrap or thick cardboard and tape it securely in order to prevent damage during transportation.



WARNING: This product can expose you to chemicals including Nickel (Metallic) which is known to the State of California to cause cancer. For more information go to www.P65Warnings.ca.gov

Note: Nickel is a component in all stainless steel and some other metal components.

2 Installation



IMPORTANT

Save for the local electrical inspector's use.



IMPORTANT:

The product should only be installed by suitably qualified electricians.

- Preparation of location and electrical installation for the product is under customer's responsibility.
- The product must be installed in accordance with all local electrical regulations.
- Prior to installation, visually check if the product has any defects on it. If so, do not have it installed.
- Damaged products cause risks for your safety.
- Product guarantee will be valid after proper installation. Manufacturer will not be responsible any hazard or damage of improper installation or usage.

Before installation

The hob is designed for installation in a commercial worktop. A safety distance must be left between the appliance and the kitchen walls and furniture. See figure (values in mm).

- The following installation drawings are representational and may not match exactly with your appliance
- Allow a minimum distance of 750 mm above the hob surface.
- (*) If a cooker hood is to be installed above the cooker, refer to cooker hood manufacturer' instructions regarding installation height (min 650 mm)
- Remove packaging materials and transport locks.
- Surfaces, synthetic laminates and adhesives used must be heat resistant (100 °C minimum).
- The worktop must be aligned and fixed horizontally.

- Cut aperture for the hob in worktop as per installation dimensions.
- Write down the model and serial numbers before installing the cooktop. Both numbers are on the box. Serial rating plate located on bottom of cooktop box.
- To eliminate the risk of burns by reaching over heated surface units, cabinet storage space located above the surface units should be avoided. If the cabinet storage is to be provided, the risk can be reduced by installing a range hood that projects horizontally a minimum of 5" (12,7 cm) beyond the bottom of cabinet.



IMPORTANT

Do not install the appliance next to refrigerators or freezers. The heat emitted by the appliance will lead to an increased energy consumption of cooling appliances.



Important notes to the consumer

Keep this manual for future reference.

- If the information in this manual is not followed exactly, a fire or explosion may result in personal injury or death.
- Do not store or use gasoline or other flammable vapors and liquids in the vicinity of this or any other appliance.

You can be killed or seriously injured if you don't IMMEDIATELY follow instructions.



Important notes to the installer

Read manual before installing the cook top. Observe all governing codes and ordinances. Be sure to leave these instructions with the consumer.

Be sure your cook top is installed and grounded properly by a qualified installer or service technician.

Product Dimensions

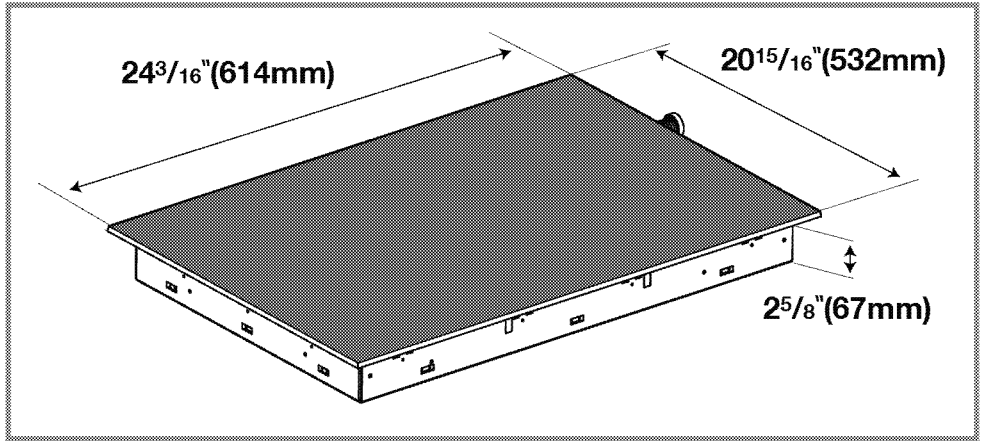

Cutout Dimensions

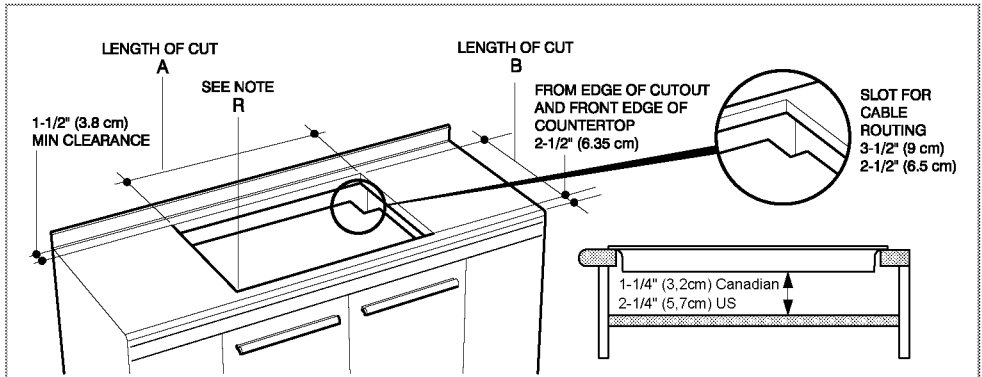

Cutout Requirements

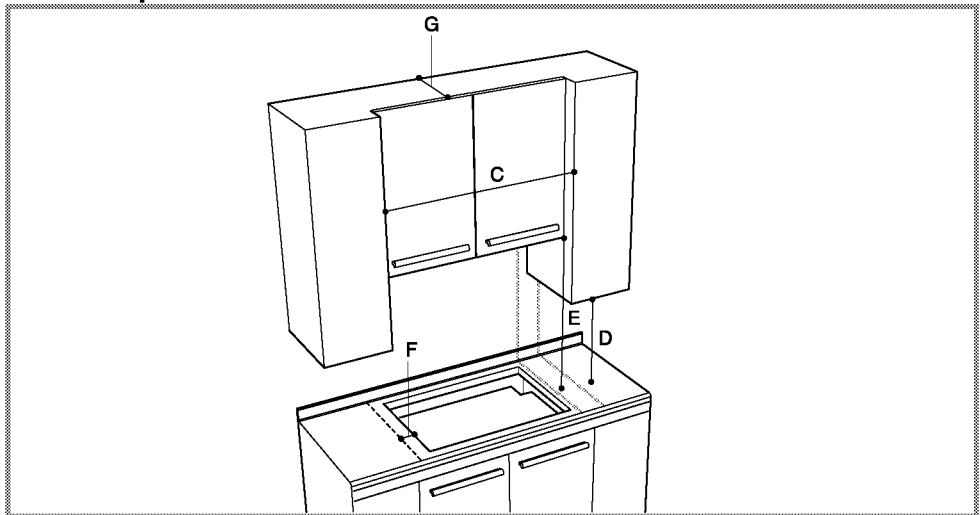

CUTOUT WIDTH	A	B	C	D	E	F	G
24" (614 mm)	22-13/16" (580 mm)	19-5/8" (498 mm)	24" (614 mm)	18" (457 mm) min Height from countertop to nearest cabinet on either side of unit	30" (762 mm) min. (see note*) Clearance from countertop to unprotect overhead surface	2" (50 mm) min Clearance from cutout to side wall on the left and right of the unit	13" (330 mm) Depth of unprotect overhead cabinets
IMPORTANT: Under the cooktop it is necessary to install a partition, spaced at least 15 mm. from the bottom of the appliance as shown in figure 3.			*NOTE: 24" (610 mm) min. clearance if bottom of wood or metal cabinets is protected by not less than 1/4" (0.6 cm) flame retardant mill-board covered with no less than No. 28 MSG sheet steel 0.015" (0.04 cm) stainless steel, or 0.024" (0.06 cm) aluminum or 0.020" (0.05cm) copper. 30"(762 mm) min. clearance between top of cooking platform and bottom of unprotect wood or metal cabinet				

Important Preparation Suggestions

1. Chamfer all exposed edges of decorative laminate to prevent damage from chipping.
2. Radius corners of cutout and file to insure smooth edges and prevent corner cracking. Recommend 1/4" or 3/8" diameter drill in each corner.
3. Rough edges, inside corners which have not been rounded and forced fits can contribute to cracking of the countertop laminate.

This cooktop has been designed with wide tolerances of cut-out to cover possible replacement with other brands. We recommend to that you consider the minimum dimension of cutout size in the case of new installation. Some cut out sizes for possible replacements

Dimension	inches	mm
24"	22-13/16" x 19-5/8"	498x580

Cooktop Installation



Excessive Weight Hazard

Use two or more people to move and install cooktop. Failure to do so can result in back or other injury.



Cut Hazard

Beware of sharp edges. Use the polystyrene ends when carrying the product. Failure to use caution could result in minor injury or cuts.

- Always consult the countertop manufacturer for specific instructions.
- Ensure the countertop is square and level and ensure no structural members interfere with space requirements.
- Prepare the cut-out according to the instructions (see cut-out dimensions).
- Make sure the wall coverings, countertop and cabinets around the cooktop can withstand heat (up to 212 °F / 100 °C).
- During installation of your induction hob, place the product parallel to the installation surface. Also, apply sealing gasket to the parts of the hob contacting the counter as described below in order to prevent any liquid from penetrating between the product and the counter.

1. Prepare the surface of the counter as shown in the figure.
2. Turning the hob upside down, place it on a flat surface.
3. The sealing gasket provided in the package must be applied on the lower casing bend around the hob as shown in the figure, during installation of the hob.

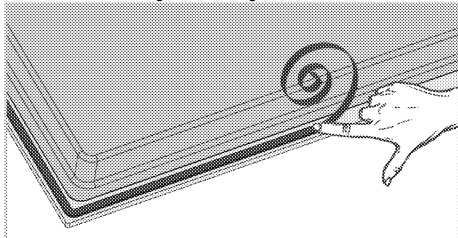

4. Insert the cooktop centered into the cutout opening. Make sure the front edge of the counter top is parallel to the cooktop. Make final check that all required clearances are met.

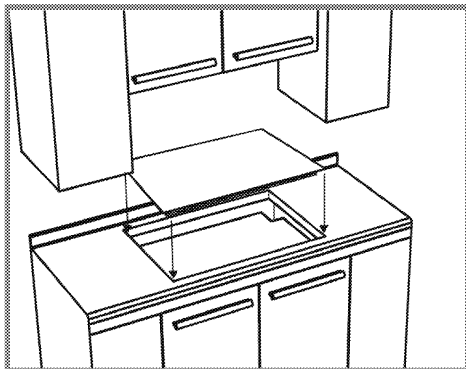

5. Clamp brackets are provided to clamp the cooktop to the countertop. Tighten screws just enough to hold brackets in place when cooktop is put into cutout. Tighten screws securely. Connect it to the holes in the lower housing as indicated in the figure.

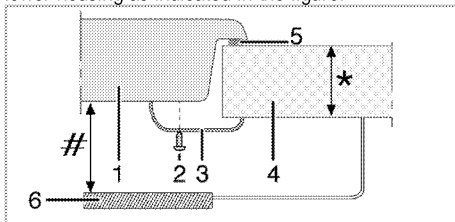

- * min. 20 & max. 40 mm
- # min. 50 mm
- 1 Hob
- 2 Screw
- 3 Fixing clamp
- 4 Worktop
- 5 Sealing gasket
- 6 Dividing shelf



When installing the hob onto a cabinet, a shelf must be installed in order to separate the cabinet from the hob as illustrated in the above figure. This is not required when installing onto a built-under oven.

For example, if it is possible to touch the bottom of the product since it is installed onto a drawer, this section must be covered with a wooden plate.

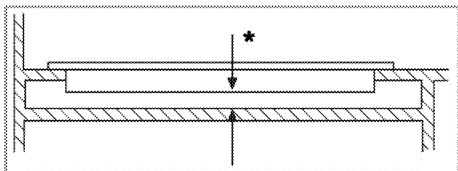

* min. 15 mm

Bottom view (clamp holes)

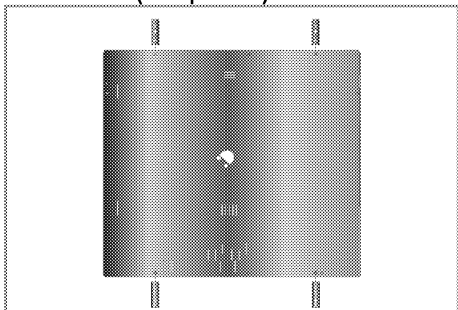

DANGER:

Making connections to different holes is not a good practice in terms of safety since it can damage the gas and electrical system.



DANGER:

There are gas/electric components on hobs. Therefore stove, only the connection hole shown in this manual should only be fixed to the unit as shown in the manual using the supplied fasteners and screws supplied. Otherwise, it is dangerous to the life and property safety.

Connection to the mains supply



This appliance must be earthed! Our company shall not be held responsible for any damage caused by using the appliance without an earthed socket. This appliance must be electrically grounded in accordance with local codes, or in their absence, with the National Electrical Code ANSI/NFPA No. 70-latest edition in United States.



Disconnect power before servicing the product. Failure to do so could result in death or electrical shock.



DANGER

The product must be connected to the mains supply only by an authorised and qualified person. The product's warranty period starts only after correct installation.

Manufacturer shall not be held responsible for damages arising from procedures carried out by unauthorised persons.



DANGER

The power cable must not be clamped, bent or trapped or come into contact with hot parts of the product.

A damaged power cable must be replaced by a qualified electrician. Otherwise, there is risk of electric shock, short circuit or fire!

- The mains supply data must correspond to the data specified on the rating plate of the appliance. The rating plate is located at the rear housing of the appliance.
- The appliance mains cable must correspond to the specifications and the power consumption; see *Technical specifications, page 31*.



DANGER:

Before starting any work on the electrical installation, disconnect the product from the mains supply. There is the risk of electric shock!

This cooktop does not require a neutral connection. If the cooktop is to be completely enclosed in a cabinet, feed the cooktop cable through the opening in the cabinet. Make the electrical connection following the appropriate steps for your installation. Your cooktop must be connected to the proper electrical voltage and frequency as specified in the table on the right.

Connect with copper wire only

If house has aluminum wiring, follow the procedure below:

1. Connect the aluminum wiring to the copper wire by using special connectors designed and Underwriters Laboratories-listed for joining copper to aluminum. Follow the electrical connector manufacturer's recommended procedure.

2. Aluminum/copper connection must conform with local codes and industry- accepted wiring practices.

The flexible conduit (supplied) min. 4 feet long (120 cm) located at the right rear of the cooktop bottom box should be connected directly to junction box. Do not cut the conduit. A U.L. - or CSA - listed conduit connector must be provided at each end of the power supply cable (at the cooktop and at the junction box.) A time delay fuse or circuit breaker is recommended. Do not ground to a gas pipe. Do not have a fuse in the grounding or neutral circuit. Fuse both supply (phase) lines.



Improper connection of aluminum house wiring to the copper leads can result in a serious problem.

National Fire Protection Association Batter/march Park Quincy, Massachusetts 02269

A three-wire, single phase, 240 Volt 60 cycle electrical system (properly circuit protected to meet Local Codes of NFPA No.70) must be provided. Unit must be properly grounded in accordance with local wiring code. The chart below recommends the minimum circuit protector and wire size if the appliance is the only unit on the circuit. If smaller sizes of wire are used, the unit efficiency will be reduced and a fire hazard may be created. It is advisable that the electrical wiring and hookup be accomplished by a competent electrician.

Be sure your appliance is properly installed and grounded by a qualified technician. Ask your dealer to recommend a qualified technician or an authorized repair service. This cooktop does not require a neutral connection. If the cooktop is to be completely enclosed in a cabinet, feed the cooktop cable through the opening in the cabinet. Make the electrical connection following the appropriate steps for your installation.



DANGER
Risk of Electric Shock, frame grounded to neutral of appliance through a link.

Grounding through the neutral conductor is prohibited for new branch-circuit installations (1996 NEC)# mobile homes#and recreational vehicles, or in an area where local codes prohibit grounding through the neutral conductor.

3-Wire branch circuit (for US only)

Where local codes allow the connection of ground wire from the cooktop to the branch circuit neutral wire (gray or white colored wire) proceed as follows (see figure 13).

- If local codes permit, connect the green GROUND wire from the oven and white wire from the cooktop to the branch circuit NEUTRAL wire (gray or white colored wire).
- Connect the red and black leads from the oven to the corresponding leads in the junction box.

Figure 13.

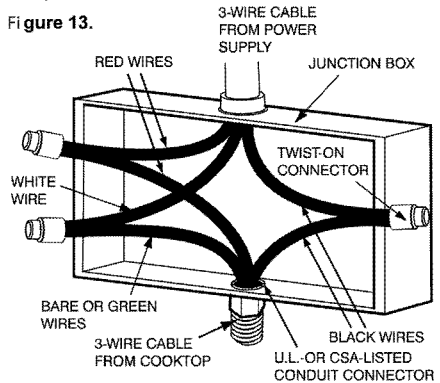

Where local codes permit connecting the frame-ground conductor to the neutral (white) junction box wire. (Not used for Canadian installations)

INST 031-2

4 - Wire branch circuit (for US and Canada)

Refer to figure 14:

- Connect the green ground wire from the cook-top to the ground wire in the junction box (bare or green colored wire).
- Connect the red and black leads from the cooktop to the corresponding leads in the junction box.
- Connect the white wire from the cooktop to the neutral (gray or white) wire in the junction box.
- Terminate and insulate the neutral (gray or white colored wire) in the junction box.

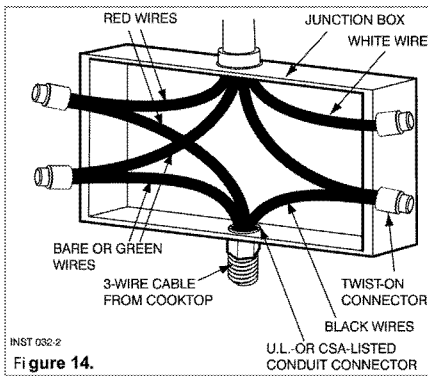

Final check

1. Connect the appliance to the mains supply and switch on the mains supply.
2. Check function.

3 Preparation

Tips for saving energy

The following information will help you to use your appliance in an ecological way, and to save energy:

- Defrost frozen dishes before cooking them.
- Use pots/pans with cover for cooking. If there is no cover, energy consumption may increase 4 times.
- Select the burner which is suitable for the bottom size of the pot to be used. Always select the correct pot size for your dishes. Larger pots require more energy.
- Pay attention to use flat bottom pots when cooking with electric hobs. Pots with thick bottom will provide a better heat conduction. You can obtain energy savings up to 1/3.
- Vessels and pots must be compatible with the cooking zones. Bottom of the vessels or pots must not be smaller than the hotplate.
- Keep the cooking zones and bottom of the pots clean. Dirt will decrease the heat

conduction between the cooking zone and bottom of the pot.

- For long cookings, turn off the cooking zone 5 or 10 minutes before the end of cooking time. You can obtain energy savings up to 20% by using the residual heat.

Initial use

First cleaning of the appliance



The surface might get damaged by some detergents or cleaning materials.

Do not use aggressive detergents, cleaning powders/creams or any sharp objects during cleaning.

Do not use harsh abrasive cleaners or sharp metal scrapers to clean the oven door glass since they can scratch the surface, which may result in shattering of the glass.

1. Remove all packaging materials.
2. Wipe the surfaces of the appliance with a damp cloth or sponge and dry with a cloth.

4 How to use the hob

General information about cooking



DANGER

Risk of fire over by overheated oil!

When you heat oil, do not leave it unattended.



WARNING

Never try to extinguish the fire with water!

When oil has caught fire, immediately cover the pot or pan with a lid. Switch off the burner/plate if safe to do so and phone the fire service.

- Only use flat bottomed pots or pans.
- Use pans which have sufficient capacity for the amount of food being cooked so they don't boil over and cause unnecessary cleaning.
- Do not place lids on the burners.
- Always position pans centrally over the burners. When transferring pans from one burner to another always lift the pans do not slide them.
- This appliance is equipped with one or more surface units of different size. Select utensils having flat bottoms large enough to cover the surface unit heating element. The use of undersized utensils will expose a portion of the heating element to direct contact and may result in ignition of clothing. Proper relationship of utensil to heating element will also improve efficiency.
- Never leave surface units unattended at high heat settings. Boilover causes smoking and greasy spillovers that may ignite.
- Make sure reflector pans or drip bowls are in place. Absence of these pans or bowls during cooking may subject wiring or components underneath to damage.



WARNING

Never leave surface units unattended at high heat settings. Boil over causes smoking and greasy spillovers that may ignite.

- Make sure reflector pans or drip bowls are in place. Absence of these pans or bowls during cooking may subject wiring or components underneath to damage.

Tips for glass ceramic plate

- The glass ceramic surface is heat-resistant and insensitive to large temperature deviations.
- Do not use the glass ceramic plate for keeping objects or as cutting surface.



WARNING

Do not cook popcorn in prepackaged aluminum containers on the cook top. They could leave aluminum marks that cannot be removed completely.

- Use pot and pans with ground bottoms. Sharp edges cause scratches on the surface.
- Do not use aluminum pots and pans. Aluminum damages the glass ceramic surface.



WARNING

Glazed cooking utensils - only certain types of glass, glass/ceramic, ceramic, earthenware, or other glazed utensils are suitable for range-top service without breaking due to the sudden change in temperature.

- Do not cook foods directly on the cook-top.
- For foods containing sugar in any form, clean up all spills and soils as soon as possible. Allow the cook-top to cool down slightly. Then, while wearing oven mitts, remove the spills while the surface is still warm. If sugary spills are allowed to cool down, they can adhere to the cook-top and can cause pitting and permanent marks.



WARNING

Use pot and pans with ground bottoms. Sharp edges cause scratches on the surface.



WARNING

Avoid scratching the glass cook top. The cook top can be scratched with items such as knives, sharp instruments, rings or other jewelry and rivets on clothing.



WARNING

If a wet sponge or cloth is used to wipe spills on a hot cooking area, be careful to avoid steam burn. Some cleaners can produce noxious fumes if applied to a hot surface. Utensil handles should be turned inward and not extend over adjacent Face units. To reduce the risk of burns, ignition of flammable materials, and spillage due to unintentional contact with the utensil, the handle of a utensil should be positioned so that it is turned inward, and does not extend over adjacent surface units.

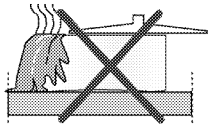

Splashes may damage the ceramic surface and can cause fire.

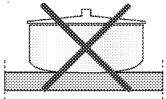

Do not use pots that have concave or convex bottoms.

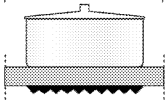

Use pot and pans with smooth bottoms. They ensure a good heat transfer.

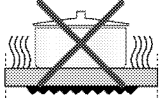

If the pan is too small energy is wasted



DANGER

Tippling of pan

Make sure that the handles of cookware do not stick out over the edge of the appliance, to avoid them being knocked over by accident. This also makes it more difficult for children to reach the cooking pans.

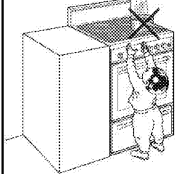

- Ensure handles of pans cannot accidentally be caught or knocked and do not get hot by adjacent heating zones. Avoid pans that are unstable and easily

tipped. Pans that are too heavy to move easily when filled can also be a hazard.



WARNING

Do not store items of interest to children in cabinets above a range or on the back guard of a range – children climbing on the range to reach items could be seriously injured.

Using the burners/plates

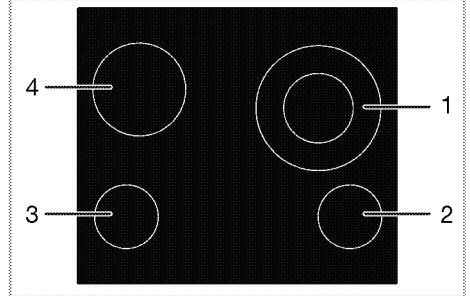

- 1 Dual-circuit cooking plate 4,5-5,5 / 8-9 inches (120-140 / 210-230 mm)
- 2 Single-circuit cooking plate 4-4,5 inches (100-120 mm)
- 3 Single-circuit cooking plate 4-4,5 inches (100-120 mm)
- 4 Single-circuit cooking plate 5,5- 6,3 inches (140-160 mm) inches is list of advised diameter of pots to be used on related burners.



DANGER:

Avoid scratching or impacting glass doors, cook tops or control panels. Doing so may lead to glass breakage. Do not cook on a product with broken glass. Shock, fire or cuts may occur.

Do not let any objects fall onto the plate. Even small objects (e.g. salt shaker) may damage the burner/ plate.



DANGER:

Do not use glass ceramic plates with cracks. Water may enter into the cracks and cause a short circuit.



DANGER:

If the surface is damaged in any way (e. g. visible cracks), switch off the device immediately to reduce the risk of an electric shock. If cooktop should break, cleaning solutions and spillovers may penetrate the broken cook-top and create a risk of electric shock. Contact a qualified technician immediately.



WARNING

The glass ceramic burner/plate is equipped with an operating lamp and a residual heat indicator.

The residual heat indicator indicates the position of the switched on plate and remains illuminated after switching off. (When the temperature of the plate falls below touchable temperature the indicator light will go off).



NOTICE:

Quick heating glass-ceramic plates emit a bright light when they are switched on. Do not stare to bright light.

Control panel

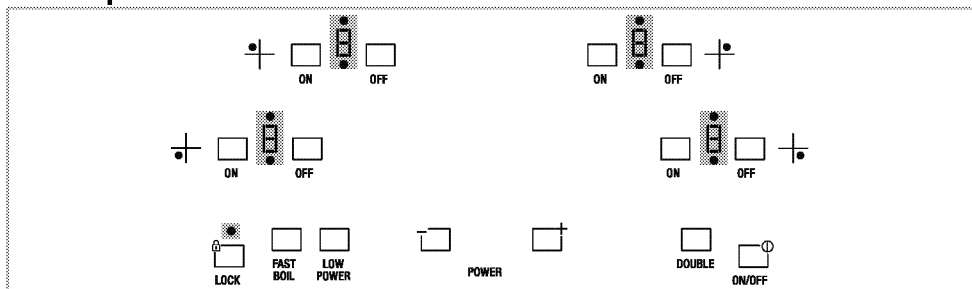

Specifications

On / Off key

Keylock key

Double cooking zone key

Fast boil key

Low power key

Minus key

Plus key

Cooking Zone display

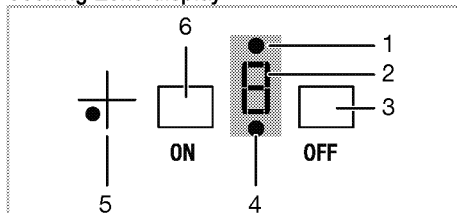

1 Upper warning light

2 Temperature level

3 Cooking zone off key

4 Lower warning light

5 Cooking zone symbol

6 Cooking zone on key



Graphics and figures are for informational purposes only. Actual appearances or functions may vary according to the model of your hob.

i This product is controlled by means of a touch control panel. Each operation you make on your touch control panel will be confirmed by an audible signal.

i Always keep the control panel clean and dry. Having damp and soiled surface may cause problems in the functions.

i If you touch two or more keys on the control panel simultaneously, the product will turn off in ten seconds. You will hear a signal tone every 10 seconds if you keep touching.

Turning on the cooktop

The key lock will be active when the cooktop is energised for the first time.

1. Touch "LOCK" key for about 2 seconds to cancel the key lock.

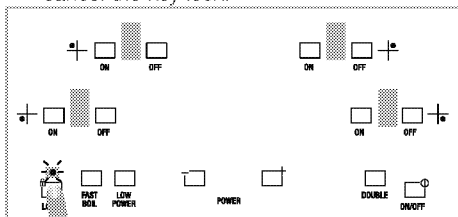

2. Turn on the cooktop by touching the "ON/OFF" key for about 2 seconds.
» "0" will appear on all cooking zone displays. Cooking zone is ready for use.

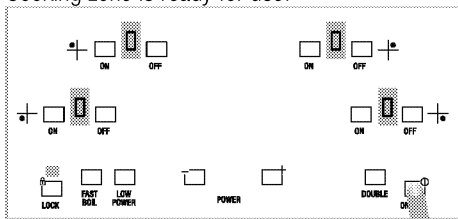

i The hob will automatically return to Standby mode if no operation is performed within 10 seconds.

Switching off the cooktop:

1. Turn off the cooktop by touching the "ON/OFF" key for about 2 seconds.
» All active cooking zones will turn off simultaneously.

i If the lower warning light is active on the cooking zone display after the cooking zones have been turned off, the cooking zone is still hot. Do not touch the cooking zones in such a case. The cooking zones may be hot even if the lower warning light has gone off. Do not touch the cooking zones until they are cold.

Operating the cooking zones

1. After turning on the cooktop, touch the "ON" key of the desired cooking zone for about 2 seconds.

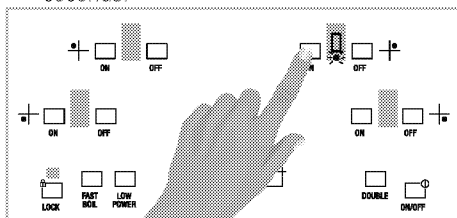

» Lower warning light will start to flash on the display of the relevant cooking zone.

2. Touch "0" power keys to set the desired temperature level for the cooking zone.

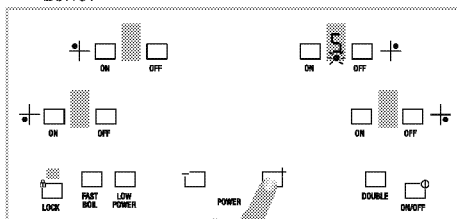

» The temperature level will be confirmed in 10 seconds and the lower warning light will become on. The relevant cooking zone will start to operate at the set temperature level. If you touch "ON" key of another cooking zone before ten seconds, the setting will be confirmed immediately.

You can operate other cooking zones as well by following the same steps and setting the temperature levels.

i If the lower light of a cooking zone is on, you cannot perform any setting for that cooking zone. To be able to perform setting, you need to touch "ON" key of that cooking zone and the lower warning light must be flashing.

Operating multiple cooking zones

1. After turning on the cooktop, touch the "ON" key of the desired dual cooking zone for about 2 seconds.

» Lower warning light will start to flash on the display of the relevant cooking zone.

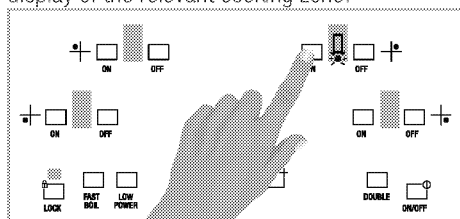

2. Touch "DOUBLE" key to activate the outer section as well.

» The upper warning light on the display of the relevant cooking zone will become on and the lower warning light will keep flashing.

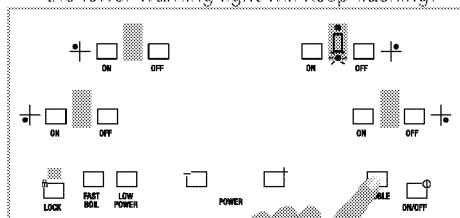

3. Touch "—" / "+" power keys to set the desired temperature level for the cooking zone.

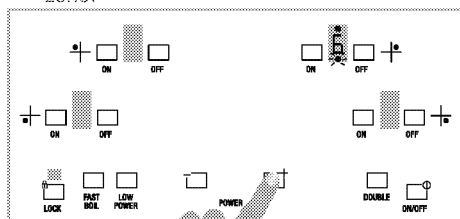

» The temperature level will be confirmed in 10 seconds and the lower warning light will become on. Both inner and outer sections of the selected cooking zone will become active simultaneously at the set temperature. If you touch "ON" key of

another cooking zone before ten seconds, the setting will be confirmed immediately.

4. If you want to operate only the inner section of the active cooking zone, touch "ON" key of the relevant multiple zone to activate the cooking zone. The lower warning light will start to flash. Disable the outer section by touching "DOUBLE" key.

» The upper warning light will go off and the lower warning light will keep flashing. The setting will be confirmed in 10 seconds and the lower warning light will become on. The outer section will stop operating and only the inner section will stay active.

If you touch "ON" key of another cooking zone before ten seconds, the setting will be confirmed immediately.

i The outer section of the cooking zone cannot be activated without the inner section.

Switching off the cooking zone:

An active cooking zone can be switched off in 2 different ways:

1. **By touching the "OFF" key of the relevant cooking zone;**

Touch the "OFF" key of the cooking zone you want to switch off.

2. **By dropping the temperature to "0" level;**
You can switch off the cooking zone by adjusting the temperature setting to "0" level.

i If the lower warning light is active on the cooking zone display after the cooking zones have been turned off, the cooking zone is still hot. Do not touch the cooking zones in such a case. The cooking zones may be hot even if the lower warning light has gone off. Do not touch the cooking zones until they are cold.

Residual heat indicator

If the lower warning light is active on the cooking zone display after the cooking zones have been turned off, the cooking zone is still hot. Do not touch the cooking zones in such a case. The cooking zones may be hot even if the lower

warning light has gone off. Do not touch the cooking zones until they are cold.



When the electricity is cut off, lower warning light will not light up and does not warn the user against hot cooking zones.

Fast Boil setting

You can use fast boil function for rapid heating. However, this function is not recommended for cooking a long time.

Selecting the fast boil setting (BOOSTER):

1. After turning on the cooktop, touch the "ON" key of the desired cooking zone for about 2 seconds.

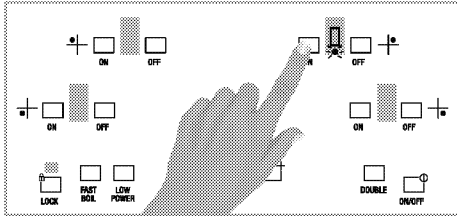

» Lower warning light will start to flash on the display of the relevant cooking zone.

2. Touch "—" / "+" power keys to set the desired temperature level for the cooking zone.

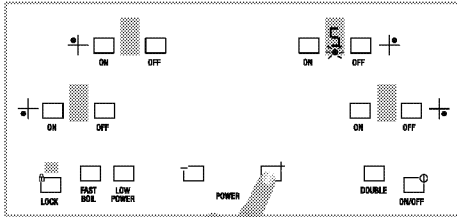

3. While the lower warning light is flashing, touch "FAST BOIL." key.

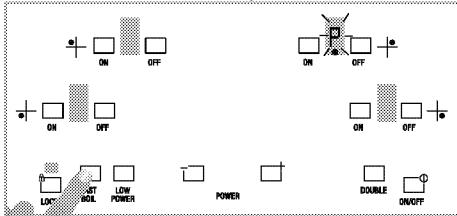

» The setting will be confirmed in 10 seconds and the lower warning light will become on. The selected cooking zone will operate at the highest temperature level for ten minutes. The set tem-

perature level and "P" will appear respectively on the display of the cooking zone.

After 10 minutes, the relevant cooking zone will continue to operate at the set temperature level, and this level will appear on the display.



If the lower light of a cooking zone is on, you cannot perform any setting for that cooking zone. To be able to perform setting, you need to touch "ON" key of that cooking zone and the lower warning light must be flashing.

Low Power setting

You can use this function to keep your meal warm after the cooking process is completed.

Selecting the low power setting:

1. Once you have completed the cooking process with a cooking zone at a temperature level, touch the "ON" key of the relevant cooking zone for about 2 seconds.

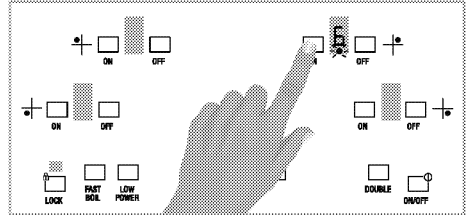

» Lower warning light will flash on the display of the relevant cooking zone.

2. While the lower warning light is flashing, touch "LOW POWER" key.

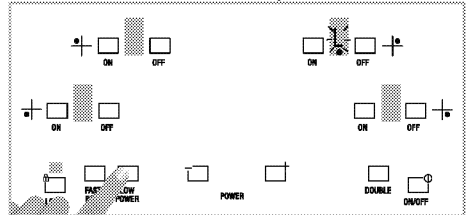

» The setting will be confirmed in 10 seconds and the lower warning light will become on. The set temperature level and "L" will appear respectively on the display of the relevant cooking zone. The cooking zone will continue to operate for a shortened period of time.

Please see the table below for normal operating duration percentages and shortened operating duration percentages.

Table-1: Normal operating duration percentages

Temperature level	Power supply	
	240 V	208 V
0	0%	0%
1	3%	3.4%
2	7%	8%
3	11%	12.6%
4	18.5%	21.2%
5	26%	29.9%
6	36%	41.4%
7	46%	52.9%
8	65%	74.7%
9	100%	100%

Table-2: Shortened operating duration percentages (Low Power)

Temperature level	Power supply	
	240 V	208 V
0	0%	0%
1	2%	2,3%
2	2.5%	2.8%
3	3%	3.4%
4	3,5%	4%
5	4%	4,6%
6	6%	6,9%
7	8%	9,2%
8	10%	11,5%
9	14%	16,1%

Activating the key lock

1. When the hob is in the on or off position, touch the "LOCK" key for about 2 seconds to activate the key lock.



If you activate the key lock when the hob is on, the hob can be turned off; however, once it has been turned off while the key lock is active, it cannot be turned on again. You must deactivate the key lock to turn it on again.

» "LOCK" warning light will be active on the display.

Deactivating the key lock

1. Touch the "LOCK" key for about 2 seconds to cancel the key lock.

Operation time limits

The cooktop control is equipped with an operation time limit. When one or more cooking zones

are left on, the cooking zone will automatically be deactivated after a certain period of time (see Table-3). If there is a timer assigned to the cooking zone, the timer display will also turn off later. Operation time limit depends on the selected temperature level. Maximum operation time is applied at this temperature level.

The cooking zone may be restarted by the user after it is turned off automatically as described above.

Table-3: Operation time limits

Temperature level	Operation time limit - hour
0	0
1	10
2	10
3	10
4	10
5	10
6	10
7	10
8	10
9	3
Rapid Heating	10 minutes

Overheating protection

Your cooktop is equipped with some sensors ensuring protection against overheating. Following may be observed in case of overheating:



- Active cooking zone may be turned off.
- Selected level may drop. However, this condition cannot be seen on the indicator.

Error messages

Table-4: Error codes and error causes

Error cause	Indicator	Display
"ON/OFF" key sender sensor error	"FA" symbol lights up	All cooking zone displays
"ON/OFF" key receiver sensor error	"FC" symbol lights up	All cooking zone displays
NTC short circuit	"FE" symbol lights up	All cooking zone displays
NTC open circuit	"Ft" symbol lights up	All cooking zone displays
High temperature error	"Fc" symbol lights up	All cooking zone displays

Relay error	"Fr" symbol lights up	All cooking zone displays
Eeprom Checksum error	"FH" symbol lights up	All cooking zone displays
ADC error	"FJ" symbol lights up	All cooking zone displays
Software error	"FO" symbol lights up	All cooking zone displays
Ambient light error	"FL" symbol lights up	All cooking zone displays
"ON/OFF" key LED error	"Fd" symbol lights up	All cooking zone displays

	For further information about error messages that may appear on the touch control panel, see Table-4.
	If the surface of the touch control panel is exposed to intense vapour, the entire control system may become deactivated and give error signal.
	Keep the surface of the touch control panel clean. Erroneous operation may be observed.

5 Maintenance and care

General information

Service life of the product will extend and the possibility of problems will decrease if the product is cleaned at regular intervals.



DANGER

Disconnect the product from mains supply before starting maintenance and cleaning works.

There is the risk of electric shock!



DANGER

Allow the product to cool down before you clean it.

Hot surfaces may cause burns!

- Clean the product thoroughly after each use. In this way it will be possible to remove cooking residues more easily, thus avoiding these from burning the next time the appliance is used.
- No special cleaning agents are required for cleaning the product. Use warm water with washing liquid, a soft cloth or sponge to clean the product and wipe it with a dry cloth.
- Always ensure any excess liquid is thoroughly wiped off after cleaning and any spillage is immediately wiped dry.
- Do not use cleaning agents that contain acid or chloride to clean the stainless or inox surfaces and the handle. Use a soft cloth with a liquid detergent (not abrasive) to wipe those parts clean, paying attention to sweep in one direction.



The surface might get damaged by some detergents or cleaning materials.

Do not use aggressive detergents, cleaning powders/creams or any sharp objects during cleaning.

Do not use harsh abrasive cleaners or sharp metal scrapers to clean the oven door glass since they can scratch the surface, which may result in shattering of the glass.



Do not use steam cleaners to clean the appliance as this may cause an electric shock.

Cleaning the burner/plate

Ceramic hobs

Always rinse off fully with a clean cloth wrung out in clean water (as residue could damage the ceramic glass surface next time the hob is used). In no case should crusts be scratched off with serrated edge knives, steel wool or the like. Remove calcium stains (yellow staining) with small amounts of decalcifying agents such as Durgol, vinegar or lemon juice.

Do not allow vinegar, coffee, milk, saltwater, lemon or tomato juice to remain in contact with enamel parts (i.e. inside the oven).

Apply agent with a sponge and, in the event of heavier soiling, let it work in for a longer period of time. Afterwards, wash off hob with water.



WARNING:

Sugar-based food such as custard and syrup should immediately be scraped off without waiting for the surface to cool down. Otherwise the burner/plate may be permanently damaged.

Cleaning the control panel

Clean the control panel with a damp cloth and wipe them dry.

6 General information

Overview

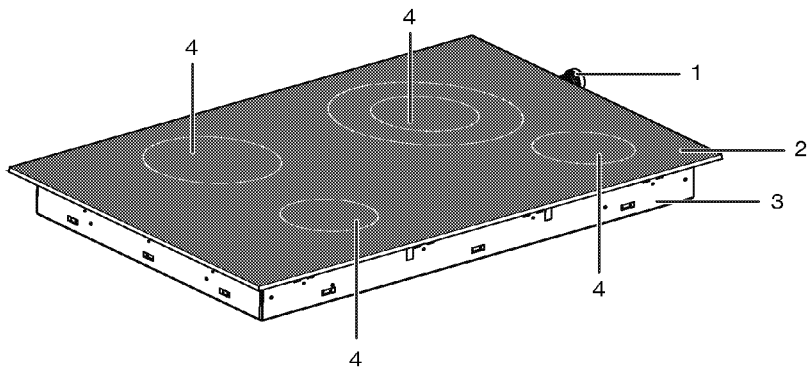

- | | | | |
|---|---------------|---|---------------|
| 1 | Power cable | 3 | Base cover |
| 2 | Cooktop glass | 4 | Cooking zones |

Technical specifications

Voltage / frequency	120/240V~60Hz
Total power consumption	4.8 kW
Fuse	30 A
Cable type / section	BC-SIL 3x10 AWG
Cable length	min. 4 ft - max. 6ft
External dimensions (height / width / depth)	2" 5/8 (67mm) (3" 13/16 (97 mm) –including power cable)/24" 3/16 (614 mm) /20" 15/16 (532 mm)
Installation dimensions (width / depth)	22-13/16" (580 mm) / 19-5/8" (498 mm)
Cooking plates	
Front right	Single-circuit cooking plate
Dimension	4 inches
Power	700 W
Front left	Single-circuit cooking plate
Dimension	4 inches
Power	700 W
Rear left	Single-circuit cooking plate
Dimension	5,5 inches
Power	1200 W
Rear right	Dual-circuit cooking plate
Dimension	4, 7 - 8,3 inches
Power	750- 2200 W



Technical specifications may be changed without prior notice to improve the quality of the product.



Figures in this manual are schematic and may not exactly match your product.



Values stated on the product labels or in the documentation accompanying it are obtained in laboratory conditions in accordance with relevant standards. Depending on operational and environmental conditions of the product, these values may vary.

7 Troubleshooting

Product emits metal noises while heating and cooling.

- When the metal parts are heated, they may expand and cause noise. >>> *This is not a fault.*

Product does not operate.

- The mains fuse is defective or has tripped. >>> *Check fuses in the fuse box. If necessary, replace or reset them.*
- Product is not plugged into the (grounded) socket. >>> *Check the plug connection.*
- If the display does not light up when you switch the hob on again. >>> *Disconnect the appliance at the circuit breaker. Wait 20 seconds and then reconnect it.*



Consult the Authorised Service Agent or technician with licence or the dealer where you have purchased the product if you can not remedy the trouble although you have implemented the instructions in this section. Never attempt to repair a defective product yourself.

8 BEKO US RESIDENTIAL PRODUCT WARRANTY

The warranties provided by Beko in these statements only apply to Beko appliance sold to the original purchaser or homeowner in the US (Including Alaska, Hawaii, Puerto Rico and the US Virgin Islands) and The Cayman Islands

The factory warranty applies only to products purchased through an authorized dealer or authorized reseller. Go to www.bekoappliances.com/where-to-buy for a list of authorized dealers. Products purchased through non-authorized dealers and wholesalers will not be covered under the manufactures warranty

The warranty is not transferable. To obtain warranty service, please contact your dealer or contact us at

<https://www.bekoappliances.com/support/beforecallcenter/>

You will need your product model number, serial number, retailer name and address, where purchased and purchase date / installation date. This warranty gives you specific legal rights, and you may also have other rights which vary from state to state. Also, please make sure you register your product for warranty at:

<https://www.bekoappliances.com/product-registration/>

2 year (*) full warranty from date of first Installation (All Beko Products)

Beko will repair or replace at no cost to the consumer any defective parts product if used under normal household conditions

(Warranty is void if the product is used commercially e.g., bed + breakfast, nursing home etc.). Service must also be performed by an authorized Beko service agency. (Cosmetic defects must be reported within 10 business days from installation). 1 year warranty on the accessories is for the parts only and does not include labor.

3rd thru 5th year (*, **) Sealed System Warranty on refrigerators - Parts Only

Beko will provide (No Charge) any compressor, evaporator, condenser and filter Dryer to the consumer if material defects or workmanship have caused the damage or failure of these components.

(Trip and Labor charges are the responsibility of the consumer)

3rd thru 10th year (*, **) ProSmart™ Inverter Motor on Dishwashers – Part Only

Beko will provide (No Charge) a ProSmart Inverter Main Wash Motor if material defects or workmanship have caused the damage or failure of this component.

(Trip and Labor charges are the responsibility of the consumer)

Disclaimers of warranties and exclusions:

Warranty does not cover service costs by an authorized service agent to correct installation, electrical problems or educational instruction on the use of the electric and gas ranges. The warranty also does not cover defects or damage caused by an act of God (such as storms, floods, fires, mudslides, etc.), damage cause by use of the electric and gas ranges for purposes other than those for

which it was designed, misuse, abuse, accident, alteration, improper installation, maintenance, travel fees, service calls outside normal service hours, pick up and delivery, any food loss due to product failure, unauthorized service work or work.

This product is fully tested and went through official quality assurance inspections before leaving the original manufacturing site. Warranty terms for this Beko household appliance is not valid if the product is altered, tampered, modified, additional parts assembled, fixed and re-packed by an authorized distributor, servicer, a third party retailer, reseller or by any other unauthorized person(s).

TO THE EXTENT PERMITTED BY LAW, THIS WARRANTY IS IN LIEU OF ALL OTHER EXPRESSED AND IMPLIED WARRANTIES, INCLUDING THE IMPLIED WARRANTIES OF MERCHANTABILITY AND FITNESS FOR A PARTICULAR PURPOSE. BEKO UNDERTAKES NO RESPONSIBILITY FOR THE QUALITY OF THIS PRODUCT EXCEPT AS OTHERWISE PROVIDED IN THIS WARRANTY STATEMENT. BEKO ASSUMES NO RESPONSIBILITY THAT THE PRODUCT WILL BE FIT FOR ANY PARTICULAR PURPOSE FOR WHICH YOU MAY BE BUYING THIS PRODUCT, EXCEPT AS OTHERWISE PROVIDED IN THIS WARRANTY STATEMENT.

Beko does not assume any responsibility for incidental or consequential damages. Such damages include, but are not limited to, loss of profits, loss of savings or revenue, loss of use of the electric and gas ranges or any associated equipment, cost of capital, cost of any substitute equipment, facilities or services, downtime, the claims of third parties, and injury to property. Some states do not allow the exclusion or limitation of incidental or consequential damages, so the above limitations or exclusion may not apply to you.

(*) Installation date shall refer to either purchase date or 5 business days after delivery of the product to the home, whichever is later.

() Parts replaced will assume the identity of the original parts + their original warranty.**

No Other Warranties. This Warranty Statement is the complete and exclusive warranty from the manufacturer. No employee of Beko or any other party is authorized to make any warranty statements in addition to those made in this Warranty Statement.

Please keep this warranty card, user manual and your sales slip for future reference.

HOW TO CONTACT BEKO

Please contact Beko US at 1 (888) 352-2356 and select option 2 for customer service

HOW TO GET SERVICE

Please contact your authorized Beko dealer or visit www.bekoappliances.com to locate and get information for the closest authorized Beko service center.

