

Tower Fan

User Manual

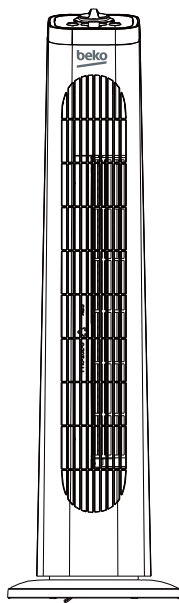

EFW5100W

EN | RO | IT | DE | FR | NL

01M-8899823200-5020-02

beko







Please read this user manual first!

Dear Customer,

Thank you for preferring a Beko product. We hope that you get the best results from your product which has been manufactured with high quality and state-of-the-art technology. Therefore, please read this entire user manual and all other accompanying documents carefully before using the product and keep it as a reference for future use. If you handover the product to someone else, give the user manual as well. Follow all warnings and information in the user manual.

Meanings of the symbols

Following symbols are used in the various section of this manual:

	Important information or useful hints about usage.		Warning for danger of fire.
	Warning for hazardous situations with regard to life and property.		Warning for hot surfaces.
	Warning to actions that must never perform.		Do not cover it.
	Warning for electric shock.		



This product has been produced in environmentally friendly, modern facilities

Complies with the WEEE Regulation.



Does not contain PCB.

CONTENTS

1 Safety instructions	4
2 Installation instructions	6
2.1 Name of components	6
3 Installation of use	8
4 Other	9
4.1 Maintenance instructions.....	9
4.2 Cleaning.....	9
4.3 Technical data.....	9
5 Disposal	10

1 Safety instructions

Warning

Read rules for safe operation and instructions carefully.

- If the supply cord is damaged, it must be replaced by manufacturer or its service agent or a similarly qualified person in order to avoid a hazard.
- Indoor use only.
- To protect against the risk of electrical shock, do not immerse the unit, cord or plug in water or other liquid.
- This appliance can be used by children aged from 8 years and above and persons with reduced physical, sensory or mental capabilities or lack of experience and knowledge if they have been given supervision or instruction concerning use of the appliance in a safe way and understand the hazards involved. Children shall not play with the appliance. Cleaning and user maintenance shall not be made by children without supervision. Children should be supervised to ensure that they do not play with the appliance.
- When the appliance is not in use and before cleaning, unplug the appliance from the outlet.
- When the fan was assembled, the rotor blade guard shall not be taken off anymore.
- Correct disposal of this product.
-  This marking indicates that this product should not be disposed with other household wastes throughout the EU. To prevent possible harm to the environment or human health from uncontrolled waste disposal, recycle it responsibly to promote

1 Safety instructions

the sustainable reuse of material resources. To return your used device, please use the return and collection systems or contact the retailer where the product was purchased. They can take this product for environmental safe recycling.

- This appliance is not intended for use by persons (including children) with reduced physical, sensory or mental capabilities, or lack of experience and knowledge, unless they have been given supervision or instruction concerning use of the appliance by a person responsible for their safety.
- If the instructions state that the guard has to be removed for cleaning purposes, the instructions shall state the substance of the following:
Ensure that the fan is switched off from the supply mains before removing the guard.

Rules for safe operation

- Never insert fingers, pencils, or any other object through the grille when fan is running.
- Disconnect fan when moving from one location to another.
- Be sure fan is on a stable surface when operating to avoid overturning.
- Do not use fan in window, rain may create electrical hazard.
- Household use only.

2 Installation instructions

2.1 Name of components

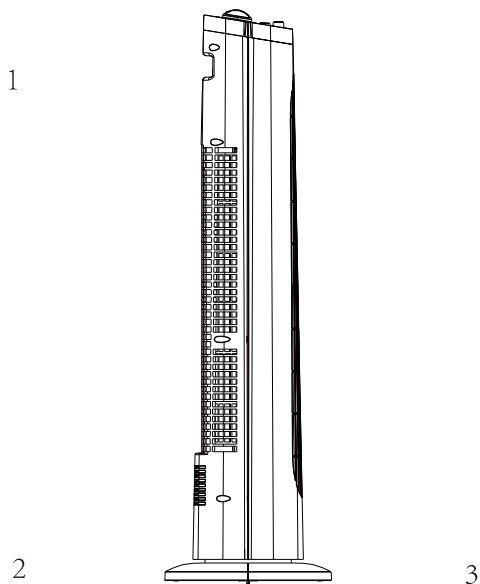

1. Fan body

2. Base A

3. Base B

2 Installation instructions

Install the Base

Step 1

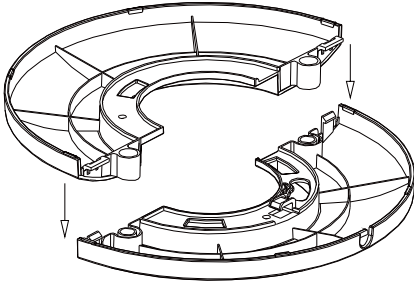

1. Put the two halves of the base together. See step 1.

Step 2

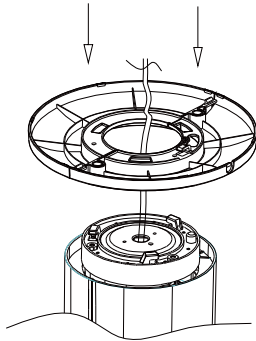

2. Position the base on the bottom of the fan, put the power cord through the base and make sure clasps on tower fan body is align with the holes on the base. See step 2.

Step 3

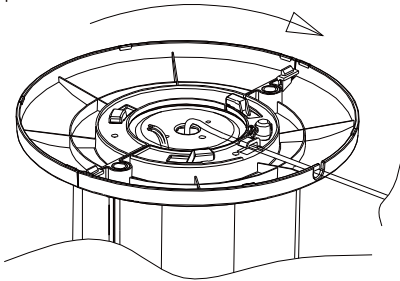

3. Then rotate the base clockwise until the it is locked. Finally thread the power cord into the guide on the bottom of the base by gently pressing the wire into the clamps. See step 3.

3 Installation of use

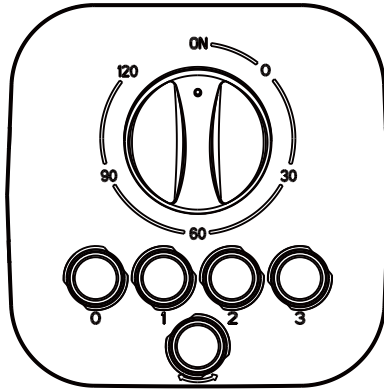

Controls: Press selection button to choose desired speed.

"1" for low,

"2" for medium,

"3" for high,

"0" for power off

Oscillation: Press the "↔" button on the top of the fan begin oscillation. Press again to stop.

Timer: 2 hours timer

For timer operation, turn the timer control clockwise to operate the fan for the selected duration.



Warm tips

Do not rotate the timer counter-clockwise to "ON" from "120".

4.1 Maintenance instructions

The fan requires little maintenance. Do not try to fix it by yourself. Refer it to qualified service personnel if service is needed.

1. Before cleaning and assembling, fan must be unplugged.
2. To ensure adequate air circulation to the motor, keep vents at the rear of the motor free of dust. Do not disassemble the fan to remove dust.
3. Please wipe the exterior parts with a soft cloth soaking a mild detergent.
4. Do not use any abrasive detergent or solvents to avoid scratching the surface. Do not use any of the following as a cleaner: gasoline, thinner.
5. Do not allow water or any other liquid into the motor housing or interior parts.

4.2 Cleaning

1. Be sure to unplug from the electrical supply source before cleaning.
2. Plastic parts should be cleaned with a soft cloth moisten with mild soap. Thoroughly remove soap film with dry cloth.

4.3 Technical data

Power supply: 220-240V~, 50Hz

Technical and design modifications reserved.

5 Disposal



Note: Do not dispose of electrical appliances as unsorted municipal waste, use separate collection facilities. Contact your local government for information regarding the collection systems available. If electrical appliances are disposed of in landfills or dumps, hazardous substances can leak into the groundwater and get into the food chain, damaging your health and well-being.



This product complies with EU WEEE Directive (2012/19/EU). This product bears a classification symbol for waste electrical and electronic equipment (WEEE). This symbol indicates that this product shall not be disposed with other household wastes at the end of its service life. Used device must be returned to official collection point for recycling of electrical and electronic devices. To find these collection systems please contact to your local authorities or retailer where the product was purchased. Each household performs important role in recovering and recycling of old appliance. Appropriate disposal of used appliance helps prevent potential negative consequences for the environment and human health.

Information			
Description	Symbol	Value	Unit
Maximum fan flow rate	F	10	m ³ /min
Fan power input	P	35	W
Service value	SV	0,29	(m ³ /min)/W
Standby power consumption	P _{SB}	0	W
Fan sound power level	L _{WA}	62	dB(A)
Maximum air velocity	C	5,0	meters/sec
Measurement standard for service value	IEC 60879: 1986+ (corr. 1992)		
Contact details for obtaining more information	Arcelik: Arcelik AS. Sutluce. Karaagac Cd. 2-6, 34445 Beyoglu Istanbul Turkey		

Importer in Poland Importer w Polsce Beko S.A. ul. Puławska 366 02-819 Warszawa www.beko.pl	Importer in Czech Republic Dovožce do České republiky BEKO S.A., organizační složka Bucharova 1423/6, Praha 13 – Nové Butovice, 158 00 www.bekocr.cz	Importer in Slovakia Dovožca na Slovensko BEKO Slovakia s.r.o. Suché myto 1 811 03 Bratislava www.bekosk.sk	Importer in Estonia Importija Eesti Beko S.A. Tänav Puławaska 366 02-819 Varssavi (Poola)	Importer in Norway Karenslyst Allé 2 0278 Oslo
Importer in UK BEKO Plc, Beko House, 1 Greenhill Crescent, Watford, Herts, WD18 8QU	Importer in Germany Beko Grundig Deutschland GmbH Thomas-Edison-Platz 3 63263 Neu-Isenburg	KSA Importer HUSSEIN & ALHASSAN G. SHAKER BROS. FOR MODERN TRADING CO. LTD. Hail Street – Al Bughdadiyah Al Gharbeyah District Shaker Building – 6th floor (+966)126454227	Importer in France BEKO France / Immeuble Stadium, 266, Avenue du Président Wilson 93218 La Plaine Saint-Denis Cedex	
Importer in Spain BEKO ELECTRONICS ESPANA S.L.C/ Provenza, 388. 3a planta, 08025 Barcelona	Importer for Malta ETV LTD 119/120 Archbishop Street VALLETTA MALTA	Importer in Latvia Importētāja Latvijā Beko S.A. Ielas Puļawska 366 02-819 Varšava (Polija)	Importer in Switzerland Secomp AG Grindelstrasse 6 CH-8303 Bassersdorf Switzerland	Importer in Lithuania Importuotojas Lietuvoje Beko S.A. Gatvė Puļawska 366 02-819 Varšuva (Lenkija)
Importer in Austria ELEKTRA BREGENZ AG PFARRGASSE 77 VIENNA post code 1230	Importer in Sweden Grundig Nordic AB Klarabergsviadukten SE-11164 Stockholm	Importer in Hungary Hauser Magyarorszag imited Baross utca 89 PC: 2040 Budaörs / Hungary	Importer in Slovenia BIG BANG, D.O.O. Šmartinska cesta 152 PC: 1000 Ljubljana/Slovenia	Importer in Italy BEKO ITALY SRL Viale Del Ghisallo, 201/20151 Milano (MI)
Importer in Romania ARCTIC S.A. Str. 13 Decembrie, nr.210 Găești, 135200, România www.arctic.ro	Importer in Belgium Asogem NV/SA Schalihenoevedreef 26 2800 Mechelen Belgium	Importer in Greece PAR. SEITANIDIS S.A. Polistilo, P.O. Box:1402 Kavala, 64003	Importer in Bulgaria VIDEOLUX Ltd. 265, Okolovrasten pat Str. Mladost 4, 1766 Sofia, Bulgaria	Importer in Croatia E PLUS doo ZA Unamrju / GOSPODARSKA 16c / 10225 GORNJI STUPNIK / ZAGREP
Importer in Russia Импортёр на территории РФ: ООО «БЕКО», РФ, 601021, Владимирская обл., Киржачский р-н Муниципальное образование сельское поселение Першинское, дер. Федоровское, ул. Сельская, д. 49 Бесплатная линия сервисного обслуживания и информационной поддержки по установке и эксплуатации (только для звонков по России) 8-800-200-23-56 Изготовитель: Arcelik A.Ş. Турция, Karaağaç Caddesi No: 2-6 Istanbul 34445 Sutluce, Istanbul				
Виробник: "Arçelik A.S." Karaağaç Caddesi No: 2-6 Sütlüce, 34445, Turkey/ "Arçelik A.S.", м. Стамбул, Сютлюдже, вул. Караагач № 2-6, 34445, Туреччина, Термін служби 10 років Імпортер на території України: ТОВ «Бекo Україна», адреса: 03150, м. Київ, вул. Антоновича, буд. 72 тел/факс.: 0-800-500-4-3-2				
Manufactured by Arcelik A.S. Karaagac Cd. No:2-6 34445 Sutluce, Beyoglu, Istanbul, Turkey SDA-HVAC-11-20-05				

Vă rugăm să consultați în prealabil acest manual de utilizare!

Stimate client,

Vă mulțumim că ați ales un produs Beko. Sperăm că veți obține cele mai bune rezultate cu acest produs, care a fost fabricat cu o înaltă calitate și folosind tehnologia cea mai modernă. De aceea, înainte de a folosi produsul, vă rugăm să consultați în întregime manualul de utilizare și toate celelalte documente aferente acestuia ce servesc drept referință pentru utilizări ulterioare. Dacă încredințați produsul unei alte persoane, oferiți, de asemenea, și manualul de utilizare. Respectați toate atenționările și informațiile din manualul de utilizare.

Semnificația simbolurilor

În diferitele capitole ale acestui manual, veți întâlni următoarele simboluri:



Informații importante sau sfaturi utile cu privire la utilizare.



Avertizare asupra situațiilor care pot pune în pericol viața și bunurile materiale.



Avertizare pentru acțiuni ce nu trebuie niciodată întreprinse.



Avertizare pentru electrocutare.



Avertizare pentru pericol de incendiu.



Avertizare pentru suprafețe fierbinți.



Nu acoperiți.



Acest produs a fost fabricat în condiții moderne cu respectarea normelor de protecție a mediului

Produsul este în conformitate cu Regulamentul privind DEEE.



Nu conține PCB.

CUPRINS

1 Instrucțiuni de siguranță	14
2 Instrucțiuni de instalare	17
2.1 Denumirea componentelor	17
3 Instalarea pentru utilizare	19
4 Alte instrucțiuni	20
4.1 Instrucțiuni de întreținere.....	20
4.2 Curățare.....	20
4.3 Date tehnice	20
5 Eliminarea	21

1 Instrucțiuni de siguranță

Avertizare

Citiți cu atenție instrucțiunile și regulile pentru o utilizare sigură.

- În cazul în care cablul de alimentare este deteriorat, acesta trebuie să fie înlocuit fie de către producător, de un reprezentant al serviciului sau de o persoană calificată pentru a evita un pericol.
- Doar pentru uz în interior.
- Pentru a vă proteja împotriva riscului de electrocutare, nu introduceți unitatea, cablul sau fișa în apă sau alt lichid.
- Acest aparat poate fi utilizat de copiii cu vârsta de peste 8 ani precum și de persoanele cu capacități fizice, senzoriale sau mentale reduse sau persoane cărora le lipsesc experiența și cunoștințele, doar în cazul în care li se asigură supraveghere sau primesc instrucțiuni pentru utilizarea în condiții de siguranță și informații asupra riscurilor implicate. Copiii nu trebuie să se joace cu acest aparat. Curățarea și întreținerea utilizatorilor nu trebuie efectuate de copii fără supraveghere. Copiii trebuie supravegheați pentru a se asigura că nu se joacă cu aparatul.
- Când aparatul nu este utilizat și înainte de curățare, deconectați aparatul de la priză.
- După ce ventilatorul a fost asamblat, nu mai este voie să scoateți protecția lamei rotorului.
- Eliminarea corectă a acestui produs

1 Instrucțiuni de siguranță



- Acest marcaj indică faptul că acest produs nu trebuie să fie aruncat împreună cu alte deșeuri menajere, regulă valabilă pe întreg teritoriul UE. Pentru a preveni posibilele efecte dăunătoare asupra mediului sau a sănătății umane cauzate de eliminarea necontrolată a deșeurilor, reciclați-l într-un mod responsabil pentru a promova reutilizarea durabilă a resurselor materiale. Pentru a returna dispozitivul utilizat, vă rugăm să folosiți sistemele de returnare și colectare sau să contactați distribuitorul de la care a fost achiziționat produsul. Acesta poate prelua acest produs pentru a efectua reciclarea sa ecologică.
- Acest aparat nu este destinat utilizării de către persoane (inclusiv copii) cu capacități fizice, senzoriale sau mentale reduse sau care nu dispun de experiență și cunoștințe, în cazul în care nu sunt supravegheate sau instruite în legătură cu utilizarea aparatului de către o persoană responsabilă pentru siguranța lor.
- Dacă instrucțiunile indică faptul că dispozitivul de protecție trebuie îndepărtat pentru curățare, instrucțiunile trebuie să conțină substanța următoarelor:
Asigurați-vă că ventilatorul este deconectat de la rețeaua de alimentare înainte de a scoate folia protectoare din plastic.

1 Instrucțiuni de siguranță

Reguli de securitate

- Nu introduceți niciodată degetele, creioane sau orice alt obiect prin grilă atunci când ventilatorul funcționează.
- Deconectați ventilatorul atunci când îl mutați dintr-o locație în alta.
- Asigurați-vă că, în timp ce funcționează, ventilatorul este pe o suprafață stabilă, pentru a evita răsturnarea.
- Nu folosiți ventilatorul lângă fereastră, ploaia poate crea pericole electrice.
- Numai pentru uz casnic.

2 Instrucțiuni de instalare

2.1 Denumirea componentelor

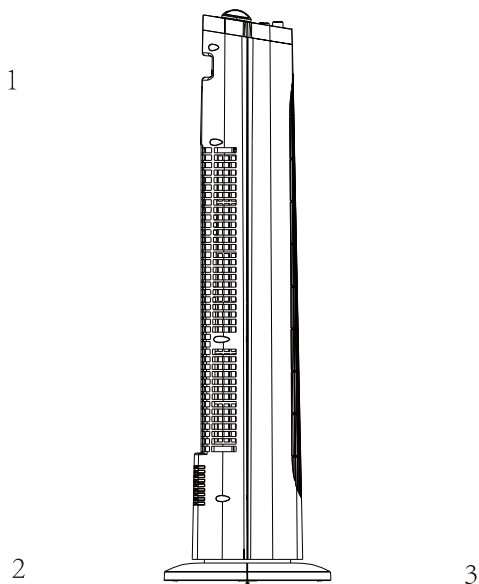

1. Corpul ventilatorului

2. Baza A

3. Baza B

2 Instrucțiuni de instalare

Instalați baza

Pasul 1

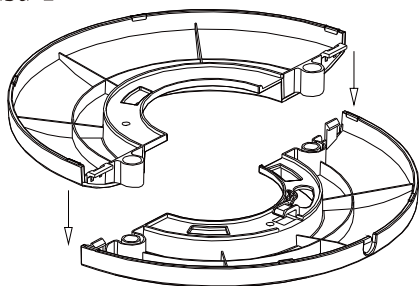

1. Puneți împreună cele două jumătăți ale bazei. Vedeți pasul 1.

Pasul 2

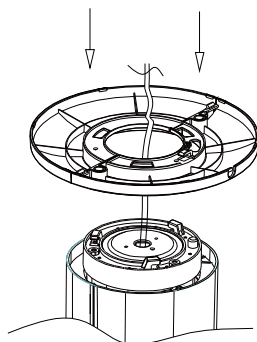

2. Poziționați baza în partea de jos a ventilatorului, introduceți cablul de alimentare prin bază și asigurați-vă că clemele de pe carcasa ventilatorului sunt aliniat în drept cu găurile de pe bază. Vedeți pasul 2.

Pasul 3

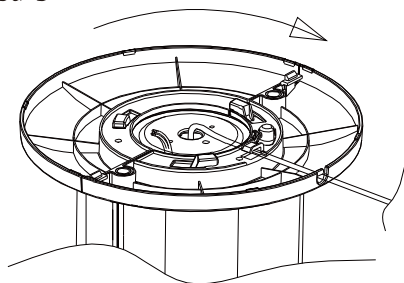

3. Apoi rotiți baza în sensul acelor ceasornicului până aceasta se va bloca. În cele din urmă, introduceți cablul de alimentare în conducător din partea de jos a bazei, apăsând ușor firul printre cleme. Vedeți pasul 3.

3 Instalarea pentru utilizare

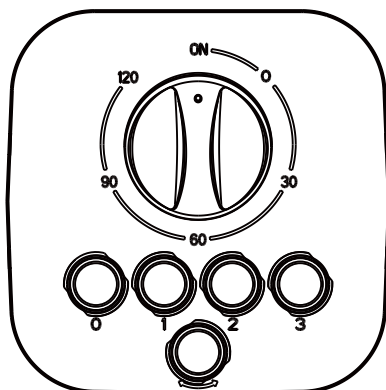

Comenzi: Pentru a alege viteza dorită, selectați butonul de selecție.

"1" pentru slab,

"2" pentru mediu,

"3" pentru puternic,

"0" pentru a opri

Oscilație: Apăsați butonul "↔" din partea de sus a ventilatorului pentru a începe oscilația. Apăsați din nou pentru a opri.

Temporizator: Temporizator 2 ore

Pentru funcționarea temporizatorului, rotiți butonul temporizatorului în sensul acelor ceasornicului pentru durata aleasă.



Sfaturi simple

Nu rotiți cronometrul în sens invers acelor de ceasornic în poziția „ON” (PORNIT) de la „120”.

4 Alte instrucțiuni

4.1 Instrucțiuni de întreținere

Ventilatorul necesită puțină întreținere. Nu încercați să-l reparați de unul singur. Dacă este necesară o reparație, adresați-vă personalului de service calificat.

1. Deconectați ventilatorul înainte de curățare și asamblare.
2. Împiedicați acumularea prafului în orificiile de ventilare din spatele motorului pentru a asigura o circulație adecvată a aerului către motor. Nu dezasamblați ventilatorul pentru a îndepărta praful.
3. Vă rugăm să ștergeți părțile exterioare cu o cârpă moale, îmbibată cu un detergent moale.
4. Nu folosiți detergenți sau solvenți abrazivi pentru a evita zgârierea suprafeței. Nu utilizați niciunul dintre următoarele ca produs de curățare: benzină, dizolvant.
5. Nu permiteți pătrunderea apei sau oricărui alt lichid în carcasa motorului sau în părțile interioare.

4.2 Curățare

1. Înainte de curățare, asigurați-vă că deconectați aparatul de la sursa de alimentare electrică.
2. Părțile din plastic trebuie curățate cu o cârpă moale, înmuiată în săpun delicat. Îndepărtați cu grijă resturile de săpun cu ajutorul unei cârpe uscate.

4.3 Date tehnice

Alimentare electrică: 220-240 V~, 50 Hz

Modificări tehnice și de proiectare rezervate.

5 Eliminarea



Notă: Nu aruncați aparatele electrice ca deșeuri municipale nesortate, folosiți facilitățile de colectare separată. Contactați administrația locală pentru informații cu privire la sistemele de colectare disponibile. Dacă aparatele electrice sunt aruncate în gropile de gunoi sau în halde, substanțele periculoase se pot scurge în apele subterane și pot intra în lanțul alimentar, afectându-vă sănătatea și bunăstarea.



Acest produs respectă Directiva UE WEEE (2012/19/UE). Produsul este marcat cu un simbol de clasificare pentru deșeuri electrice și electronice (WEEE).

Acest simbol indică faptul că produsul nu trebuie eliminat cu alte deșeuri menajere la finalul perioadei de utilizare. Dispozitivele utilizate trebuie returnate la punctul special de reciclare de dispozitive electrice și electronice. Pentru a găsi aceste sisteme de colectare contactați autoritățile locale sau distribuitorul de la care a fost achiziționat produsul. Fiecare gospodărie are un rol important în recuperarea și reciclarea electrocasnicelor vechi. Eliminarea corespunzătoare a electrocasnicelor utilizate ajută la prevenirea posibilelor consecințe negative pentru mediu și sănătatea umană.

Informație

Descriere	Simbol	Valoare	Unitate
Debitul maxim de aer al ventilatorului	F	10	m ³ /min
Alimentarea electrică a ventilatorului	P	35	W
Valoarea serviciului	SV	0,29	(m ³ /min)/W
Consum de energie în modul de așteptare	P _{SB}	0	W
Nivelul de putere a sunetului ventilatorului	L _{WA}	62	dB(A)
Viteza maximă a aerului	C	5,0	m/s
Standard de măsurare pentru valoarea serviciului	IEC 60879: 1986+ (cor. 1992)		
Detalii de contact pentru a obține mai multe informații	Arcelik: Arcelik AS. Sutluce. Karaagac Cd. 2-6, 34445 Beyoglu Istanbul Turcia		

Importer in Poland Importer w Polsce Beko S.A. ul. Puławska 366 02-819 Warszawa www.beko.pl	Importer in Czech Republic Dovožce do České republiky BEKO S.A., organizační složka Bucharova 1423/6, Praha 13 – Nové Butovice, 158 00 www.bekocr.cz	Importer in Slovakia Dovožca na Slovensko BEKO Slovakia s.r.o. Suché myto 1 811 03 Bratislava www.bekosk.sk	Importer in Estonia Importija Eesti Beko S.A. Tänav Puulawska 366 02-819 Varssavi (Poola)	Importer in Norway Karenslyst Allé 2 0278 Oslo
Importer in UK BEKO Plc, Beko House, 1 Greenhill Crescent, Watford, Herts, WD18 8QU	Importer in Germany Beko Grundig Deutschland GmbH Thomas-Edison-Platz 3 63263 Neu-Isenburg	KSA Importer HUSSEIN & ALHASSAN G. SHAKER BROS. FOR MODERN TRADING CO. LTD. Hail Street – Al Bughdadiyah Al Gharbeyah District Shaker Building – 6th floor (+966)126454227	Importer in France BEKO France / Immeuble Stadium, 266, Avenue du Président Wilson 93218 La Plaine Saint-Denis Cedex	
Importer in Spain BEKO ELECTRONICS ESPANA S.L.C/ Provenza, 388. 3a planta, 08025 Barcelona	Importer for Malta ETV LTD 119/120 Archbishop Street VALLETTA MALTA	Importer in Latvia Importētāja Latvijā Beko S.A. Ielas Puļawska 366 02-819 Varšava (Polija)	Importer in Switzerland Secomp AG Grindelstrasse 6 CH-8303 Bassersdorf Switzerland	Importer in Lithuania Importuotojas Lietuvoje Beko S.A. Gatvė Puļawska 366 02-819 Varšuva (Lenkija)
Importer in Austria ELEKTRA BREGENZ AG PFARRGASSE 77 VIENNA post code 1230	Importer in Sweden Grundig Nordic AB Klarabergsviadukten SE-11164 Stockholm	Importer in Hungary Hauser Magyarorszag imited Baross utca 89 PC: 2040 Budaörs / Hungary	Importer in Slovenia BIG BANG, D.O.O. Šmartinska cesta 152 PC: 1000 Ljubljana/Slovenia	Importer in Italy BEKO ITALY SRL Viale Del Ghisallo, 201/20151 Milano (MI)
Importer in Romania ARCTIC S.A. Str. 13 Decembrie, nr.210 Găești, 135200, România www.arctic.ro	Importer in Belgium Asogem NV/SA Schalihenoevedreef 26 2800 Mechelen Belgium	Importer in Greece PAR. SEITANIDIS S.A. Polistilo, P.O. Box:1402 Kavala, 64003	Importer in Bulgaria VIDEOLUX Ltd. 265, Okolovrasten pat Str. Mladost 4, 1766 Sofia, Bulgaria	Importer in Croatia E PLUS doo ZA Unamrju / GOSPODARSKA 16c / 10225 GORNJI STUPNIK / ZAGREP
Importer in Russia Импортёр на территории РФ: ООО «БЕКО», РФ, 601021, Владимирская обл., Киржачский р-н Муниципальное образование сельское поселение Першинское, дер. Федоровское, ул. Сельская, д. 49 Бесплатная линия сервисного обслуживания и информационной поддержки по установке и эксплуатации (только для звонков по России) 8-800-200-23-56 Изготовитель: Arcelik A.Ş. Турция, Karaağaç Caddesi No: 2-6 Istanbul 34445 Sutluce, Istanbul				
Виробник: "Arçelik A.S." Karaağaç Caddesi No: 2-6 Sütlüce, 34445, Turkey/ "Arçelik A.S.", м. Стамбул, Сютлюдже, вул. Караагач № 2-6, 34445, Туреччина, Термін служби 10 років Імпортер на території України: ТОВ «Бекo Україна», адреса: 03150, м. Київ, вул. Антоновича, буд. 72 тел/факс.: 0-800-500-4-3-2				
Manufactured by Arcelik A.S. Karaagac Cd. No:2-6 34445 Sutluce, Beyoglu, Istanbul, Turkey SDA-HVAC-11-20-05				

Prima dell'utilizzo, leggere il presente manuale.

Gentile Cliente,

grazie per aver scelto un prodotto Beko. Ci auguriamo che possa essere soddisfatto del prodotto che è stato realizzato secondo elevati standard di qualità e con una tecnologia all'avanguardia. Pertanto, prima di utilizzare il prodotto, legga attentamente tutto il manuale e i documenti che lo accompagnano avendo cura di conservarli per un riferimento futuro. Se cede il prodotto a terzi, fornisca anche il manuale utente. Segua tutte le avvertenze e le informazioni riportate nel presente manuale.

Significato dei simboli

I seguenti simboli sono utilizzati in diverse sezioni del presente manuale:

	Informazioni importanti o suggerimenti pratici sull'utilizzo.
--	---

	Avvertenza: situazioni che mettono a rischio l'incolumità di persone o cose.
--	--

	Avvertenza: operazioni da non eseguire mai.
--	---

	Attenzione: rischio di scosse elettriche.
---	---

	Attenzione al pericolo di incendi.
---	------------------------------------

	Attenzione alle superfici calde.
---	----------------------------------

	Non coprirlo.
---	---------------



Il presente prodotto è stato realizzato in strutture ecosostenibili e moderne

SOMMARIO

1 Istruzioni per la sicurezza	25
2 Istruzioni per l'installazione	28
2.1 Nome dei componenti	28
3 Utilizzo	30
4 Istruzioni supplementari	31
4.1 Istruzioni per la manutenzione	31
4.2 Pulizia	31
4.3 Dati tecnici	31
5 Smaltimento	32

1 Istruzioni per la sicurezza

Attenzione

Leggere attentamente le regole e le istruzioni per il funzionamento sicuro.

- Se il cavo di alimentazione è danneggiato, deve essere sostituito dal produttore, dal servizio di assistenza o da personale qualificato al fine di evitare rischi.
- Solo per uso in interni.
- Per proteggersi dal rischio di scosse elettriche, non immergere l'unità, il cavo o la spina in acqua o altri liquidi.
- Questo elettrodomestico può essere utilizzato dai bambini dagli 8 anni in su e dalle persone con capacità fisiche, sensoriali o mentali ridotte, anche in caso di mancata esperienza o conoscenza, solo se controllati e istruiti all'uso sicuro dell'elettrodomestico e informati sui possibili rischi. Non consentire ai bambini di giocare con l'apparecchio. La pulizia e la manutenzione non devono essere effettuate dai bambini senza sorveglianza. I bambini devono essere sorvegliati per assicurarsi che non giochino con l'elettrodomestico.
- Quando l'apparecchio non è in uso e prima della pulizia, scollegarlo dalla presa di corrente.
- Una volta montato il ventilatore, la griglia di protezione della pala del rotore non deve essere più tolta.
- Smaltimento corretto del prodotto.

1 Istruzioni per la sicurezza



- Questo simbolo indica che questo prodotto non deve essere smaltito con i rifiuti domestici nell'UE. Per evitare possibili danni all'ambiente o alla salute derivanti da smaltimento di rifiuti abusivo, riciclare il dispositivo in maniera responsabile per promuovere un riutilizzo sostenibile delle risorse. Per restituire il dispositivo usato, utilizzare i sistemi di raccolta e recupero o rivolgersi al rivenditore dove è stato acquistato il prodotto. In questo modo è possibile effettuare il riciclaggio sicuro nel rispetto dell'ambiente.
- Questo elettrodomestico non è destinato all'utilizzo da parte di persone (compresi i bambini) con capacità fisiche, sensoriali o mentali ridotte o che non posseggono la dovuta esperienza e conoscenza, a meno che non siano controllate o istruite all'uso dell'elettrodomestico da una persona responsabile della loro sicurezza.
- Se le istruzioni indicano che la protezione deve essere rimossa per la pulizia, devono indicare la sostanza di quanto segue: Assicurarsi che il ventilatore non sia collegato alla rete elettrica prima di rimuovere la griglia di protezione.

1 Istruzioni per la sicurezza

Regole per il funzionamento sicuro

- Non inserire mai dita, matite o altri oggetti attraverso la griglia mentre la ventola è in movimento.
- Scollegare il ventilatore quando lo si sposta da un luogo a un altro.
- Durante il funzionamento, accertarsi che il ventilatore sia posizionato su una superficie stabile per evitare che si ribalti.
- Non utilizzare il ventilatore nei pressi di una finestra aperta, le intemperie potrebbero provocare scosse elettriche.
- Solo per uso domestico.

2 Istruzioni per l'installazione

2.1 Nome dei componenti

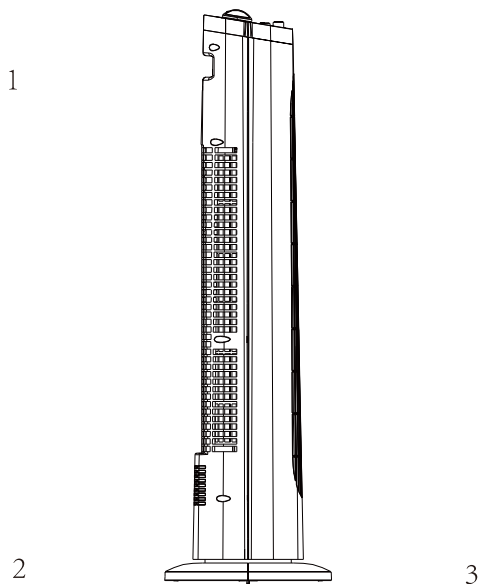

1. Corpo del ventilatore

2. Base A

3. Base B

2 Istruzioni per l'installazione

Installazione della base

Passaggio 1

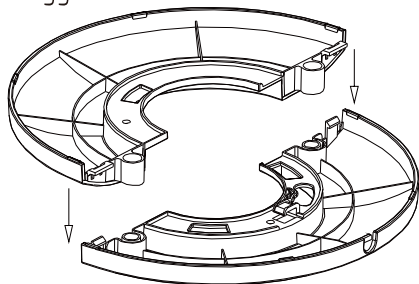

1. Unire le due metà della base. Consultare il passaggio 1.

Passaggio 2

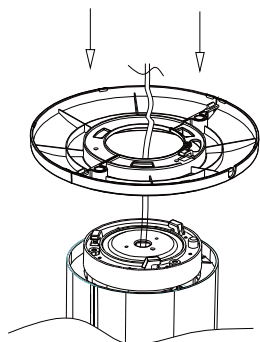

2. Posizionare la base sulla parte inferiore del ventilatore, inserire il cavo di alimentazione attraverso la base e assicurarsi che i fermi sulla colonna siano allineati con i fori sulla base. Consultare il passaggio 2.

Passaggio 3

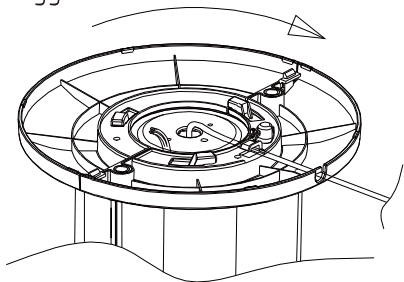

3. Quindi ruotare in senso orario la base finché non si blocca. Infine far passare il cavo di alimentazione nella guida sulla parte inferiore della base premendo delicatamente il filo nei morsetti. Consultare il passaggio 3.

3 Utilizzo

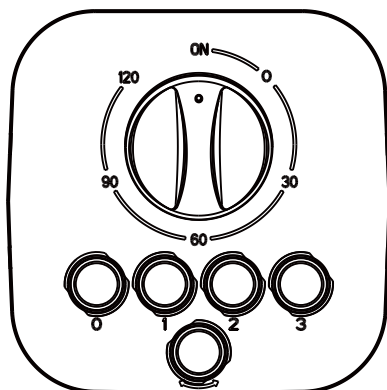

Controlli: Premere il pulsante di selezione per selezionare la velocità.

"1" per bassa

"2" per media

"3" per alta

"0" per spegnere

Oscillazione: Premere il pulsante "↔" sulla parte superiore del ventilatore per avviare l'oscillazione. Premerlo di nuovo per interromperla.

Timer: Timer di 2 ore

Per l'uso del timer, ruotare il controllo del timer in senso orario per usare la ventola per il tempo selezionato.



Suggerimenti

Non ruotare il timer in senso antiorario da "120" a "ON" (ACCENSIONE).

4 Istruzioni supplementari

4.1 Istruzioni per la manutenzione

Il ventilatore non richiede particolari attenzioni. Non tentare di riparare il ventilatore da soli. Rivolgersi a personale qualificato se occorre eseguire delle riparazioni.

1. Prima di eseguire pulizia e assemblaggio, il ventilatore deve essere scollegato dall'alimentazione.
2. Per garantire l'adeguata circolazione dell'aria nei pressi del motore, rimuovere la polvere dalle prese d'aria sul retro del motore. Non smontare il ventilatore per rimuovere la polvere.
3. Pulire le parti esterne con un panno morbido imbevuto di detergente delicato.
4. Non utilizzare detersivi o solventi abrasivi per evitare di graffiare la superficie. Non utilizzare benzina o diluenti come detergente.
5. Non lasciare che acqua o altri liquidi penetrino nell'alloggiamento del motore o nelle parti interne.

4.2 Pulizia

1. Accertarsi di scollegare l'alimentazione prima di eseguire la pulizia.
2. Pulire le parti in plastica con un panno morbido leggermente inumidito con del sapone delicato. Rimuovere accuratamente i residui di sapone con un panno asciutto.

4.3 Dati tecnici

Alimentazione: 220- 240 V~, 50 Hz

Specifiche tecniche e design sono soggetti a modifiche senza preavviso.

5 Smaltimento



Nota: Non smaltire apparecchiature elettriche come rifiuti indifferenziati, ma servirsi di impianti per la raccolta appositi. Contattare l'ente territoriale preposto per informazioni concernenti i sistemi di raccolta disponibili. Se le apparecchiature elettriche sono smaltite in discariche, le sostanze pericolose possono penetrare nelle falde acquifere ed entrare nella catena alimentare, diventando un pericolo per la salute.



Questo apparecchio è conforme alla Direttiva UE WEEE (2012/19/EU). Questo apparecchio riporta il simbolo di classificazione per i rifiuti delle apparecchiature elettriche ed elettroniche (WEEE). Questo simbolo indica che questo prodotto non deve essere smaltito con altri rifiuti domestici al termine della sua vita utile. Il dispositivo usato deve essere portato a un punto di raccolta ufficiale per il riciclaggio di dispositivi elettrici ed elettronici. Per individuare questi punti di raccolta, contattare le proprie autorità locali oppure il rivenditore presso cui è stato acquistato il prodotto. Ciascuna famiglia ha un ruolo importante nel recupero e riciclaggio di vecchi apparecchi. Lo smaltimento appropriato degli apparecchi usati aiuta a prevenire potenziali conseguenze negative per l'ambiente e la salute umana.

Informazioni			
Descrizione	Simbolo	Valore	Unità
Portata d'aria massima	F	10	m ³ /min
Alimentazione ventilatore	P	35	W
Valore d'esercizio	SV	0,29	(m ³ /min)/W
Consumo energetico in standby	P _{SB}	0	W
Livello di potenza sonora del ventilatore	L _{WA}	62	dB(A)
Velocità massima dell'aria	C	5,0	metri/sec
Norma di misura per il valore di servizio	IEC 60879:1986+ (corré.1992)		
Dettagli di contatto per ulteriori informazioni	Arcelik: Arcelik AS. Sutluce. Karaagac Cd. 2-6, 34445 Beyoglu Istanbul Turkey		

Importer in Poland Importer w Polsce Beko S.A. ul. Puławska 366 02-819 Warszawa www.beko.pl	Importer in Czech Republic Dovožce do České republiky BEKO S.A., organizační složka Bucharova 1423/6, Praha 13 – Nové Butovice, 158 00 www.bekocr.cz	Importer in Slovakia Dovožca na Slovensko BEKO Slovakia s.r.o. Suché myto 1 811 03 Bratislava www.bekosk.sk	Importer in Estonia Importija Eesti Beko S.A. Tänav Puulawska 366 02-819 Varssavi (Poola)	Importer in Norway Karenslyst Allé 2 0278 Oslo
Importer in UK BEKO Plc, Beko House, 1 Greenhill Crescent, Watford, Herts, WD18 8QU	Importer in Germany Beko Grundig Deutschland GmbH Thomas-Edison-Platz 3 63263 Neu-Isenburg	KSA Importer HUSSEIN & ALHASSAN G. SHAKER BROS. FOR MODERN TRADING CO. LTD. Hail Street – Al Bughdadiyah Al Gharbeyah District Shaker Building – 6th floor (+966)126454227	Importer in France BEKO France / Immeuble Stadium, 266, Avenue du Président Wilson 93218 La Plaine Saint-Denis Cedex	
Importer in Spain BEKO ELECTRONICS ESPANA S.L.C/ Provenza, 388. 3a planta, 08025 Barcelona	Importer for Malta ETV LTD 119/120 Archbishop Street VALLETTA MALTA	Importer in Latvia Importētāja Latvijā Beko S.A. Ielas Puļawska 366 02-819 Varšava (Polija)	Importer in Switzerland Secomp AG Grindelstrasse 6 CH-8303 Bassersdorf Switzerland	Importer in Lithuania Importuotojas Lietuvoje Beko S.A. Gatvė Puļawska 366 02-819 Varšuva (Lenkija)
Importer in Austria ELEKTRA BREGENZ AG PFARRGASSE 77 VIENNA post code 1230	Importer in Sweden Grundig Nordic AB Klarabergsviadukten SE-11164 Stockholm	Importer in Hungary Hauser Magyarorszag imited Baross utca 89 PC: 2040 Budaörs / Hungary	Importer in Slovenia BIG BANG, D.O.O. Šmartinska cesta 152 PC: 1000 Ljubljana/Slovenia	Importer in Italy BEKO ITALY SRL Viale Del Ghisallo, 201/20151 Milano (MI)
Importer in Romania ARCTIC S.A. Str. 13 Decembrie, nr.210 Găești, 135200, România www.arctic.ro	Importer in Belgium Asogem NV/SA Schalihenoevedreef 26 2800 Mechelen Belgium	Importer in Greece PAR. SEITANIDIS S.A. Polistilo, P.O. Box:1402 Kavala, 64003	Importer in Bulgaria VIDEOLUX Ltd. 265, Okolovrasten pat Str. Mladost 4, 1766 Sofia, Bulgaria	Importer in Croatia E PLUS doo ZA Unamrju / GOSPODARSKA 16c / 10225 GORNJI STUPNIK / ZAGREP
Importer in Russia Импортёр на территории РФ: ООО «БЕКО», РФ, 601021, Владимирская обл., Киржачский р-н Муниципальное образование сельское поселение Першинское, дер. Федоровское, ул. Сельская, д. 49 Бесплатная линия сервисного обслуживания и информационной поддержки по установке и эксплуатации (только для звонков по России) 8-800-200-23-56 Изготовитель: Arcelik A.Ş. Турция, Karaağaç Caddesi No: 2-6 Istanbul 34445 Sutluce, Istanbul				
Виробник: "Arçelik A.S." Karaağaç Caddesi No: 2-6 Sütlüce, 34445, Turkey/ "Arçelik A.S.", м. Стамбул, Сютлюдже, вул. Караагач № 2-6, 34445, Туреччина, Термін служби 10 років Імпортер на території України: ТОВ «Бекo Україна», адреса: 03150, м. Київ, вул. Антоновича, буд. 72 тел/факс.: 0-800-500-4-3-2				
Manufactured by Arcelik A.S. Karaagac Cd. No:2-6 34445 Sutluce, Beyoglu, Istanbul, Turkey SDA-HVAC-11-20-05				







Lesen Sie zunächst diese Bedienungsanleitung durch!

Sehr geehrte Kundinnen und Kunden,

vielen Dank, dass Sie sich für ein Produkt von Beko entschieden haben. Wir hoffen, dass Ihnen dieses Produkt optimalen Nutzen bringen wird. Dieses hochwertige Produkt wurde mit modernster Technologie hergestellt. Lesen Sie die gesamte Bedienungsanleitung und alle anderen Begleitdokumente sorgfältig durch, bevor Sie das Produkt verwenden, und heben Sie alle Dokumente gut auf. Falls Sie das Produkt an Dritte weitergeben, überreichen Sie auch diese Bedienungsanleitung. Beachten Sie alle Warnungen und Informationen in dieser Bedienungsanleitung.

Erläuterung der Symbole

Die folgenden Symbole finden Sie im Verlauf der Bedienungsanleitung:

	Wichtige Information oder nützliche Hinweise für den Gebrauch.		Warnung vor Brandgefahren.
	Warnung vor Situationen, die eine Gefahr für Leben und Sacheigentum darstellen.		Warnung vor heißen Oberflächen.
	Warnung bzgl. Handlungen, die niemals durchgeführt werden dürfen.		Nicht abdecken.
	Warnung vor Stromschlägen.		



Dieses Produkt wurde in einer umweltgerechten, modernen Produktionsstätte hergestellt.

INHALTSVERZEICHNIS

1 Sicherheitshinweise	36
2 Installationsanleitungen	39
2.1 Teileübersicht.....	39
3 Bedienung	41
4 Sonstiges	42
4.1 Wartung.....	42
4.2 Reinigung	42
4.3 Technische Daten.....	42
5 Entsorgung	43

1 Sicherheitshinweise

Warnung

Lesen Sie die Hinweise für einen sicheren Gebrauch sowie alle Anleitungen sorgfältig durch.

- Ein beschädigtes Netzkabel muss vom Hersteller, dessen Kundendienst oder einer ähnlich qualifizierten Fachkraft ersetzt werden, um Gefahrensituationen zu vermeiden.
- Nur für den Innengebrauch.
- Um Stromschläge zu vermeiden, dürfen weder das Produkt noch das Kabel oder der Stecker in Wasser oder andere Flüssigkeiten eingetaucht werden.
- Dieses Gerät ist geeignet für den Gebrauch durch Kinder ab 8 Jahren und Personen mit eingeschränkten körperlichen, sensorischen oder geistigen Fähigkeiten, oder ohne Erfahrung und Wissen, sofern sie beaufsichtigt und über den sicheren Gebrauch des Geräts angeleitet werden und die damit einhergehenden Gefahren verstehen. Kinder dürfen nicht mit dem Gerät spielen. Reinigungsarbeiten und Benutzerwartungen dürfen von Kindern nur unter Aufsicht durchgeführt werden. Kinder sollten beaufsichtigt werden, um sicherzustellen, dass sie nicht mit dem Gerät spielen.
- Trennen Sie das Gerät während des Nichtgebrauchs und vor der Reinigung vom Netzstrom.
- Nach der Installation des Geräts darf die Abdeckung des Ventilatorflügels nicht mehr abgenommen werden.
- Ordnungsgemäße Entsorgung des Produkts.

1 Sicherheitshinweise



- Diese Markierung weist darauf hin, dass das Produkt innerhalb der EU nicht über den Hausmüll entsorgt werden darf. Um Umwelt- und Gesundheitsschäden durch unkontrollierte Müllentsorgung zu vermeiden, recyceln Sie verantwortungsbewusst, um die nachhaltige Wiederverwertung von Rohstoffen zu unterstützen. Geben Sie Ihr gebrauchtes Gerät an entsprechenden Sammelstellen ab oder wenden Sie sich an Ihren Händler, bei dem Sie das Produkt erworben haben. Dort kann das Produkt für das umweltgerechte Recycling entgegengenommen werden.
- Dieses Gerät ist nicht für die Verwendung durch Personen (einschließlich Kinder) mit eingeschränkten körperlichen, sensorischen oder psychischen Fähigkeiten und ohne Erfahrung oder Vorwissen geeignet, außer wenn eine angemessene Aufsicht oder ausführliche Anleitung zur Benutzung des Gerätes durch eine verantwortliche Person sichergestellt ist.
- Wenn in den Anweisungen angegeben ist, dass die Schutzvorrichtung zu Reinigungszwecken entfernt werden muss, müssen die Anweisungen folgende Punkte enthalten: Stellen Sie sicher, dass der Ventilator ausgeschaltet und vom Versorgungsnetz getrennt ist, bevor Sie die Schutzvorrichtung entfernen.

1 Sicherheitshinweise

Anleitungen für den sicheren Gebrauch

- Stecken Sie während des Gebrauchs weder Finger noch Stifte oder andere Gegenstände durch die Schutzabdeckung.
- Trennen Sie den Ventilator vom Netzstrom, bevor Sie diesen an einen anderen Ort stellen.
- Stellen Sie den Ventilator während des Gebrauchs auf einen stabilen Untergrund, damit er nicht umkippen kann.
- Verwenden Sie das Gerät nicht in Fenstern; Regen kann Stromschläge verursachen.
- Nur für den Heimgebrauch.

2 Installationsanleitungen

2.1 Teileübersicht

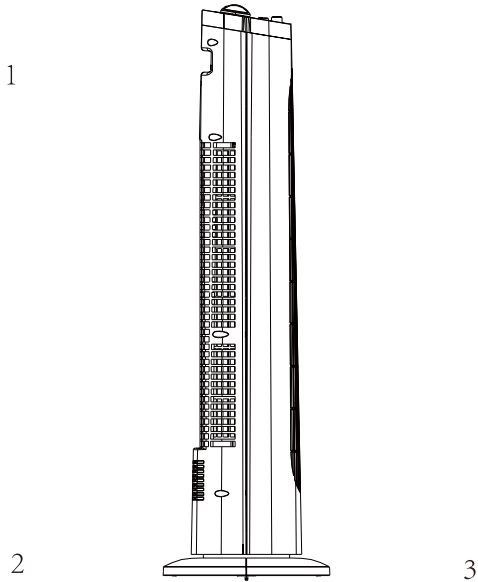

1. Ventilatorgehäuse

2. Sockel A

3. Sockel B

2 Installationsanleitungen

Den Sockel montieren

Schritt 1

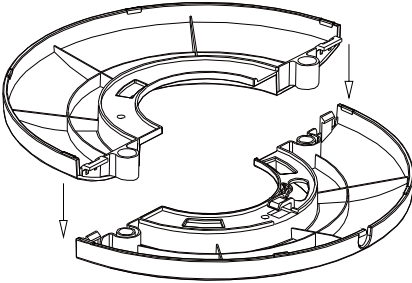

1. Setzen Sie die beiden Hälften des Sockels zusammen. Siehe Schritt 1.

Schritt 2

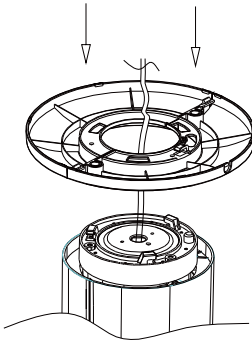

2. Positionieren Sie den Sockel auf der Unterseite des Lüfters, führen Sie das Netzkabel durch den Sockel und stellen Sie sicher, dass die Klammern am Lüftergehäuse des Turms mit den Öffnungen am Sockel ausgerichtet sind. Siehe Schritt 2.

Schritt 3

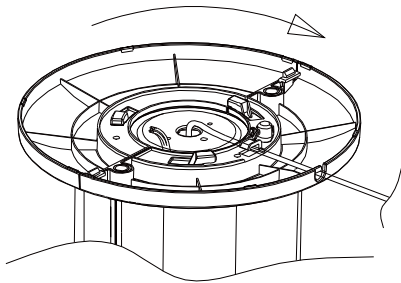

3. Drehen Sie dann den Sockel im Uhrzeigersinn, bis er verriegelt ist. Fädeln Sie zum Schluss das Netzkabel in die Führung an der Unterseite des Sockels ein, indem Sie es vorsichtig in die Klemmen drücken. Siehe Schritt 3.

3 Bedienung

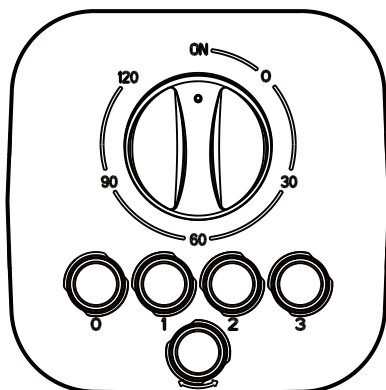

Steuerungen: Drücken Sie die entsprechende Taste, um die gewünschte Ventilatorgeschwindigkeit auszuwählen.

„1“ für low (niedrig),

„2“ für medium (mittel),

„3“ für high (hoch),

„0“ für power off (ausgeschaltet)

Oszillation: Drücken Sie oben auf dem Ventilator die Taste „“, um die Oszillation zu starten. Erneut drücken, um zu stoppen.

Timer: 2-Stunden-Timer

Für den Timerbetrieb drehen Sie die Timersteuerung im Uhrzeigersinn, um den Ventilator für die gewählte Dauer laufenzulassen.



Tipps

Drehen Sie den Timer nicht entgegen dem Uhrzeigersinn von der Position „120“ zur Position „ON“ (EIN).

4 Sonstiges

4.1 Wartung

Der Ventilator muss nur geringfügig gewartet werden. Reparieren Sie den Ventilator nicht eigenständig. Sofern erforderlich, lassen Sie das Gerät nur von qualifizierten Wartungstechnikern reparieren.

1. Trennen Sie das Gerät vor der Reinigung und Installation vom Netzstrom.
2. Um eine ordnungsgemäße Belüftung des Motors zu gewährleisten, müssen die Belüftungsschlitze an der Rückseite des Motors sauber gehalten werden. Der Ventilator darf für die Beseitigung von Schmutz nicht demontiert werden.
3. Wischen Sie die äußeren Teile mit einem weichen Lappen und etwas mildem Reinigungsmittel vorsichtig ab.
4. Verwenden Sie keine Scheuermittel oder Lösungsmittel, da anderenfalls die Oberfläche beschädigt werden könnte. Verwenden Sie keine der nachfolgenden Reinigungsmittel: Benzin, Verdünner.
5. Lassen Sie weder Wasser noch andere Flüssigkeiten in das Motorgehäuse oder die inneren Teile eindringen.

4.2 Reinigung

1. Trennen Sie das Gerät vor der Reinigung vom Netzstrom.
2. Reinigen Sie Kunststoffteile mit einem weichen Lappen, den Sie mit etwas Spülmittel anfeuchten. Entfernen Sie Spülmittelrückstände mit einem trockenen Lappen.

4.3 Technische Daten

Stromversorgung: 220 - 240 V~, 50 Hz

Änderungen der technischen Daten und am Design vorbehalten.

5 Entsorgung



Hinweis: Entsorgen Sie elektrische Geräte nicht über den normalen Hausmüll, sondern getrennt an entsprechenden Sammelstellen. Wenden Sie sich an Ihre Behörde vor Ort, um nähere Informationen über verfügbare Sammelstellen zu erhalten. Falls elektrische Geräte auf Müllhalden oder Deponien entsorgt werden, können gefährliche Substanzen in das Grundwasser und in die Nahrungskette gelangen und dadurch Risiken für die Gesundheit und das Wohlbefinden verursachen.



Dieses Produkt erfüllt die Vorgaben der EU-WEEE-Direktive (2012/19/EU). Das Produkt wurde mit einem Klassifizierungssymbol für elektrische und elektronische Altgeräte (WEEE) gekennzeichnet. Dieses Symbol zeigt an, dass dieses Gerät am Ende seiner Einsatzzeit nicht mit anderem Hausmüll entsorgt werden darf. Altgeräte müssen an offizielle Sammelstellen zum Recycling elektrischer und elektronischer Geräte abgegeben werden. Nähere Angaben zu diesen Sammelstellen erhalten Sie von Ihrer Stadtverwaltung oder dem Händler, bei dem Sie das Gerät erworben haben. Der Beitrag jedes Haushalts zum Umweltschutz ist wichtig. Eine angemessene Entsorgung von Altgeräten hilft bei der Verhinderung negativer Auswirkungen auf Umwelt und menschliche Gesundheit.

Information

Bezeichnung	Symbol	Wert	Einheit
Maximales Luftvolumen	F	10	m ³ /Min
Ventilatoraufnahmeleistung	P	35	W
Servicewert	SV	0,29	(m ³ /Min)/W
Standby-Energieverbrauch	P _{SB}	0	W
Geräuschpegel	L _{WA}	62	dB(A)
Maximale Luftgeschwindigkeit	C	5,0	Meter/Sek.
Bewertungsstandard für Servicewert	IEC 60879:1986+ (corr. 1992)		
Kontaktdaten für die Bereitstellung weiterer Informationen	Arcelik: Arcelik AS. Sutluce. Karaagac Cd. 2-6, 34445 Beyoglu Istanbul Türkei		

Importer in Poland Importer w Polsce Beko S.A. ul. Puławska 366 02-819 Warszawa www.beko.pl	Importer in Czech Republic Dovožce do České republiky BEKO S.A., organizační složka Bucharova 1423/6, Praha 13 – Nové Butovice, 158 00 www.bekocr.cz	Importer in Slovakia Dovožca na Slovensko BEKO Slovakia s.r.o. Suché myto 1 811 03 Bratislava www.bekosk.sk	Importer in Estonia Importija Eesti Beko S.A. Tänav Puulawska 366 02-819 Varssavi (Poola)	Importer in Norway Karenslyst Allé 2 0278 Oslo
Importer in UK BEKO Plc, Beko House, 1 Greenhill Crescent, Watford, Herts, WD18 8QU	Importer in Germany Beko Grundig Deutschland GmbH Thomas-Edison-Platz 3 63263 Neu-Isenburg	KSA Importer HUSSEIN & ALHASSAN G. SHAKER BROS. FOR MODERN TRADING CO. LTD. Hail Street – Al Bughdadiyah Al Gharbeyah District Shaker Building – 6th floor (+966)126454227	Importer in France BEKO France / Immeuble Stadium, 266, Avenue du Président Wilson 93218 La Plaine Saint-Denis Cedex	
Importer in Spain BEKO ELECTRONICS ESPANA S.L.C/ Provenza, 388. 3a planta, 08025 Barcelona	Importer for Malta ETV LTD 119/120 Archbishop Street VALLETTA MALTA	Importer in Latvia Importētāja Latvijā Beko S.A. Ielas Puļawska 366 02-819 Varšava (Polija)	Importer in Switzerland Secomp AG Grindelstrasse 6 CH-8303 Bassersdorf Switzerland	Importer in Lithuania Importuotojas Lietuvoje Beko S.A. Gatvė Puļawska 366 02-819 Varšuva (Lenkija)
Importer in Austria ELEKTRA BREGENZ AG PFARRGASSE 77 VIENNA post code 1230	Importer in Sweden Grundig Nordic AB Klarabergsviadukten SE-11164 Stockholm	Importer in Hungary Hauser Magyarorszag imited Baross utca 89 PC: 2040 Budaörs / Hungary	Importer in Slovenia BIG BANG, D.O.O. Šmartinska cesta 152 PC: 1000 Ljubljana/Slovenia	Importer in Italy BEKO ITALY SRL Viale Del Ghisallo, 201/20151 Milano (MI)
Importer in Romania ARCTIC S.A. Str. 13 Decembrie, nr.210 Găești, 135200, România www.arctic.ro	Importer in Belgium Asogem NV/SA Schalihenoevedreef 26 2800 Mechelen Belgium	Importer in Greece PAR. SEITANIDIS S.A. Polistilo, P.O. Box:1402 Kavala, 64003	Importer in Bulgaria VIDEOLUX Ltd. 265, Okolovrasten pat Str. Mladost 4, 1766 Sofia, Bulgaria	Importer in Croatia E PLUS doo ZA Unamrju / GOSPODARSKA 16c / 10225 GORNJI STUPNIK / ZAGREP
Importer in Russia Импортёр на территории РФ: ООО «БЕКО», РФ, 601021, Владимирская обл., Киржачский р-н Муниципальное образование сельское поселение Першинское, дер. Федоровское, ул. Сельская, д. 49 Бесплатная линия сервисного обслуживания и информационной поддержки по установке и эксплуатации (только для звонков по России) 8-800-200-23-56 Изготовитель: Arcelik A.Ş. Турция, Karaağaç Caddesi No: 2-6 Istanbul 34445 Sutluce, Istanbul				
Виробник: "Arçelik A.S." Karaağaç Caddesi No: 2-6 Sütlüce, 34445, Turkey/ "Arçelik A.S.", м. Стамбул, Сютлюдже, вул. Караагач № 2-6, 34445, Туреччина, Термін служби 10 років Імпортер на території України: ТОВ «Бекo Україна», адреса: 03150, м. Київ, вул. Антоновича, буд. 72 тел/факс.: 0-800-500-4-3-2				
Manufactured by Arcelik A.S. Karaagac Cd. No:2-6 34445 Sutluce, Beyoglu, Istanbul, Turkey SDA-HVAC-11-20-05				

Veillez d'abord lire ce manuel d'utilisation.

Cher client,

Nous vous remercions d'avoir acheté un produit Beko. Nous espérons que ce produit vous apportera entière satisfaction. Tous nos produits sont fabriqués dans une usine moderne et font l'objet d'un contrôle de qualité minutieux. À cet effet, veuillez lire en intégralité le présent manuel avant d'utiliser cet appareil et conservez-le soigneusement pour une utilisation ultérieure. Si vous remettez le produit à un autre utilisateur, remettez-le-lui avec le manuel d'utilisation. Veuillez à bien respecter les consignes et les instructions figurant dans le manuel d'utilisation.

Signification des pictogrammes

Vous trouverez les pictogrammes suivants dans ce manuel d'utilisation :



Informations importantes et conseils utiles concernant l'utilisation de l'appareil.



Risque d'incendie.



Avertissement à propos des situations dangereuses qui pourraient entraîner des blessures ou des dégâts matériels.



Attention ! Surfaces chaudes !



Avertissement relatif aux actions à ne jamais effectuer.



Ne pas couvrir.



Risque d'électrocution.



Ce produit a été fabriqué dans le respect de l'environnement et dans des installations modernes.

Ce produit est conforme à la réglementation DEEE (Déchets d'équipements électriques et électroniques) en vigueur.



Ce produit ne contient pas de PCB.

TABLES DES MATIÈRES

1	Consignes de sécurité	47
2	Instructions d'installation	50
2.1	Schéma des composants.....	50
3	Fonctionnement	52
4	Autres instructions	53
4.1	Consignes d'entretien.....	53
4.2	Nettoyage.....	53
4.3	Données techniques.....	53
5	Mise au rebut	54

1 Consignes de sécurité

Avertissement

Veuillez lire attentivement les instructions et consignes de sécurité.

- Si le cordon d'alimentation est endommagé, il doit être remplacé par le constructeur, une personne mandatée par le service de réparation ou toute autre personne qualifiée afin d'éviter tout danger.
- Ce produit est conçu pour un usage en intérieur uniquement.
- Ne jamais immerger l'unité, le cordon ou la fiche dans de l'eau ni dans tout autre liquide afin d'éviter tout risque d'électrocution.
- Cet appareil peut être utilisé par des enfants âgés de 8 ans au moins ainsi que par des personnes ayant des capacités corporelles, sensorielles ou mentales restreintes ou manquant de connaissances ou d'expériences si celles-ci sont surveillées ou ont été informées quant à l'utilisation sûre de l'appareil et des risques existants. Surveillez les enfants afin qu'ils ne jouent pas avec l'appareil. Le nettoyage et la maintenance ne doivent pas être réalisés par des enfants laissés sans surveillance. Il faut surveiller les enfants afin que ces derniers ne jouent pas avec l'appareil.
- Débranchez l'appareil de la prise électrique lorsque vous ne l'utilisez pas ou avant de le nettoyer.
- Une fois le ventilateur monté, la grille de protection de l'hélice ne doit plus être enlevée.
- Mise au rebut adéquate de cet appareil.

1 Consignes de sécurité



- Ce symbole indique que ce produit ne doit pas être jeté avec les déchets ménagers, et ce dans toute l'Union européenne. Afin de prévenir tout danger pour l'environnement ou la santé humaine provenant d'une élimination incontrôlée des déchets, recyclez cet appareil de façon responsable afin de promouvoir la réutilisation durable des ressources matérielles. Pour recycler votre appareil usagé, veuillez utiliser les systèmes de collecte et de récupération ou contactez le détaillant auprès duquel le produit a été acheté. Le magasin peut reprendre votre produit en vue de son recyclage en toute sécurité.
- Cet appareil n'est pas prévu pour être utilisé par des personnes (enfants compris) ayant des capacités corporelles, sensorielles ou mentales restreintes ou manquant de connaissances ou d'expériences si ces dernières ne sont pas surveillées ou n'ont pas été informées quant à l'utilisation de l'appareil par une personne responsable de la sécurité.
- Si les instructions précisent qu'un dispositif de protection doit être retiré pour le nettoyage, elles doivent indiquer la teneur de ce qui suit :
Assurez-vous que le ventilateur est éteint et débranché de l'alimentation secteur avant de retirer le film plastique de protection.

1 Consignes de sécurité

Consignes de sécurité

- Ne tentez jamais d'introduire vos doigts, un crayon ou tout autre objet à travers la grille lorsque le ventilateur est en marche.
- Débranchez le ventilateur lorsque vous le déplacez d'un endroit à un autre.
- Assurez-vous que le ventilateur est placé sur une surface stable lorsqu'il est en marche, afin d'éviter qu'il ne se renverse.
- Ne mettez pas le ventilateur en marche à proximité d'une fenêtre, car la pluie pourrait générer un danger électrique en s'infiltrant dans l'appareil.
- Cet appareil est uniquement conçu pour un usage domestique.

2 Instructions d'installation

Installer la base

Étape 1

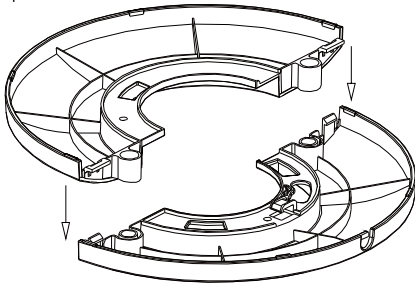

1. Assemblez les deux parties de la base. Voir étape 1.

Étape 2

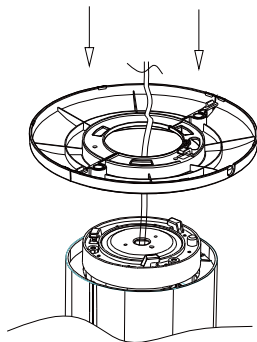

2. Placez la base au bas du ventilateur, faites passer le cordon d'alimentation par la base. Assurez-vous que les attaches du corps du ventilateur-colonne soient alignées avec les trous de la base. Voir étape 2.

Étape 3

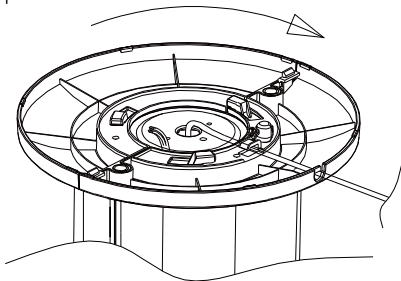

3. Faites ensuite tourner la base dans le sens horaire jusqu'à ce qu'elle se verrouille en place. Enfin, faites passer le cordon d'alimentation dans la rainure au bas de la base en insérant le câble dans le système de serrage. Voir étape 3.

2 Instructions d'installation

2.1 Schéma des composants

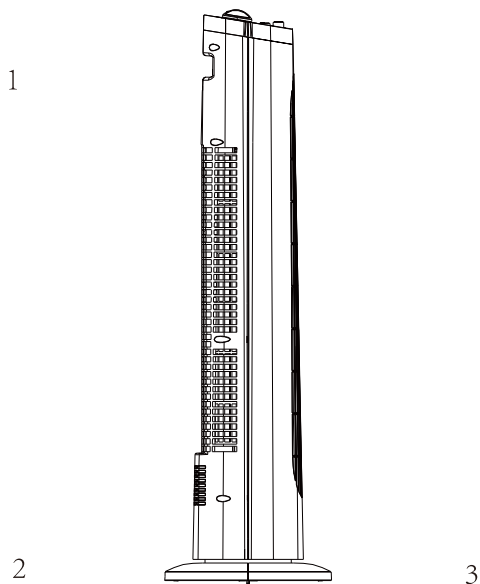

1. Corps du ventilateur

2. Base A

3. Base B

3 Fonctionnement

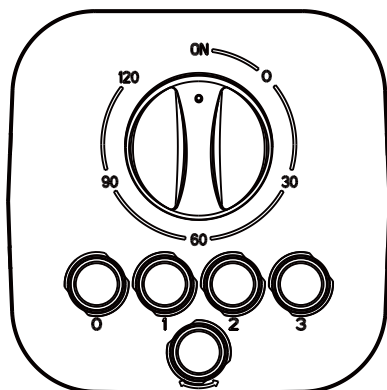

Commandes : appuyez sur le sélecteur pour choisir la vitesse désirée.

- « 1 » pour lente,
- « 2 » pour intermédiaire,
- « 3 » pour rapide,
- « 0 » pour arrêt.

Oscillation : appuyez sur le bouton «  » au sommet du ventilateur pour faire osciller le ventilateur (mouvement de rotation horizontal). Appuyez à nouveau sur le bouton pour l'arrêt.

Minuteur : durée maximale de 2 heures.

Pour activer le minuteur, tournez la molette dans le sens horaire : le ventilateur fonctionnera pour toute la durée sélectionnée.



Recommandations

Ne tournez pas la molette du minuteur dans le sens inverse des aiguilles d'une montre : de « 120 » à « ON » (Marche).

4 Autres instructions

4.1 Consignes d'entretien

Ce ventilateur exige peu d'entretien. N'essayez pas de le réparer par vous-même. Si une réparation est nécessaire, veuillez contacter un technicien qualifié.

1. Débranchez le ventilateur avant son nettoyage ou son montage.
2. Empêchez la poussière de s'accumuler à l'arrière de l'appareil, afin de garantir une bonne circulation de l'air vers le moteur. Ne démontez pas le ventilateur pour éliminer la poussière.
3. Veuillez essuyer les parties extérieures à l'aide d'un chiffon non pelucheux imprégné de détergent doux.
4. N'utilisez ni solvant ni détergent abrasif, car il pourrait rayer la surface de l'appareil. N'utilisez aucun des produits suivants pour nettoyer l'appareil : essence, dissolvant.
5. Ne laissez pas d'eau ou tout autre liquide s'infiltrer dans le boîtier du moteur ou mouiller les composants intérieurs.

4.2 Nettoyage

1. Avant de le nettoyer, assurez-vous que l'appareil est bien débranché de sa source d'alimentation électrique.
2. Les composants en plastique doivent être nettoyés à l'aide d'un chiffon non pelucheux imprégné de savon doux. Retirez soigneusement tous les résidus de savon à l'aide d'un chiffon sec.

4.3 Données techniques

Alimentation électrique : 220 à 240 V~, 50 Hz

Sous réserve de modifications techniques ou d'aspect extérieur du produit.

5 Mise au rebut



Remarque : ne jetez pas les appareils électriques avec les déchets ménagers non triés. Déposez-les dans des infrastructures dédiées à la collecte sélective. Contactez votre administration locale pour obtenir des renseignements concernant les systèmes de collecte disponibles. Lorsque des appareils électriques sont jetés dans des décharges, des substances dangereuses peuvent s'infiltrer jusqu'aux eaux souterraines et contaminer la chaîne alimentaire, constituant ainsi un risque pour votre santé et votre bien-être.



Ce produit est conforme à la directive DEEE (2012/19/UE) de l'Union européenne). Ce produit porte un symbole de classification pour la mise au rebut des équipements électriques et électroniques (DEEE). Ce symbole indique que ce produit ne doit pas être jeté avec les déchets ménagers à la fin de sa vie utile. Les appareils usagés doivent être retournés au point de collecte officiel destiné au recyclage des appareils électriques et électroniques. Pour trouver ces systèmes de collecte, veuillez contacter les autorités locales ou le détaillant auprès duquel vous avez acheté le produit. Chaque ménage joue un rôle important dans la récupération et le recyclage des appareils ménagers usagés. L'élimination appropriée des appareils usagés aide à prévenir les conséquences négatives potentielles pour l'environnement et la santé humaine.

Informations			
Description	Symbole	Valeur	Unité
Débit d'air maximal du ventilateur	F	10	m ³ /min
Puissance du ventilateur	P	35	W
Valeur de service	SV	0,29	(m ³ /min)/W
Consommation électrique en veille	P _{SB}	0	W
Niveau sonore du ventilateur	L _{WA}	62	dB(A)
Vitesse maximale de l'air	C	5,0	mètres/s
Norme de mesure de la valeur de service	IEC 60879 ; 1986 + (corr. 1992)		
Coordonnées de contact pour tout complément d'information	Arcelik : Arcelik AS, Sutluce, Karaağaç Cd. 2-6, 34445 Beyoglu Istanbul Turquie		

Importer in Poland Importer w Polsce Beko S.A. ul. Puławska 366 02-819 Warszawa www.beko.pl	Importer in Czech Republic Dovožce do České republiky BEKO S.A., organizační složka Bucharova 1423/6, Praha 13 – Nové Butovice, 158 00 www.bekocr.cz	Importer in Slovakia Dovožca na Slovensko BEKO Slovakia s.r.o. Suché myto 1 811 03 Bratislava www.bekosk.sk	Importer in Estonia Importija Eesti Beko S.A. Tänav Puulawska 366 02-819 Varssavi (Poola)	Importer in Norway Karenslyst Allé 2 0278 Oslo
Importer in UK BEKO Plc, Beko House, 1 Greenhill Crescent, Watford, Herts, WD18 8QU	Importer in Germany Beko Grundig Deutschland GmbH Thomas-Edison-Platz 3 63263 Neu-Isenburg	KSA Importer HUSSEIN & ALHASSAN G. SHAKER BROS. FOR MODERN TRADING CO. LTD. Hail Street – Al Bughdadiyah Al Gharbeyah District Shaker Building – 6th floor (+966)126454227	Importer in France BEKO France / Immeuble Stadium, 266, Avenue du Président Wilson 93218 La Plaine Saint-Denis Cedex	
Importer in Spain BEKO ELECTRONICS ESPANA S.L.C/ Provenza, 388. 3a planta, 08025 Barcelona	Importer for Malta ETV LTD 119/120 Archbishop Street VALLETTA MALTA	Importer in Latvia Importētāja Latvijā Beko S.A. Ielas Puļawska 366 02-819 Varšava (Polija)	Importer in Switzerland Secomp AG Grindelstrasse 6 CH-8303 Bassersdorf Switzerland	Importer in Lithuania Importuotojas Lietuvoje Beko S.A. Gatvė Puļawska 366 02-819 Varšuva (Lenkija)
Importer in Austria ELEKTRA BREGENZ AG PFARRGASSE 77 VIENNA post code 1230	Importer in Sweden Grundig Nordic AB Klarabergsviadukten SE-11164 Stockholm	Importer in Hungary Hauser Magyarorszag imited Baross utca 89 PC: 2040 Budaörs / Hungary	Importer in Slovenia BIG BANG, D.O.O. Šmartinska cesta 152 PC: 1000 Ljubljana/Slovenia	Importer in Italy BEKO ITALY SRL Viale Del Ghisallo, 201/20151 Milano (MI)
Importer in Romania ARCTIC S.A. Str. 13 Decembrie, nr.210 Găești, 135200, România www.arctic.ro	Importer in Belgium Asogem NV/SA Schaliohoevedreef 26 2800 Mechelen Belgium	Importer in Greece PAR. SEITANIDIS S.A. Polistilo, P.O. Box:1402 Kavala, 64003	Importer in Bulgaria VIDEOLUX Ltd. 265, Okolovrasten pat Str. Mladost 4, 1766 Sofia, Bulgaria	Importer in Croatia E PLUS doo ZA Unamrju / GOSPODARSKA 16c / 10225 GORNJI STUPNIK / ZAGREP
Importer in Russia Импортёр на территории РФ: ООО «БЕКО», РФ, 601021, Владимирская обл., Киржачский р-н Муниципальное образование сельское поселение Першинское, дер. Федоровское, ул. Сельская, д. 49 Бесплатная линия сервисного обслуживания и информационной поддержки по установке и эксплуатации (только для звонков по России) 8-800-200-23-56 Изготовитель: Arcelik A.Ş. Турция, Karaağaç Caddesi No: 2-6 Istanbul 34445 Sutluce, Istanbul				
Виробник: "Arçelik A.S." Karaağaç Caddesi No: 2-6 Sütlüce, 34445, Turkey/ "Arçelik A.S.", м. Стамбул, Сютлюдже, вул. Караагач № 2-6, 34445, Туреччина, Термін служби 10 років Імпортер на території України: ТОВ «Бекo Україна», адреса: 03150, м. Київ, вул. Антоновича, буд. 72 тел/факс.: 0-800-500-4-3-2				
Manufactured by Arcelik A.S. Karaagac Cd. No:2-6 34445 Sutluce, Beyoglu, Istanbul, Turkey SDA-HVAC-11-20-05				

Lees deze gebruikershandleiding a.u.b. voorafgaand aan gebruik!

Geachte klant,

Hartelijk bedankt voor het aanschaffen van een Beko product. Dit kwaliteitsproduct is gefabriceerd volgens de nieuwste technologische standaarden en wij hopen dat u er optimaal van zult genieten. Lees daarom deze gebruikershandleiding en alle andere bijgesloten documentatie volledig door voordat u het product in gebruik neemt en bewaar de instructies als eventueel naslagwerk. Mocht u het product aan een ander geven, overhandig dan ook de gebruikershandleiding. Volg alle waarschuwingen en informatie in de gebruikershandleiding.

Betekenis van de symbolen

De volgende symbooltjes worden in de verschillende secties van deze handleiding gebruikt:

	Belangrijke informatie of nuttige tips m.b.t. het gebruik.
--	--

	Waarschuwing op gevaarlijke situaties m.b.t. fataal letsel en eigendommen.
--	--

	Waarschuwingen op acties die nooit mogen worden uitgevoerd.
--	---

	Waarschuwing voor elektrische schokken.
--	---

	Waarschuwing op levensgevaar.
---	-------------------------------

	Waarschuwing voor hete oppervlaktes.
---	--------------------------------------

	Dek het apparaat niet af.
--	---------------------------



Dit product is gefabriceerd in milieuvriendelijke, moderne faciliteiten

INHOUD

1 Veiligheidsinstructies	58
2 Installatie-instructies	61
2.1 Naam van de onderdelen	61
3 Bediening	63
4 Overige	64
4.1 Onderhoudsinstructies	64
4.2 Reinigen.....	64
4.3 Technische gegevens.....	64
5 Verwijdering	65

1 Veiligheidsinstructies

Waarschuwing

Lees de instructies voor een veilig gebruik goed door.

- Als het stroomsnoer is beschadigd, moet het worden vervangen door de fabrikant, de naverkoopservice of een vergelijkbaar gekwalificeerd persoon om gevaar te voorkomen.
- Alleen voor binnenhuis gebruik.
- Dompel het apparaat, snoer of de stekker niet onder water of een andere vloeistof om elektrische schokken te voorkomen.
- Dit apparaat mag worden gebruikt door kinderen vanaf 8 jaar en ouder en personen met beperkte fysieke, zintuiglijke of mentale mogelijkheden, of door personen met gebrek aan ervaring en kennis, mits zij onder toezicht staan of instructies hebben gekregen van een voor hun veiligheid verantwoordelijke persoon en de mogelijke gevaren volledig begrijpen. Kinderen mogen niet met het apparaat spelen. Het reinigen en gebruiksonderhoud mag niet worden uitgevoerd door kinderen zonder toezicht. Kinderen moeten onder toezicht om er zeker van te zijn dat ze niet spelen met het apparaat.
- Koppel het apparaat los van het stopcontact wanneer het apparaat niet in gebruik is en voor het reinigen.
- Wanneer de ventilator in elkaar is gezet, mag de zekering van het draaiende blad niet meer worden verwijderd.
- Correcte verwijdering van dit product.

1 Veiligheidsinstructies



- Deze markering geeft aan dat dit product niet mag worden weggegooid met ander huishoudelijk afval in de EU. Om mogelijke schade aan het milieu en de algemene gezondheid te voorkomen dient het apparaat via een goedgekeurd afvalstelsel behandeld en gerecycled te worden. U kunt het gebruikte apparaat terugsturen middels het inzamelingssysteem, of neem contact op met de verkoper waar u het product hebt aangeschaft. Zij kunnen dit product van u overnemen voor een milieuvriendelijke recycling.
- Dit apparaat mag niet worden gebruikt door personen (met inbegrip van kinderen) met beperkte fysieke, zintuiglijke of mentale mogelijkheden, of door personen met gebrek aan ervaring en kennis, tenzij deze onder toezicht staan of instructies hebben gekregen van een voor hun veiligheid verantwoordelijke persoon.
- Als de instructies aangeven dat de zekering moet worden verwijderd voor het reinigen, zal het volgende worden vermeld: Zorg dat de ventilator is losgekoppeld voor u de zekering verwijderd.

1 Veiligheidsinstructies

Instructies voor veilig gebruik

- Steek nooit uw vingers, pennen of andere objecten door het rooster wanneer de ventilator aanstaat.
- Koppel de ventilator los wanneer u deze naar een andere plek verplaatst.
- Zorg dat de ventilator op een stabiel oppervlak staat wanneer de ventilator in gebruik is om te voorkomen dat hij omvalt.
- Gebruik de ventilator niet bij een raam, regen kan elektrisch gevaar veroorzaken.
- Alleen voor huishoudelijk gebruik.

2 Installatie-instructies

2.1 Naam van de onderdelen

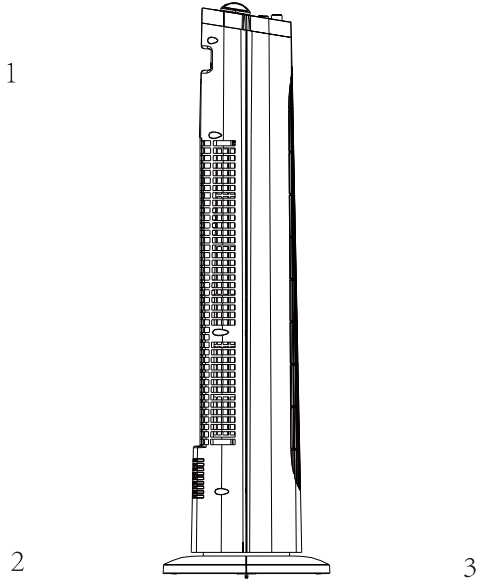

1. Ventilatorbehuizing

2. Basis A

3. Basis B

2 Installatie-instructies

De basis installeren

Stap 1

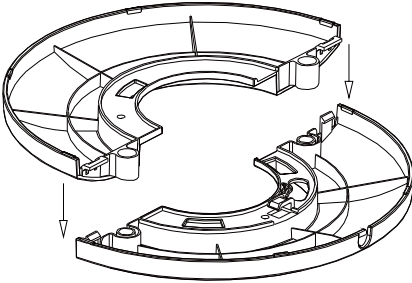

1. Plaats de twee helften van de basis samen. Zie stap 1.

Stap 2

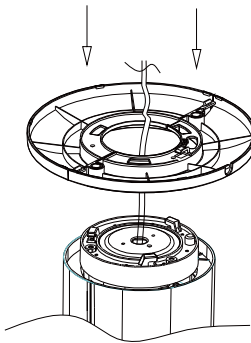

2. Plaats de basis op de onderkant van de ventilator, leid het stroomsnoer langs de basis en zorg dat de sluitingen op de behuizing van de ventilator zijn uitgelijnd met de gaten in de basis. Zie stap 2.

Stap 3

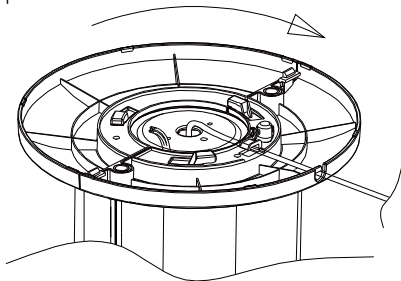

3. Draai de basis naar rechts tot deze op zijn plek vastzit. Leid het stroomsnoer vervolgens door de geleiders in de onderkant van de basis door het snoer voorzichtig in de klemmetjes te duwen. Zie stap 3.

3 Bediening

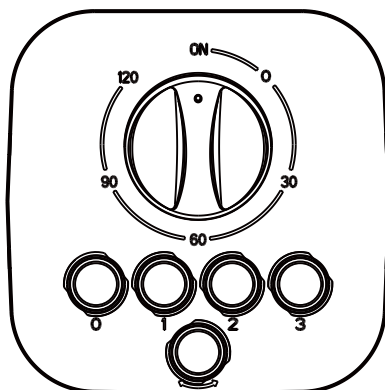

Knoppen: Druk op de selectieknop om een gewenste snelheid te kiezen.

"1" voor laag,

"2" voor medium,

"3" voor hoog,

"0" voor uitschakelen

Oscillatie: Druk op de knop "↔" op de bovenkant van de ventilator om de oscillatie te starten. Druk nogmaals om te stoppen.

Timer: 2 uur timer

Om de timer te gebruiken, draait u de timerbediening naar rechts om de ventilator voor de geselecteerde duur aan te zetten.



Warmte tips

Draai de timer niet naar links naar "ON" (AAN) van "120".

5 Verwijdering



Opmerking: Gooi geen elektrische apparaten weg als gemeentelijk afval, gebruik altijd afzonderlijke verzamelinstituten. Neem contact op met uw lokale gemeente voor informatie met betrekking tot de beschikbare verzamelsystemen. Als het elektrische apparaat op stortplaatsen of vuilnisbelten wordt weggegooid, kunnen er gevaarlijke substanties in het grondwater lekken en in de voedselketen terecht komen, waardoor uw gezondheid kan worden geschaad.



Dit product voldoet aan de EU-richtlijn WEEE (2012/19/EU). Dit product is voorzien van een classificatiesymbool voor afvalsortering van elektrische en elektronische apparatuur (WEEE). Dit symbool geeft aan dat dit product niet met ander huishoudelijk afval mag worden weggegooid aan het einde van zijn levensduur. Het gebruikte apparaat moet worden ingeleverd bij het officiële inzamelingspunt voor recycling van elektrische en elektronische apparaten. Voor de locatie van deze inzamelingspunten neemt u contact op met de plaatselijke gemeente of winkelier waar u het product heeft gekocht. Ieder huishouden heeft een belangrijke rol in de herwinning en recycling van oude apparaten. Correcte verwijdering van gebruikte apparaten helpt potentiële negatieve consequenties voor het milieu en de gezondheid van de mens te voorkomen.

Informatie			
Beschrijving	Symbool	Waarde	Eenheid
Maximaal ventilatordebiet	F	10	m ³ /min
Elektrisch opgenomen vermogen	P	35	W
Servicewaarde	SV	0,29	(m ³ /min)/W
Stroomverbruik in stand-by	P _{SB}	0	W
Geluidsvermogeniveau van de ventilator	L _{WA}	62	dB(A)
Maximale luchtsnelheid	C	5,0	meter/sec
Meetstandaard voor servicewaarde	IEC 60879:1986+ (corr. 1992)		
Contactgegevens voor het verkrijgen van meer informatie	Arcelik: Arcelik AS. Sutluce. Karaagac Cd. 2-6, 34445 Beyoglu Istanbul Turkey		

4 Overige

4.1 Onderhoudsinstructies

De ventilator heeft weinig onderhoud nodig. Probeer hem niet zelf te repareren. Neem indien nodig contact op met gekwalificeerd onderhoudspersoneel.

1. Voor het reinigen en in elkaar zetten moet de ventilator losgekoppeld zijn.
2. Voor voldoende luchtstroom naar de motor, moet de ventilatie aan de achterkant van de motor stofvrij blijven. Haal de ventilator niet uit elkaar om het stof te verwijderen.
3. Veeg de buitenkant schoon met een zachte doek en mild schoonmaakmiddel.
4. Gebruik geen schuurmiddel of oplosmiddel om schade aan het oppervlak te voorkomen. Gebruik geen benzine of verdunner.
5. Laat geen water of andere vloeistoffen in de motorbehuizing of de binnenste onderdelen lopen.

4.2 Reinigen

1. Koppel de ventilator los voor u het apparaat reinigt.
2. Plastic onderdelen moeten worden gereinigd met een vochtige doek en milde zeep. Verwijder de zeeplaag grondig met een droge doek.

4.3 Technische gegevens

Voeding: 220-240 V~, 50 Hz

Technische en ontwerpaanpassingen voorbehouden.

Importer in Poland Importer w Polsce Beko S.A. ul. Puławska 366 02-819 Warszawa www.beko.pl	Importer in Czech Republic Dovožce do České republiky BEKO S.A., organizační složka Bucharova 1423/6, Praha 13 – Nové Butovice, 158 00 www.bekocr.cz	Importer in Slovakia Dovožca na Slovensko BEKO Slovakia s.r.o. Suché myto 1 811 03 Bratislava www.bekosk.sk	Importer in Estonia Importija Eesti Beko S.A. Tänav Puulawska 366 02-819 Varssavi (Poola)	Importer in Norway Karenslyst Allé 2 0278 Oslo
Importer in UK BEKO Plc, Beko House, 1 Greenhill Crescent, Watford, Herts, WD18 8QU	Importer in Germany Beko Grundig Deutschland GmbH Thomas-Edison-Platz 3 63263 Neu-Isenburg	KSA Importer HUSSEIN & ALHASSAN G. SHAKER BROS. FOR MODERN TRADING CO. LTD. Hail Street – Al Bughdadiyah Al Gharbeyah District Shaker Building – 6th floor (+966)126454227	Importer in France BEKO France / Immeuble Stadium, 266, Avenue du Président Wilson 93218 La Plaine Saint-Denis Cedex	
Importer in Spain BEKO ELECTRONICS ESPANA S.L.C/ Provenza, 388. 3a planta, 08025 Barcelona	Importer for Malta ETV LTD 119/120 Archbishop Street VALLETTA MALTA	Importer in Latvia Importētāja Latvijā Beko S.A. Ielas Puļawska 366 02-819 Varšava (Polija)	Importer in Switzerland Secomp AG Grindelstrasse 6 CH-8303 Bassersdorf Switzerland	Importer in Lithuania Importuotojas Lietuvoje Beko S.A. Gatvė Puļawska 366 02-819 Varšuva (Lenkija)
Importer in Austria ELEKTRA BREGENZ AG PFARRGASSE 77 VIENNA post code 1230	Importer in Sweden Grundig Nordic AB Klarabergsviadukten SE-11164 Stockholm	Importer in Hungary Hauser Magyarorszag imited Baross utca 89 PC: 2040 Budaörs / Hungary	Importer in Slovenia BIG BANG, D.O.O. Šmartinska cesta 152 PC: 1000 Ljubljana/Slovenia	Importer in Italy BEKO ITALY SRL Viale Del Ghisallo, 201/20151 Milano (MI)
Importer in Romania ARCTIC S.A. Str. 13 Decembrie, nr.210 Găești, 135200, România www.arctic.ro	Importer in Belgium Asogem NV/SA Schalihenoevedreef 26 2800 Mechelen Belgium	Importer in Greece PAR. SEITANIDIS S.A. Polistilo, P.O. Box:1402 Kavala, 64003	Importer in Bulgaria VIDEOLUX Ltd. 265, Okolovrasten pat Str. Mladost 4, 1766 Sofia, Bulgaria	Importer in Croatia E PLUS doo ZA Unamrju / GOSPODARSKA 16c / 10225 GORNJI STUPNIK / ZAGREP
Importer in Russia Импортёр на территории РФ: ООО «БЕКО», РФ, 601021, Владимирская обл., Киржачский р-н Муниципальное образование сельское поселение Першинское, дер. Федоровское, ул. Сельская, д. 49 Бесплатная линия сервисного обслуживания и информационной поддержки по установке и эксплуатации (только для звонков по России) 8-800-200-23-56 Изготовитель: Arcelik A.Ş. Турция, Karaağaç Caddesi No: 2-6 Istanbul 34445 Sutluce, Istanbul				
Виробник: "Arçelik A.S." Karaağaç Caddesi No: 2-6 Sütlüce, 34445, Turkey/ "Arçelik A.S.", м. Стамбул, Сютлюдже, вул. Караагач № 2-6, 34445, Туреччина, Термін служби 10 років Імпортер на території України: ТОВ «Бекo Україна», адреса: 03150, м. Київ, вул. Антоновича, буд. 72 тел/факс.: 0-800-500-4-3-2				
Manufactured by Arcelik A.S. Karaagac Cd. No:2-6 34445 Sutluce, Beyoglu, Istanbul, Turkey SDA-HVAC-11-20-05				

