



Microwave Oven

User Manual



MOC20100B - MOC20100S

EN



01M-8819353200-2121-01
01M-8819363200-2121-01

CONTENTS

1 Important safety and environmental instructions 4

1.1 Safety warnings	4
1.2 Compliance with the WEEE Directive and Disposing of the Waste Product:	9
1.3 Compliance with RoHS Directive	9
1.4 Package information	9

2 Your microwave oven 10

2.1 Overview	10
2.2 Technical data	10

3 Description of the product 11

3.1 Control panel	11
3.2 Power setting	11
3.3 Accessories	12
3.4 Microwave oven cookware	12

4 Operating your product 13

4.1 Placing the food	13
4.2 Useful suggestions	13
4.3 Operating your oven	14
4.4 Cooking table	15
4.5 Defrosting	17
4.6 Heating	18

5 Cleaning and Care 19

5.1 Outer surfaces	19
5.2 Inner surfaces	19
5.3 Storage	19
5.4 Handling and transportation	19

Please read this manual first!

Dear Customer,

Thank you for selecting a Beko product. We hope that you get the best results from your product which has been manufactured with high quality and state-of-the-art technology. Therefore, please read this entire user manual and all other accompanying documents carefully before using the product and keep it as a reference for future use. If you handover the product to someone else, give the user manual as well. Follow all warnings and information in the user manual.

Meanings of the symbols

Following symbols are used in the various section of this user manual:

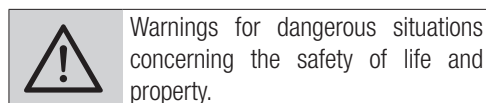
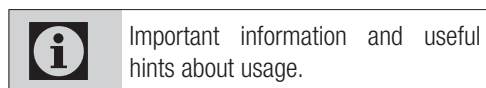

This product has been manufactured in environmentally modern facilities.

1 Important safety and environmental instructions

Important Safety Instructions Read Carefully And Keep For Future Reference

1.1 Safety warnings

This section contains safety instructions that will help protect from risk of fire, electric shock, exposure to leak microwave energy, personal injury or property damage. Failure to follow these instructions shall void any warranty.

- Beko Microwave Ovens comply with the applicable safety standards; therefore, in case of any damage on the appliance or power cable, it should be repaired or replaced by the dealer, service center or a specialist and authorized service alike to avoid any danger. Faulty or unqualified repair work may be dangerous and cause risk to the user.
- This appliance is intended to be used in household and similar applications such as:
 - Staff kitchen areas in shops, offices and other working environments;
 - Farm houses
 - By clients in hotels, and other residential type environments;
 - Bed and Breakfast type environments.
- It is not intended for industrial or laboratory use.
- Do not attempt to start the oven when its door is open; otherwise you may be exposed to harmful microwave energy. Safety locks should not be disabled or tampered with.
- The microwave oven is intended for heating food and beverages. Drying of food or clothing and heating of warming pads, slippers, sponges, damp cloth and similar may lead to risk of injury, ignition or fire.

1 Important safety and environmental instructions

- Do not place any object between the front side and the door of the oven. Do not allow dirt or cleaning agent remnants to build up on the closure surfaces.
- Any service works involving removal of the cover that provides protection against exposure to microwave energy must be performed by authorized persons/service. Any other approach is dangerous.
- Your product is intended for cooking, heating and defrost food at home. It must not be used for commercial purposes.
- Your oven is not designed to dry any living being.
- Do not use your appliance to dry clothes or kitchen towels.
- Do not use this appliance outdoors, bathrooms, humid environments or in places where the it can get wet.
- No responsibility or warranty claim shall be assumed for damages arising from misuse or improper handling of the appliance.
- Never attempt to dismantle the appliance. No warranty claims are accepted for damage caused by improper handling.
- Only use the original parts or parts recommended by the manufacturer.
- Do not leave this appliance unattended while it is in use.
- Always use the appliance on a stable, flat, clean dry, and non-slip surface.
- The appliance should not be operated with an external clock timer or separate remote control system.
- Before using the appliance for the first time, clean all parts. Please see the details given in the “Cleaning and Maintenance” section.
- Operate the appliance for its intended purpose only as described in this manual.
- Appliance becomes very hot while it is in use. Pay attention not to touch the hot parts inside the oven.

1 Important safety and environmental instructions

- Do not operate the oven empty.
- Cooking utensil may get hot due to the heat transferred from the heated food to the utensil. You may need oven gloves to hold the utensil.
- Utensils shall be checked to ensure that they are suitable for use in microwave ovens.
- Do not place the oven on stoves or other heat generating appliances. Otherwise, it may be damaged and the warranty becomes void.
- Steam may come out while opening the covers or the foil after cooking the food.
- The appliance and its accessible surfaces may be very hot when the appliance is in use.
- Door and outer glass may be very hot when the appliance is in use.
- Make sure that your mains power supply complies with the information supplied on the rating plate of the appliance.
- The only way to disconnect the appliance from the power supply is to remove the power plug from the power outlet.
- Use the appliance with a grounded outlet only.
- Never use the appliance if the power cable or the appliance itself is damaged.
- Do not use this appliance with an extension cord.
- Never touch the appliance or its plug with damp or wet hands.
- Place the appliance in a way so that the plug is always accessible.
- Prevent damage to the power cable by not squeezing, bending, or rubbing it on sharp edges. Keep the power cable away from hot surfaces and naked flame.
- Make sure that there is no danger that the power cable could be accidentally pulled or that someone could trip over it when the appliance is in use.

1 Important safety and environmental instructions

- Unplug the appliance before each cleaning and when the appliance is not in use.
- Do not pull the power cable of the appliance to disconnect it from its power supply and never wrap its power cable around the appliance.
- Do not immerse the appliance, power cable, or power plug in water or any other liquids. Do not hold it under running water.
- When heating food in plastic or paper containers, keep an eye on the oven due to the possibility of ignition.
- Remove the wire strings and/or metal handles of paper or plastic bags before placing bags to the oven.
- If smoke is observed, switch off or unplug the appliance if safe to do so and keep the door closed in order to stifle any flames.
- Do not use microwave oven for storage. Do not leave paper items, cooking material or food inside the oven when it is not being used.
- The contents of feeding bottles and baby food jars should be stirred or shaken and the temperature checked before consumption, in order to avoid burns.
- This appliance is a Group 2 Class B ISM equipment. Group 2 contains all ISM (Industrial, Scientific and Medical) equipment in which radio-frequency energy is intentionally generated and/or used in the form of electromagnetic radiation for the treatment of material, and spark erosion equipment.
- Class B equipment is suitable for use in domestic establishments and establishments directly connected to a low voltage power supply network.
- Do not use cooking oil in the oven. Hot oil may damage the components and materials of the oven, and it may even cause skin burns.
- Pierce food with thick crust such as potatoes, courgettes, apples and chestnuts.

1 Important safety and environmental instructions

- Appliance must be placed so that the rear side is facing the wall.
- Before moving the appliance, please secure the turntable to prevent damage.
- Eggs in their shell and whole hard-boiled eggs must not be heated in microwave ovens since they may explode, even after microwave heating has ended.

WARNING: If the door or door seals are damaged, the oven must not be operated until it has been repaired by a competent person.

WARNING: It is hazardous for anyone other than a competent person to carry out any service or repair operation which involves the removal of a cover which gives protection against exposure to microwave energy.

WARNING: Liquids and other foods must not be heated in sealed containers since they are liable to explode.

- The oven should be cleaned regularly and any food deposits removed.
- There should be min 20 cm free space above the top surface of the oven.
- Do not over-cook foods; otherwise, you may cause a fire.
- Do not use chemicals and steam assisted cleaners to clean the appliance.
- Extreme caution is advised when being used near children and persons who are restricted in their physical, sensory or mental abilities.
- This appliance can be used by the children who are at the age of 8 or over and by the people who have limited physical, sensory or mental capacity or who do not have knowledge and experience, as long as they are supervised with regard to safe use of the product or they are instructed accordingly or understand the risks of using the product. Children should not play with the appliance.

1 Important safety and environmental instructions

Cleaning and user maintenance procedures should not be performed by children unless they are controlled by their elders.

- Danger of choking! Keep all the packaging materials away from children.
- Due to excessive heat that arises in grill and combination modes, children should only be allowed to use these modes under supervision of an adult.
- Keep the product and its power cable so that they are inaccessible by children under 8 years old.
- Do not cook food directly on the glass tray. Put the food in / on appropriate kitchen utensils before placing them in the oven.
- Metallic containers for food and beverages are not allowed during microwave cooking. Otherwise, sparking may occur.
- This product is not designed to be built-in. Do not place the product in a cabinet or box while it is in use.

1.2 Compliance with the WEEE Directive and Disposing of the Waste Product:

This product complies with EU WEEE Directive (2012/19/EU). This product bears a classification symbol for waste electrical and electronic equipment (WEEE).

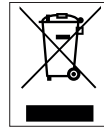

This symbol indicates that this product shall not be disposed with other household wastes at the end of its service life. Used device must be returned to official collection point for recycling of electrical and electronic devices. To find these collection systems please contact to your local authorities or retailer where the product was purchased. Each household performs important role in recovering and recycling of old appliance. Appropriate disposal of used appliance helps prevent potential negative consequences for the environment and human health.

1.3 Compliance with RoHS Directive

The product you have purchased complies with EU RoHS Directive (2011/65/EU). It does not contain harmful and prohibited materials specified in the Directive.

1.4 Package information



Packaging materials of the product are manufactured from recyclable materials in accordance with our National Environment Regulations. Do not dispose of the packaging materials together with the domestic or other wastes. Take them to the packaging material collection points designated by the local authorities.

2 Your microwave oven

2.1 Overview

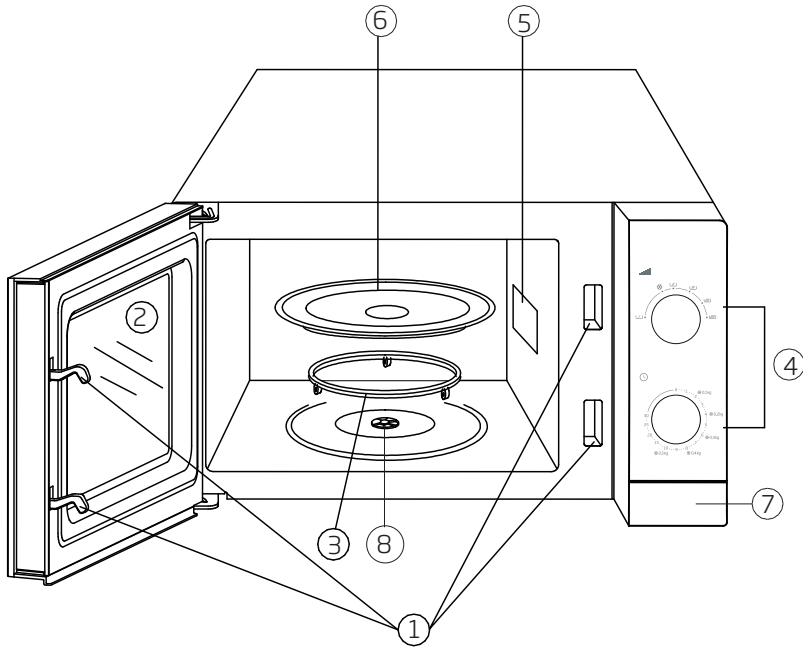

1. Door lock system
2. Front door glass
3. Rotating base support
4. Control panel
5. Microwave guide
6. Glass plate
7. Door open key
8. Shaft

2.2 Technical data

Supply Voltage	230V~ 60Hz
Output Power	700 W
Total Power	1200 W
Time	0-30 minutes
Dimension	455(W) x 350(D) x 260(H) mm
Oven Volume	20 L
Net Weight	10.6 kg
Colour	Silver / Black

Technical and design modification rights are reserved.

Markings on the appliance or the values stated in other documents supplied with the product are values obtained under laboratory conditions as per relevant standards. These values may vary according to the usage of the appliance and ambient conditions.

3 Description of the product

3.1 Control panel

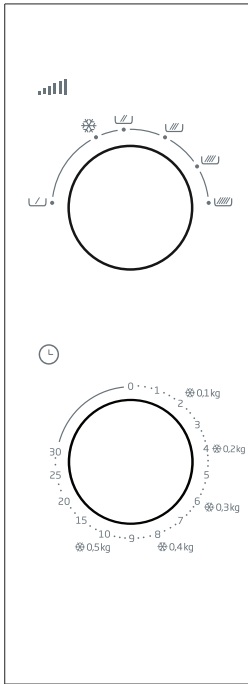

Power setting button







Time setting button

3.2 Power setting

The setting button at the upper section of the control panel will allow you to use any of the

6 different power levels.

The following table contains some sample meals and corresponding power levels to cook them in the microwave oven.

Power Level	Usage
High 700 W 	<ul style="list-style-type: none">- Boiling water- Minced meat- Cooking chicken/turkey, fish and vegetables- Cooking thin sliced meat
Medium-High 600 W 	<ul style="list-style-type: none">- Reheating all sorts of food- Cooking meat and poultry- Cooking mushroom- Cooking foods that contain cheese or egg
Medium 460 W 	<ul style="list-style-type: none">- Cooking cakes and pastries- Cooking eggs (not in the shell)- Cooking soup or rice
Medium-Low 350 W 	<ul style="list-style-type: none">- Melting butter and chocolate
Defrosting 	<ul style="list-style-type: none">- Thawing frozen food
Low 120 W 	<ul style="list-style-type: none">- Softening butter and cheese- Softening the ice cream- Raising the yeast dough

3 Description of the product

3.3 Accessories

Glass plate

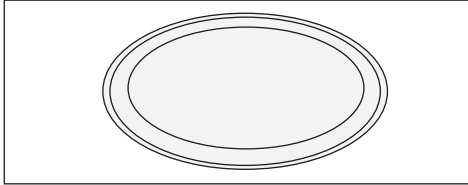

Use the glass plate during cooking, as this will serve to collect cooking juices and food remnants and prevent these from dirtying the base of the microwave oven.

- The glass plate can be washed in a dishwasher.
- Place the glass plate onto the rotating base.

Rotating base

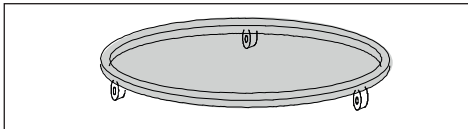

The rotating base must be placed below the glass plate. Do not place any other plate apart from the supplied glass plate onto the rotating base. Wash the rotating base with warm and soapy water at least once a week.

The rotating base must be fit securely into its seating.

3.4 Microwave oven cookware

- Use round cookware for cooking instead of elliptic or rectangular cookware. Otherwise, the food that remains on the edges will be effected more by the microwave and edges will get overcooked.
- Microwave can pass through substances such as paper, plastic, glass and ceramic without producing any heat. Cookware made of such materials can be suitable for use in cooking in some cases.

- You can employ the following method to check whether the cookware you will put your food is suitable for microwave cooking.
- Place the empty cookware with a glass full of water on it onto the glass plate in microwave oven and select and run Max power level for 60 seconds. Cookware that overheat after this process should not be used.

Metal cookware - foils

Metal cookware reflects the microwaves away from the food. Therefore, do not use them. Aluminum foil in small pieces or stripes can be used to cover wings or legs, or the parts that remain on the edge such as thin tips of the joints of poultry. Flat cooking trays with a depth less than 1.5 cm on the edges can also be used; however, in such grease proof paper and cling film should be used instead of foil.

Glass cookware

Very thin glass cookware and crystal with lead content should not be used.

Plastic cookware - bags

Melamine cookware and lids as well as the bags used for freezing or preservation should not be used.

Paper

Do not use any type of paper during cooking in the microwave oven.

Wooden or wicker cookware

Large wooden cookware should not be used as the microwave energy causes the wood get dry and crispy.

4 Operating your product

4.1 Placing the food

- You will get the best results if you scatter the food into the plate. This may be achieved in various ways to get better results.
- If you will cook too many pieces of the same type (such as potatoes with skin) place them in a circular form.
- When cooking food with different shapes and thicknesses, place the smallest and thinnest part into the middle of your cookware. Thus, you can have that piece cooked last.
- Place food with irregular shape such as fish in a way that their tails will be in the middle of the cookware.
- When storing a meal in the refrigerator or heating it, place the thick and dense ones to out and thin and less dense ones in.
- Place thin sliced meat pieces on top of each other.
- Thicker pieces such as sausage and chopped meat should not be placed close to each other.
- Heat broth and sauces in separate cookware. Prefer narrow and long cookware to wide and long ones. Do not fill more than 2/3 of the cookware when heating broth, sauce or soup.
- If you will cook whole fish, make some cuts on it; thus you will prevent skin from bursting.
- Cover the head and tail parts of the fish with aluminum foil to protect them against overcooking.
- If you are using cling film, a cooking bag or grease proof paper, make a hole or leave a small opening in order to allow steam get out.
- Food with small pieces will get cooked sooner than the ones with large pieces and the ones with regular shapes will get cooked sooner than the ones with irregular shapes. Cut the food in even sizes and regularly to cook them in the best way possible.

4.2 Useful suggestions

To defrost

- Shape of the package may change the defrost time. Shallow rectangular packages will defrost quicker than the deep cookware.
- Separate the pieces from each other as they get defrosted. Thus other pieces will defrost easier.
- Cover the parts of the food that start heating with small pieces of foil. Wood toothpicks will help keeping the foil in place.

Amount of food

The more food you cook the more time it will take. Double amount of food mean double amount of time.

Moisture content

Cooking time will change depending of the amount of juice as microwave is sensitive to moisture. Food with natural juice (vegetables, fish and poultry) will get cooked quickly and easily. Adding water is suggested when cooking dry food such as rice and beans in microwave.

Condensation

Moisture in food items may sometimes cause condensation inside the oven during cooking. This is normal. Generally, foods that are covered will cause less condensation.

Sugar

Follow the suggestions in microwave cooking books when cooking food items such as pudding or tart which contain too much sugar or butter. If you exceed the suggested time, you may cause the food item get burned or the oven get damaged.

4 Operating your product

Reducing the pressure in foods

Many food items are covered with skin or shell. They may crack due to the pressure that builds up during cooking. To avoid this, the skin or shell must be punctured with a fork or knife. This process must be applied to potato, chicken liver, egg yolk, sausage and some fruits.

Mixing and turning the food during cooking

Mixing and turning the food is important in terms of cooking all parts evenly.

Different cooking times

Always start by trying the minimum cooking time and check whether the food is cooked or not. Cooking times in this user manual are approximate values. Cooking times may vary depending on the sizes and shapes of the foods and cookware.

Resting time

Always keep the food resting for some time after taking it from the microwave oven. Resting food for some time after defrosting, cooking and reheating will always give better results. Because the heat of the food will dissipate well. In microwave ovens, foods continue to cook for some more time even after the microwave oven is switched off. Cooking continues not because of the microwave oven but the energy inside the food. The resting time may change depending on the meal. In some cases, this duration is as short as it takes you to take the meal from the microwave oven and transfer it to the service plate. This time may take up to 10 minutes and depends on the type and size of the food.

















4.3 Operating your oven

1. Always plug your oven into grounded sockets.
2. Open the front door.
3. Place the meal or meal tray on the rotary tray in the oven.
4. Turn the time setting button in clockwise to set the desired time. First pass the desired time a little bit to make the time setting correctly. Then go back to the desired time.
5. Close the front door securely. Your oven's light will turn on and it will start. Oven will not start if the door is not closed securely.
6. Open the door from time to time to mix or check the meal (this may disturb the cooking process). Cooking process and time setting will stop when you open the front door and will resume when the front door is closed again.
7. You can stop the oven by opening the front door during cooking. Do not forget to set the time to (0) position if you do not want to continue cooking.
8. Buzzer will be activated at the end of the set cooking time. Oven light turns off and cooking ends automatically.

4 Operating your product

4.4 Cooking table





















Because of microwave cooking feature keep food waiting for some time after cooking is over. This duration is 5-10 minutes for food meats and 2-3 minutes for vegetables.

Food	Power Level	Cooking Time
Meats		
Minced beef	()	3-5 minutes for ~ 500 g
Meatball	()	9-12 minutes for ~ 500 g
Hamburger	()	4-5 minutes for ~ 500 g
Steaks (3 pieces of 0.5 cm thick)	()	1.5-2.5 minutes
Lamb roast, shank or shoulder	() - ()	8-10 minutes for ~ 500 g
Veal, roasted arm	() - ()	9-10 minutes for ~ 500 g
Lamb/veal cubes (3-4 pieces)	()	~ 6-8 minutes
Poultry		
Chicken pieces (1 breast)	()	2-3.5 minutes
Chicken pieces (1 drumstick)	()	1.5-2.5 minutes
Whole chicken	()	9-10 minutes for ~ 500 g
Casserole (for 1 person)	()	1.5-3.5 minutes
Turkey breast	()	8-9 minutes for ~ 500 g
Fish and seafood		
Fillet / sliced (170-230 g)	()	1.5-2.5 minutes
Whole fish	()	7-9 minutes for ~ 500 g

- Cooking times in table are provided for information purposes only. You can increase or decrease the cooking time according to your palate.
- The values stated have been obtained in laboratory testing. For personal preferences the cooking time can be changed.

4 Operating your product

Cooking table

Food	Power Level	Cooking Time
Egg and cheese		
Fried egg	()	1-2 minutes per egg
Scrambled eggs	()	45/-90 sec. to melt the butter and then 1-2 minutes per egg
Dessert with egg (caramel custard) 20 x 20 cm	()	15-19 minutes
Vegetables		
Vegetables (1 person)	()	1.5-3 minutes
Green beans	()	~ 500 g 8-12 minutes
Cabbage (freshly chopped)	()	6-8 minutes for ~ 500 g
Carrot (freshly chopped)	()	3-6 minutes for ~ 200 g
Corn (fresh 2 pieces)	()	5-9 minutes
Mushroom (freshly chopped)	()	2-3 minutes for ~ 230 g
Potatoes (4 pieces, 170-230 g each)	()	10-15 minutes
Spinach (fresh, leaves)	()	5-8 minutes for ~ 500 g
Grains		
1/2 fast cooking oatmeal (water: 1 cup)	()	1-2 minute(s)
1/2 long cooking oatmeal (water: 1 cup)	()	2-4 minutes
1/2 corn puree (water: 2 cups)	()	2-3 minutes
Cakes		
Carrot cake	()	9-12 minutes
Plain or chocolate cake (in round vessel)	()	5-6 minutes
Round cake	()	5-5.5 minutes
Small cake in mould	()	2-2.5 minutes
Cookies (foursquare vessel)	()	3-6 minutes
Soup/beverage		
for 1 person	()	2-3 minutes

4 Operating your product

4.5 Defrosting

Defrosting food in a short time is one of the biggest advantages of the microwave oven. First remove the metal fastening wires of the frozen food bags and replace them with thread or rubber. Open the packaging made of materials such as cardboard before placing them into the oven. Cut or pierce the plastic bags or packages. If the food is in foil packaging, remove the foil and place the food in a suitable vessel. (If the frozen food has skin, remove the skin.) Flex the plastic bag on the food to provide even defrosting.

(While defrosting large pieces of meat, do not forget to cover the thin parts of the poultry in order to slow down heating. Otherwise, outer parts will dry out or even start being cooked.)

Always keep the defrost time short. If inside of the defrosted food is still frozen, place it back to the microwave oven to defrost it some more.

Duration of the defrosting time depends on food's level of freezing. If possible, turn or take apart the frozen food during defrosting.

Defrosting table contains approximate values to help you.

Defrosting table

Please read information about defrosting.

Food	Recommended time	Kg
Sausage	5-6 minutes	500 g
Minced meat	8-10 minutes	500 g
Kidney	8-12 minutes	1 kg
Liver	6-7 minutes	500 g
Lamb chops rib	15-20 minutes	1.5-2 kg
Top round	20-25 minutes	1.5-2 kg
Meat cubes	7-8 minutes	500 g
Fillet of beef	10-12 minutes	1 kg
Veal cutlet	9-10 minutes	500 g
Minced meat (veal)	4-5 minutes	500 g
Veal steak	6-8 minutes	500 g
Lamb roast leg or shoulder	28-30 minutes	2-2.3 kg
Whole chicken	26-30 minutes	1.2-1.5 kg
Chicken pieces	14-17 minutes	1.2-1.5 kg
Chicken breast (with bones)	10-14 minutes	1-1.5 kg
Chicken pieces (drumstick)	9-10 minutes	500 g
Chicken pieces (wing)	8-12 minutes	700 g
Turkey pieces	14-16 minutes	1-1.5 kg
Turkey breast (with bones)	18-22 minutes	2-2.5 kg

4 Operating your product













4.6 Heating

You can reheat the remaining or cooked food quickly and effectively without losing their freshness and taste.

During heating, cover the food with a lid or cling film suitable for microwave cooking in order to allow the food to remain moist. Covering the food will protect the heat and speed up the heating process. It will also avoid splashes. Wrap the sandwiches and cookies in paper towels in order to allow moisture absorption and prevent them from getting doughy.

Generally spread the food into a shallow vessel. It may be necessary to mix and turn the food from time to time to heat it.

Heating table

	Food	Power Level	Cooking Time
1 portion	1 plate	()	2-3 minutes
1-2 portion(s)	Main course with sauce	()	7-9 minutes
2-4 portions	Thick meat slices such as hamburger, rolled meatball slices	()	3-5 minutes
2-3 portions	Thin meat slices such as steak fillet	()	2-3 minutes
2-3	Chicken pieces	()	3-4 minutes
2 portions	Casserole	()	9-12 minutes
2 portions	Vegetables	()	3-4 minutes
1-2	Corn	()	3-4 minutes
2-3	Cookies	()	45-60 seconds
1	Whole pie	()	3-7 minutes
1-2 slices	Pie	()	1-2 minute(s)
3-4	Sausage	()	1-2 minute(s)
4	Hot dog	()	1-2 minute(s)

5 Cleaning and Care



WARNING: Never use gasoline, solvent, abrasive cleaning agents, metal objects or hard brushes to clean the appliance.



WARNING: Never immerse the appliance or its power cable in water or in any other liquid.

Unplug your oven before cleaning.

5.1 Outer surfaces

- To clean the outer surfaces of the oven, first wipe them with a soft cloth soaked in warm soapy water. Then wipe them dry again with a soft cloth.
- Do not allow water ingress into the ventilation openings in order to avoid damage to the live parts inside the oven. Clean the control panel of your microwave oven only with a damp and soft cloth.
- Do not use cleaning sprays or more soap and water. They may cause problems in control mechanism.
- Failure to maintain the oven in a clean condition could lead to deterioration of the surface that could adversely affect the life of the appliance and possibly result in a hazardous situation.
- Cleaning the door seals and adjacent parts: Use hot soapy water. Clean with a dish cloth, do not scour. Do not use a metal or glass scraper for cleaning.

5.2 Inner surfaces

To clean the inner surfaces of the oven:

- To soften the dried stains, place a glass of water inside the microwave oven and heat for 2-3 minutes. The steam created will soften dried stains making cleaning easier.
- Clean the inner surfaces and ceiling with a soft and soapy cloth. And dry again with a soft cloth.

- To remove the odours inside the oven, boil a mixture of water and a few table spoons of lemon juice for a couple of minutes inside the oven.
- To clean the inner base of the oven, remove the roller glass tray and roller support. Wash the roller glass tray and roller support in soapy water. Then, rinse and dry them.
- Before starting the oven, install the roller support and glass tray securely.
- When cleaning the inner surfaces of the oven door, use a non-abrasive soft sponge or cloth.

5.3 Storage

- If you do not intend to use the appliance for a long time, please store it carefully.
- Please make sure that the appliance is unplugged, cooled down and totally dry.
- Store the appliance in a cool and dry place.
- Keep the appliance out of the reach of children.

5.4 Handling and transportation

- During handling and transportation, carry the appliance in its original packaging. The packaging of the appliance protects it against physical damages.
- Do not place heavy loads on the appliance or the packaging. The appliance may be damaged.
- Dropping the appliance will render it non-operational or cause permanent damage.

Beko Pilipinas Corporation
Taguig City

www.beko.com