



Steam Iron

User Manual



SIM 3122 T - SIM 3124 D

EN







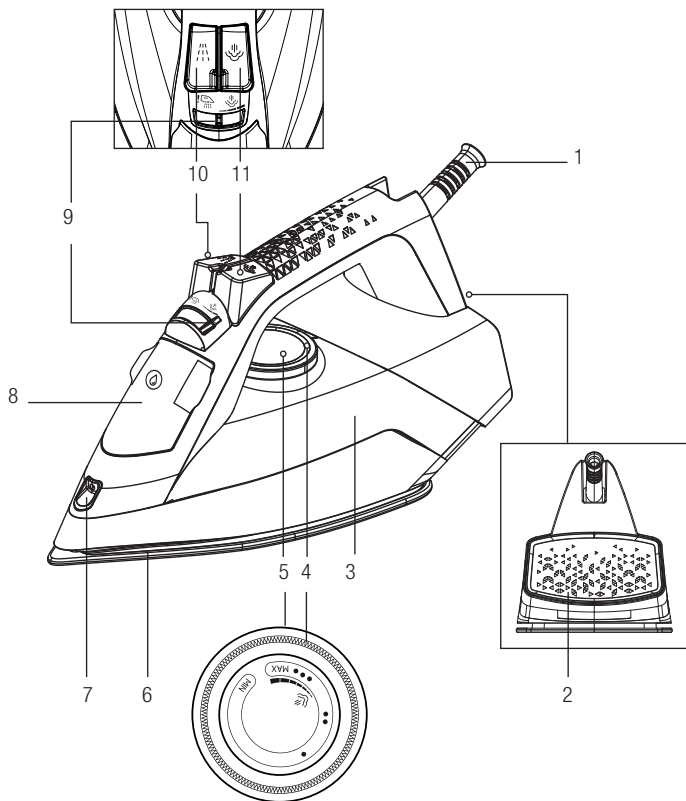

01M-8819313200-4621-02
01M-8819323200-4621-02

CONTENTS

ENGLISH

7-17



			
EN	OPERATION	SHOCK STEAM	AUTOMATIC SHUTDOWN
			
EN	CLEANING AND CARE	SELF-CLEAN	

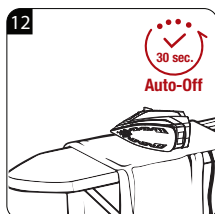
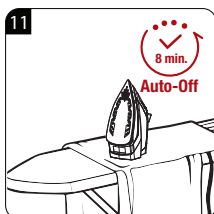
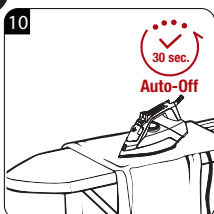
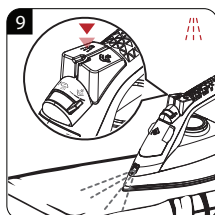
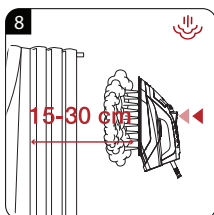
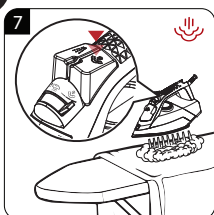
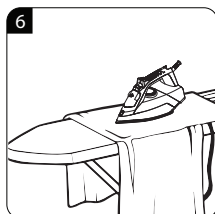
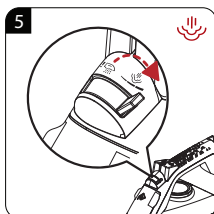
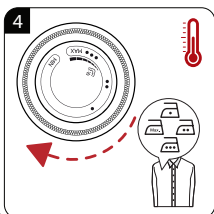
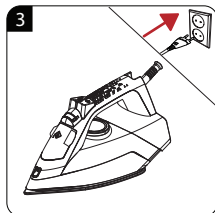
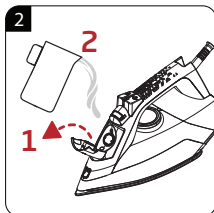
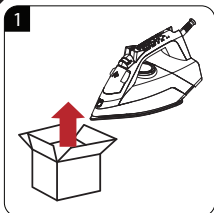

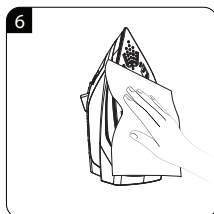
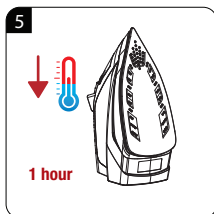
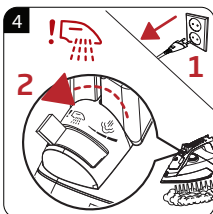
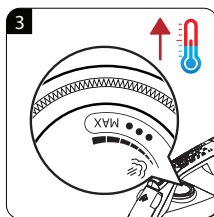
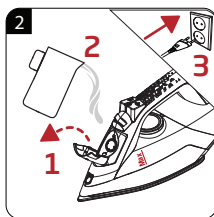
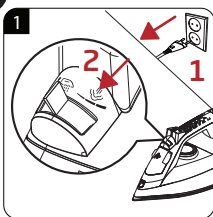
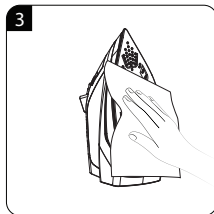
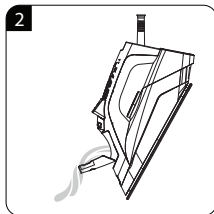
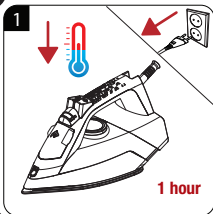
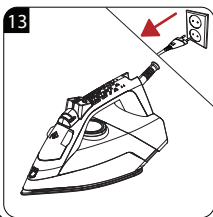

Please read this user manual first!

Dear Customers,

Thank you for selecting a Beko product. We hope that you get the best results from your product which has been manufactured with high quality and state-of-the-art technology. Therefore, please read this entire user manual and all other accompanying documents carefully before using the product and keep it as a reference for future use. If you handover the product to someone else, give the user manual as well. Follow all warnings and information in the user manual.

Meanings of the symbols

Following symbols are used in the various section of this manual:



Important information and useful hints about usage.



WARNING: Warnings for dangerous situations concerning the safety of life and property.



WARNING: Warning for hot surfaces.



WARNING: Risk of burning and scalding due to steam.



This product has been produced in environmentally-friendly, state-of-the-art facilities.

Conforms to the WEEE Directive.

It does not contain PCB.

1. Power cable
2. Iron base plate
3. Water tank
4. Thermostat indicator and Auto-Off light
5. Temperature adjustment knob
6. Soleplate
7. Water spray nozzle
8. Water refill lid
9. Steam adjustment / Self- Clean button
10. Water spraying button
11. Shock steam button

Technical data

	SIM 3122 T	SIM 3124 D
Voltage	220 - 240 V~ 50 - 60 Hz	
Power consumption	2200 W	2400 W
Shock steam amount	up to 140 g/min	up to 145 g/min
Continuous amount of steam	up to 25 g/min	up to 30 g/min
Insulation class	I	

Technical and design modification rights are reserved.

The values which are declared in the markings affixed on your appliance or the other printed documents supplied with it represent the values which were obtained in the laboratories pursuant to the pertinent standards. These values may vary according to the usage of the appliance and ambient conditions.

1 Important safety and environmental instructions

This section contains safety instructions that will help protect from risk of personal injury or property damage.

Failure to follow these instructions invalidates the granted warranty.

1.1 General safety

- This appliance complies with the international safety standards.
- This appliance is not intended for use by persons (including children) with reduced physical, sensory or mental capabilities, or lack of experience and knowledge, unless they have been given supervision or instruction concerning use of the appliance by a person responsible for their safety. Children should be supervised to ensure that they do not play with the appliance. Cleaning and user maintenance shall not be made by children unless they are older than 8 and supervised. Always keep the appliance and its cord out of reach of children aged less than 8 years.

1 Important safety and environmental instructions

- Do not leave the product unattended while it is plugged in.
- Unplug the product before filling the water reservoir with water.
- Operate and store the appliance on a stable surface.
- When the appliance is placed on its base plate, ensure that the surface beneath the plate is level.
- Do not use the appliance if the power cable or the appliance itself is damaged. Contact an authorised service.
- If the appliance is dropped or leaks water or has other failures, contact the authorised service. Do not use the appliance until it is repaired.
- When the appliance is not in use or left to cool down keep the appliance and power cable out of reach of children under 8 years old.
- The appliance is not suitable for using outdoors.

1 Important safety and environmental instructions

- Only use the original parts or parts recommended by the manufacturer.
- Do not attempt to dismantle the appliance.
- Your mains power supply should comply with the information supplied on the rating plate of the appliance.
- The mains supply of the appliance must be secured with a minimum 16 A fuse.
- Use the appliance with a grounded outlet only.
- Do not use the appliance with an extension cord.
- Do not pull the power cable when unplugging the appliance.
- Unplug the appliance before cleaning it.
- Do not wrap the cable around the appliance.
- Do not touch the appliance or its plug with wet or damp hands when the appliance is plugged in.
- The soleplate and its surrounding area can be extremely hot. Contacting hot surfaces may cause burns.

1 Important safety and environmental instructions

Therefore while or just after using the appliance, pay attention not to touch the hot surfaces.

- Never use the appliance in or near to combustible or inflammable places and materials.
- If you keep the packaging materials, store them out of the reach of children.

1.2 Compliance with WEEE Directive and Disposing of the Waste Product

This product complies with EU WEEE Directive (2012/19/EU). This product bears a classification symbol for waste electrical and electronic equipment (WEEE).



This symbol indicates that this product shall not be disposed with other household wastes at the end of its service life. Used device must be returned to official collection point for recycling of electrical and electronic devices. To find these collection systems please contact to your local authorities or retailer where the product was purchased. Each household performs important role in recovering and recycling of old appliance. Appropriate disposal of used appliance helps prevent potential negative consequences for the environment and human health.

1.3 Compliance with RoHS Directive

The product you have purchased complies with EU RoHS Directive (2011/65/EU). It does not contain harmful and prohibited materials specified in the Directive.

1.4 Package Information



Packaging materials of the product are manufactured from recyclable materials in accordance with our National Environment Regulations. Do not dispose of the packaging materials together with the domestic or other wastes. Take them to the packaging material collection points designated by the local authorities.

2 Operation

2.1 Intended use

This appliance is intended only for household use and ironing; it is not suitable for professional use.

2.2 Initial use

Prior to initial use, fill twice and vaporize to remove the manufacturing residues. Meanwhile, use shock steam button (11) frequently.



You can smell a mild odour or see white sediments coming out of the sole-plate holes. After performing vaporizing process twice, such odours and sediments will disappear. Also water droplets may form within the water reservoir; this is normal.

2.3 Refilling the water reservoir



Your appliance is designed for use with tap water. If your tap water is excessively hard, we recommend you to use a mixture of tap water with potable water.

2.4 Setting the temperature



- After the appliance is plugged in, set the temperature according to the type of your fabric by turning the temperature adjustment knob (5) in clockwise direction (see. 2.5).
 - Thermostat indicator light (4) will light up.
- When the appliance reaches the set temperature, thermostat indicator light (4) will turn off and the appliance is ready to use.

2.5 Temperature and steam settings table

When setting the temperature of the appliance, consider the following table.

Fabric Type	Temperature control	Temperature requirement
Silk	•	Low temperature
Wool	••	Medium temperature
Cotton, linen	•••	High temperature
Linen - Jean	Max	High temperature

2 Operation



- If you don't know the fabric of your garment, first iron an invisible part of your garment and determine a correct ironing temperature for it.
- In order to prevent the bright stains that may form on the synthetic fabrics such as silk, iron on the reverse side of the fabric. Do not use the water spraying feature in order to prevent the stain formation.



WARNING: Before ironing first check the label of the garment.

2.6 Steam ironing



WARNING:

- For ironing with steam, temperature adjustment knob should be between “☺” and “max” position.
- Turn the steam adjustment button(9) to desired steam level.

2.7 Shock steam



WARNING:

- Wait for a few seconds before pressing the shock steam button (11) again. Pressing the button repeatedly may cause water come through the soleplate (6) together with steam.
- At the start of ironing, the first few presses may not produce shock steam. To produce shock steam, temperature knob should be at “☺” or higher position.
- In order to use the shock steam feature the thermostat indicator light (4) should be turned off.

2.8 Vertical steam



WARNING:

- Hold the appliance 15-30 cm away from the garment and curtains.
- During the ironing if the thermostat indicator light (4) turns on, before proceeding with the shock steam process wait for the light to turn off.
- Never direct this steam to people or pets.

2 Operation

2.9 Spraying water



You can easily remove creases using the water spraying feature.

2.10 Dry ironing

In order to make dry ironing, set the steam setting button (9) to the “☺” position.



Having water in the appliance would be advantageous; you may use the water spraying button (10) when necessary.

2.11 Anti-dripping system

This iron is equipped with drip stop function: the iron automatically stops steaming when the temperature is too low to prevent water from dripping out of the soleplate.

With the anti-dripping system, you can perfectly iron even the most delicate fabrics.

2.12 Automatic Shutdown (Auto-Off)



- In case of automatic turn off the auto-off light (4) flashes.
- If the appliance is moved in horizontal position it will be turned on.
- It may take 60 seconds for the soleplate (6) to reach the previously set temperature.

3 Cleaning and maintenance

3.1 Cleaning



WARNING:

- When you are finished with ironing, unplug the appliance. You can drain the water in the reservoir by opening the refill lid (8) and tilting the iron to the front.
- Do not use gasoline, solvent and abrasive cleaning agents or hard brush to clean the appliance.

3.2 Anti-Calc system

A special filter inside the water tank softens the water and prevents scale build-up in the soleplate. The filter is permanent and does not need replacing.

3.3 Self clean



The self-cleaning feature cleans inside the soleplate, removing impurities. We recommend using it every 10-15 days.

3.4 Storage

If you do not intend to use the appliance for a long time, store it carefully.

- Before lifting the appliance unplug it and then let it cool completely.
- Empty the water reservoir.
- Keep the appliance and its accessories in their original packages.
- Store it in a cool, dry place.
- Always keep the appliance out of the reach of children.

3.5 Handling and transportation

- During handling and transportation, carry the appliance in its original packaging. The packaging of the appliance protects it against physical damages.
- Do not place heavy loads on the appliance or the packaging. The appliance may be damaged.
- Dropping the appliance will render it non-operational or cause permanent damage.



For commissioning, general use and cleaning, please observe the instructions on pages 5-6 of this operating manual.

4 Troubleshooting

Problem	Possible Reason	Solution
Although the appliance is plugged in, soleplate (6) does not heat up.	The appliance may be connected improperly	Check the plug and power cable (1) of the appliance.
	Temperature adjustment knob (5) may be at the Min. position.	Turn the temperature adjustment knob in the clockwise direction up to the steam sign.
The appliance does not generate steam.	The water reservoir may not have enough water.	Fill the water reservoir with water up to Max level.
	Steam setting button (9) may be at without-steam position.	Switch the steam setting button to the steam position.
Shock Steam – Vertical Steam does not function.	These functions may have been used too frequently in a very short period of time.	Keep ironing at a horizontal position and wait for a while before using the shock steam function again.
	Soleplate (6) may not be hot enough.	Turn the Temperature adjustment knob (5) in the clockwise direction up to the steam sign. Seat the appliance in a vertical position and wait for the soleplate to heat up.
Water drops fall down onto the fabric during ironing.	You may not have securely closed the water refill lid (8).	Close the water refill lid securely.
	You may be using the shock steam at temperature level • or ••.	Increase the temperature level.
During ironing, sediments and residues fall from the soleplate (6).	If the water you use for your appliance is too hard, such sediments may form.	Use the self-clean function for once or a few times. For the subsequent ironings fill the water reservoir of the appliance with a mixture of tap water and potable water.
The appliance drops water after it cools down or stored.	You may have left the appliance on a horizontal position while there is water in its reservoir.	Empty the water reservoir.
Stains at the soleplate (6).	Wet garments might have been ironed and the soleplate (6) has had lime stains.	After the appliance cools enough, wipe the soleplate with a microfiber knitted or cotton cloth soaked in vinegar.

