

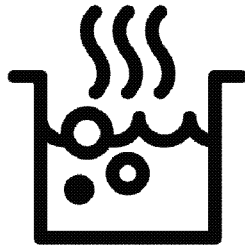

Built-in Hob
User Manual



HII64205F2MT

EN

185.2621.12/R.AA/25.05.2022

7757189244



RECYCLED &
RECYCLABLE PAPER

Dear Customer,

Please read this manual before using the product.

Beko thank you for choosing the product. We want your product, manufactured with high quality and technology, to offer you the best efficiency. To do this, carefully read this manual and any other documentation provided before using the product and keep it as a reference. If you give the product to someone else, give the manual with it.

Follow the instructions, taking into account all the information and warnings stated in the user manual.

Heed all information and warnings in the user manual. This way, you will protect yourself and your product against the dangers that may occur.

Keep the user manual. If you give the product to someone else, give the manual with it.

The user manual contains the following symbols:



Hazard that may result in death or injury.

NOTICE Hazard that may result in material damage to the product or its environment.



Hazard that may result in burns due to contact with hot surfaces.



Important information or useful usage tips.



Read the user manual.



Arçelik A.Ş.
Karaağaç caddesi No:2-6
34445 Söğütözü/İstanbul/TURKEY
Made in TURKEY

This product was manufactured using the latest technology in environmentally friendly conditions.

TABLE OF CONTENTS

1 Safety instructions 4

Purpose of usage	4
Child, vulnerable person and pet safety	4
Electrical safety	5
Transportation safety	6
Installation safety	7
Safety of use	7
Temperature warnings	7
Accessory use	8
Cooking safety	8
Induction	8
Maintenance and cleaning safety	9

2 Environmental Instructions 10

Waste regulation	10
Compliance with the WEEE Directive and Disposing of the Waste Product	10
Package information	10
Recommendations for energy saving	10

3 Your product 11

Product introduction	11
Product control panel introduction and usage	11

Hob control	11
General information on hob	12
Technical specifications	13

4 First use 14

First cleaning	14
----------------------	----

5 How to use the hob 15

General information on hob usage	15
Control panel	18

6 General information about cooking 27







General warnings about cooking with hob	27
---	----

7 Maintenance and care 28

General cleaning information	28
Cleaning the hob	29
Cleaning the control panel	29

8 Troubleshooting 30

1 Safety instructions

- This section contains safety instructions that will help prevent any risks of personal injuries or material damage.
 - If the product is transferred to another person or used second hand, the operating manual, product labels, other relevant documents and accessories should be delivered with the product.
 - Our company shall not be held responsible for any damage that may occur as a result of failure to comply with these instructions.
 - Failure to comply with these instructions shall render any warranty void.
 -  Always have the installation and repair work performed by the manufacturer, the authorized service or a person specified by the importer.
 -  Use genuine spare parts and accessories only.
 -  Do not attempt to repair or replace any part of the product unless it is clearly specified in the operating manual.
 -  Do not perform technical modifications on the product.
-  **Purpose of usage**
- This product is designed for home use. It is not suitable for commercial use.
 - Do not use the product in gardens, balconies or other outdoor environments. The appliance is intended to be used in household and staff kitchen areas in shops, offices and other working environments.
 - **WARNING:** This product should be used for cooking purposes only. It should not be used for different purposes, such as heating the room.
-  **Child, vulnerable person and pet safety**
- This product can be used by children 8 years of age and older, and people who are underdeveloped in physical, sensory or mental skills, or lack of experience and knowledge, as long as they are supervised or trained about the safe use and hazards of the product.

- Children should not play with the product. Cleaning and user maintenance should not be performed by children unless there is someone overseeing them.
- This product should not be used by people with limited physical, sensory or mental capacity (including children), unless they are kept under supervision or receive the necessary instructions.
- Children should be supervised to ensure that they do not play with the product.
- Electrical products are dangerous for children and pets. Children and pets must not play with, climb on, or enter the product.
- Do not put objects that children may reach on the product.
- Turn the handle of the pots and pans to the side of the workbench so that children can not grab and burn.
- **WARNING:** During use, the accessible surfaces of the product are hot. Keep children away from the product.
- Keep the packaging materials out of the reach of children. There is a hazard of injury and suffocation.
- **(Not all products are supplied with a plug, so if your product DOES have a plug)** For the safety of children, disconnect the power plug and make the product inoperable before disposing of the product.



Electrical safety

- Connect the product into a grounded outlet protected by a fuse that matches the current ratings indicated on the type label. Have the grounding installation made by a qualified electrician. Do not use the product without grounding in accordance with local / national regulations.
- The plug or the electrical connection of the product should be in an easily accessible place (where it will not be affected by the flame of the stove). If this is not possible, there should be a mechanism (fuse, switch, switch, etc.) on the electrical installation to which the product is connected, in

compliance with the electrical regulations and separating all poles from the network.

- The product must not be connected into the outlet during installation, repair, and transportation.
- Connect the product into an outlet that meets the voltage and frequency values specified on the type label.
- **(Not all products are supplied with a supply cord, so if your product DOES NOT have a supply cord)**
Use only the connecting cable specified in the "Technical specifications" section.
- Do not jam the power cord under and behind the product. Do not put a heavy object on the power cord. The power cord should not be bent, crushed, and come into contact with any heat source.
- Use original cable only. Do not use cut or damaged cables or extension leads.
- If the power cord is damaged, it must be replaced by a manufacturer, an authorized service or a person to be specified by the importer

company in order to prevent possible dangers.

(Not all products are supplied with a plug, so if your product DOES have a plug)

- Do not plug the product into an outlet that is loose, has come out of its socket, is broken, dirty, oily, with risk of water contact (for example, water that may leak from the counter).
- Never touch the plug with wet hands! To unplug, do not hold the cord, always hold the plug.
- Make sure that the product plug is securely plugged into the outlet to avoid arcing.



Transportation safety

- Disconnect the product from the mains before transporting the product.
- When you need to transport the product, wrap it with bubble wrap packaging material or thick cardboard and tape it tightly. Secure the product tightly with tape to prevent the removable or moving parts of the product and the product from damage.

- Check the overall appearance of the product for any damage that may have occurred during transportation.



Installation safety

- Before the product is installed, check the product for any damage. If the product is damaged, do not install it.
- Do not install the product near heat sources (radiators, stoves, etc.).
- Keep all ventilation ducts open around the product.



Safety of use

- Make sure that the product is turned off after each use.
- If you do not use the product for a long time, disconnect it or turn off the fuse from the fuse box.
- Do not operate defective or damaged product. If any, disconnect the electricity / gas connections of the product and call the authorized service.
- **WARNING:** If the surface is cracked, switch off the appliance to avoid the possibility of electric shock.

- Do not climb on the product to reach anything or for any other reason.
- Do not use the product in situations that may affect your judgment, such as drug intake and / or alcohol use.
- Flammable objects kept in the cooking area may catch fire. Never store flammable objects in the cooking area.
- Cast iron, aluminum or cookware with damaged / rough bottom parts may lead to scratching the glass surface. When replacing cookware, always raise the containers, do not slide on the surface.
- Vapour pressure that build up due to the moisture on the hob surface or at the bottom of the pot can cause the pot to move. Therefore, make sure that the hob surface and bottom of the pots are always dry.
- This product is not suitable for use with a remote control or an external clock.



Temperature warnings

- **WARNING:** While the product is operating, exposed parts will be hot. Do

not touch the product and heating elements. Children under the age of 8 should not be brought close to the product without an adult.

- Do not place flammable / explosive materials near the product, as the edges will be hot while it is operating.
- **WARNING:** Danger of fire: Do not store items on the cooking surfaces.



Accessory use

- **WARNING:** Use only hob guards designed by the manufacturer of the cooking appliance or indicated by the manufacturer of the appliance in the instructions for use as suitable or hob guards incorporated in the appliance. The use of inappropriate guards can cause accidents.



Cooking safety

- **WARNING:** The cooking process must be observed. Short-term cooking processes must be constantly observed.
- **WARNING:** Unattended cooking on a hob with fat or oil can be dangerous and

may result in fire. NEVER try to extinguish a fire with water, but switch off the appliance and then cover flame e.g. with a lid or a fire blanket.

- Be careful when using alcohol in your food. Alcohol evaporates at high temperatures and may catch fire when exposed to hot surfaces, causing a fire.



Induction

- Hotplates are equipped with "Induction" technology. Your induction hob that provides both time and money savings must be used with pots suitable for induction cooking; otherwise hotplates will not operate. For detailed information, see the section "Pot selection".
- As induction hobs create a magnetic field, they may cause harmful impacts for people who use devices such as insulin pump or pacemaker.
- Close the hotplate from its control panel after use, do not rely on the pot sensor.
- Metal objects such as knives, forks, spoons and lids should

not be placed in the hotplate as they will get hot.

- Metal items stored in drawers under the hob may become very hot during long and intensive use. Do not store metal objects in drawers under the hob.
- Do not put electronic products such as mobile phones, tablets, computers on the induction hob. Your product may be damaged.



Maintenance and cleaning safety

- Wait for the product to cool before cleaning the product.

Hot surfaces may cause burns!

- Never wash the product by spraying or pouring water on it! There is an electric shock hazard!
- Do not clean the product with steam cleaners as this may cause electric shock.
- Salt, sugar residues on the bottom of the cookware or such particles on the glass surface can cause the glass to scratch and crack. Make sure that the bottom is clean before placing the cookware. Keep the glass ceramic surface clean.

2 Environmental Instructions

Waste regulation

Compliance with the WEEE Directive and Disposing of the Waste Product



This product complies with EU WEEE Directive (2012/19/EU). This product bears a classification symbol for waste electrical and electronic equipment (WEEE).

This product has been manufactured with high quality parts and materials which can be reused and are suitable for recycling. Do not dispose of the waste product with normal domestic and other wastes at the end of its service life. Take it to the collection center for the recycling of electrical and electronic equipment. Please consult your local authorities to learn about these collection centers.

Appropriate disposal of used appliance helps prevent potential negative consequences for the environment and human health.

Compliance with RoHS Directive:

The product you have purchased complies with EU RoHS Directive (2011/65/EU). It does not contain harmful and prohibited materials specified in the Directive.

Package information

- Packaging materials of the product are manufactured from recyclable materials in accordance with our National Environment Regulations. Do not dispose of the packaging materials together with the domestic or other wastes. Take them to the packaging material collection points designated by the local authorities.

Recommendations for energy saving

Information on energy efficiency according to EU 66/2014 can be found on the product fiche given with the product. The following suggestions will help you use your product in an ecological and energy-efficient way:

- Defrost frozen food before cooking.
- Turn off the product 5 to 10 minutes before the end time of cooking for prolonged cooking. Now you can save up to 20% electricity by using heat.
- Use pots / pans with a size and lid suitable for the hotplate. Always choose the right size pot for your meals. More than necessary energy is needed for containers of the wrong size.
- Keep hob cooking surfaces and pot bases clean. Dirt reduces the heat transfer between the cooking area and the pot base.

3 Your product

Product introduction

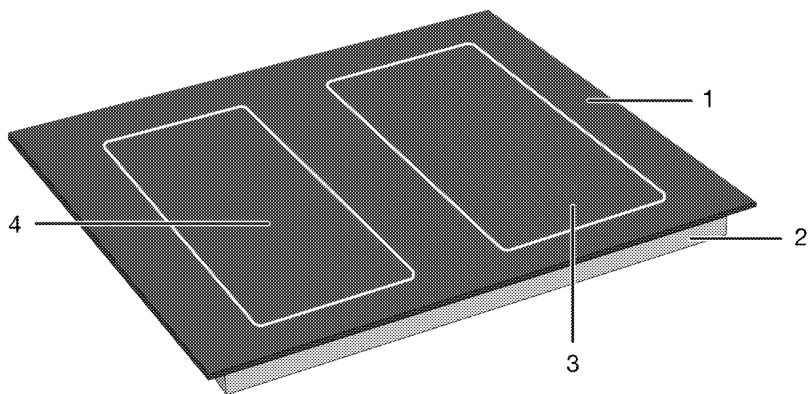

- 1 Glass cooking surface
- 2 Lower housing
- 3 Induction cooking zone
- 4 Induction cooking zone

Product control panel introduction and usage

In this section, you can find the overview and basic uses of the product's control panel. There may be differences in images and some features depending on the type of product.

Hob control

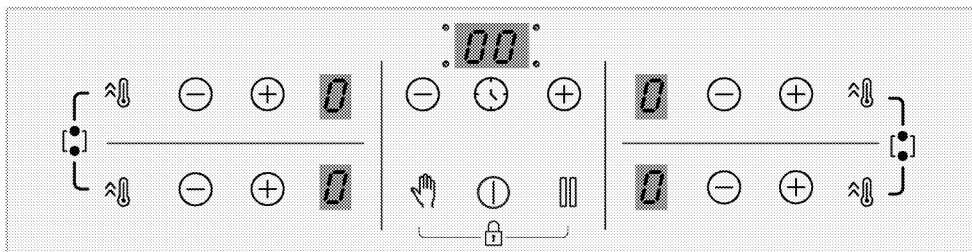

Keys

- ⓘ : On/Off key
- 🕒 : Timer key
- 🔥 : Quick Heating key/High power setting (booster) key
- 👉 : Cleaning lock key
- ⏸ : Stop key
- ⊕ : Increase key
- ⊖ : Decrease key

Symbols

- 🔥 : Wide surface cooking zone combination symbol
- 🔒 : Key lock symbol

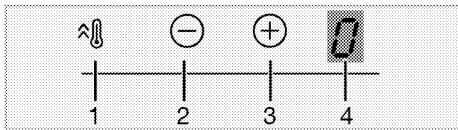
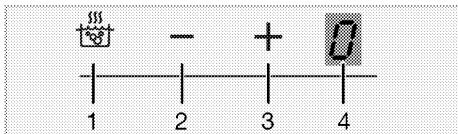

Cooking zone display

- 1 Quick Heating key/High power setting (booster) key
- 2 Temperature decrease key
- 3 Temperature increase key
- 4 Temperature indicator of the relevant cooking zone

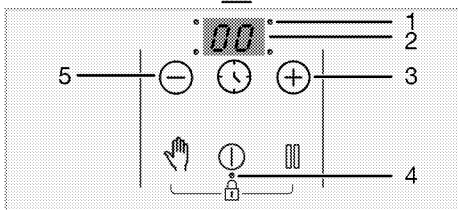
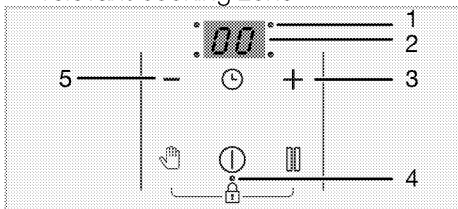

Timer indicator

- 1 Operation point LED for the timer
- 2 Timer indicator
- 3 Timer increase key
- 4 Operation point LED for the Key lock/Child lock
- 5 Timer decrease key

General information on hob

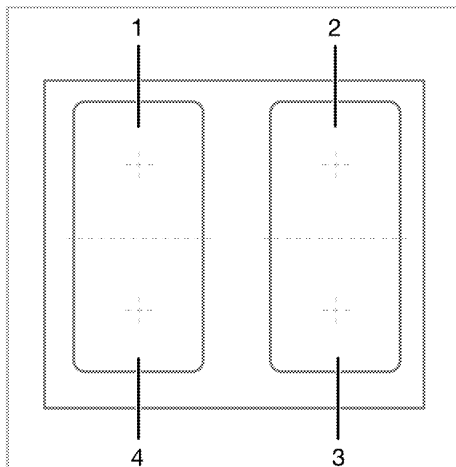

- 1 Rear left - Induction cooking zone
- 2 Rear right - Induction cooking zone
- 3 Front right - Induction cooking zone
- 4 Front left - Induction cooking zone

Your hob is equipped with hob cooking surfaces with wide surfaces (Flexi surfaces). You may operate this cooking surface as individual hobs independent from each other. You may activate the combination function for these cooking zones and transform them to a single cooking surface for cooking operations with your large cooking pots. Using proper pots for these cooking zones and the combination function are described in the "How to use the hob" section.

Technical specifications

General specifications

Product external dimensions (height/width/depth)	52 mm*/580 mm/510 mm (For models that come with mounting springs and sealing gasket attached to the product, consider the width and depth measurements as 10 mm more than these measurements.)
Hob installation dimensions (width/depth)	560 (+2) mm /490 (+2) mm
Voltage / frequency	1N ~ 220-240 V/ 2N ~ 380-415 V ~ 60 Hz
Cable type and cross section used / suitable for use in the product	min. H05V2V2-F 5 x 1,5 mm ²
Total power consumption	max. 7200 W

Burners

Rear left	Induction cooking zone
Dimension	180 mm
Power	2000W / Booster: 2300 W
Front left	Induction cooking zone
Dimension	180 mm
Power	2000W / Booster: 2300 W
Front right	Induction cooking zone
Dimension	180 mm
Power	2000W / Booster: 2300 W
Rear right	Induction cooking zone
Dimension	180 mm
Power	2000W / Booster: 2300 W

* The height of the hob specified in the technical table is the base cover height of the product.



Technical specifications may be changed without prior notice to improve the quality of the product.



Figures in this manual are schematic and may not exactly match your product.



Values stated on the product labels or in the documentation accompanying it are obtained in laboratory conditions in accordance with relevant standards. Depending on operational and environmental conditions of the product, these values may vary.

4 First use

Before you start using your product, it is recommended to do the following in the following sections.

First cleaning

1. Remove all packaging materials.
2. Wipe the surfaces of the product with a wet cloth or sponge and dry with a cloth.

NOTICE The surface might get damaged by some detergents or cleaning materials. Do not use aggressive detergents, cleaning powders/creams or any sharp objects during cleaning.

NOTICE Smoke and smell may emit for a couple of hours during the initial operation. This is quite normal. Ensure that the room is well ventilated to remove the smoke and smell. Avoid directly inhaling the smoke and the smell that emits.

5 How to use the hob

General information on hob usage

General warnings

- Do not let any objects to fall on the hob. Even small objects such as saltshakers may damage the hob. Do not use cracked hobs. Water may seep through these cracks and cause a short circuit. If the surface is damaged in any way (e.g. visible cracks), turn off the fuse first, then call the authorized service to unplug the product to reduce the risk of electric shock.
- Do not use unbalanced and easily tilting pots/pans on the hob.
- Do not heat the pots/pans and pots empty. The pots and the appliance may be damaged.
- Always turn off the hob's burners after each use.
- You shall damage the appliance if you operate the hobs without any pot or pots/pans. Always turn off the hobs after each operation.
- After each use the cooking surface will be hot, so do not put the plastic pots/pans on the cooking surface. Clean such material on the surface immediately.
- Sudden temperature changes on the glass cooking surface may cause damage, be careful not to spill cold liquids during cooking.
- Put a sufficient amount of food in pots and pans. Thus, you can prevent food from pouring forth out of the pots/pans and will not need to clean unnecessarily.
- Do not place the covers of pots and pans on burners/zones.

- Place the pots by centering them on the burners/zones. If you wish to place a pot on a different burner/zone, do not slide it towards the desired burner; rather, lift it first and then put it on the other burner.

Operating principle of the induction hob

Induction hob is like an open circuit. The circuit completes when a cooking pots/pans suitable for induction cooking is placed on it and an electronic system below the glass surface generates a magnetic field. The metal base of the pots/pans is heated by taking energy from this magnetic field. Thus, the heat is not generated on the surface of the hob, but directly on the pots/pans above it. Glass surface is heated with the heat of the cooking pots/pans.

Advantages of cooking with induction

Induction hobs offer some advantages as the heat is transferred directly to the cooking pots/pans.

- Foods that overflow during cooking do not burn rapidly as the glass cooking surface is not heated directly. It is cleaned more easily.
- Cooking shall be faster as the heat is generated directly on the cooking pots/pans. Thus, it saves time and energy with respect to other hob types.
- As the heat is given directly to the cooking pots/pans, there is no heat loss, and it provides a more efficient cooking.
- The fact that the heat transfer stops and the cooking surface is not heated directly when the cooking pots/pans is removed from the cooking surface provides a safer use against possible accidents while cooking.

For a safe operation:

- Do not select high heating levels when using non-sticking cooking pots/pans coated with little amount of oil or used without oil (teflon type).
- Do not use glass cooking surface as a surface where you can place something on it or as a cutting surface.
- Do not place metal objects such as cutlery or pot lids on your hob as they may get hot.
- Never use aluminium foil for cooking. Never place food wrapped in aluminium foil on the induction zone.
- Keep magnetic objects such as credit cards or tapes away from the hob while it is operating.
- If there is an oven under your hob and it is being operated, the sensors on the hob may reduce the cooking level or turn off the hob.
- Your hob has an automatic shut-off system. Detailed information about this system is provided in the following sections. However, if you use thin based pots for your cooking, these pots shall heat up very quickly and the bottom of the pan may melt and damage the cooking surface and the appliance before the automatic shut-off system is activated.

Cooking pots/pans

You shall use ferromagnetic, quality cooking pots/pans which bear a label or warning that it is compatible for induction cooking only with your induction hob. Generally, the higher the iron content, the better the cooking pots/pans shall perform. The base diameter of the cooking pots/pans shall match the induction zone. Suggested dimensions are listed below.

Suitable pots/pans:

- Cast iron pots/pans
- Enamelled steel pots/pans

- Steel and stainless steel pots/pans (with label or warning indicating that it is induction compatible)

Unsuitable pots/pans:

- Aluminium pots/pans
- Copper pots/pans
- Brass pots/pans
- Glass pots/pans
- Pottery
- Ceramic and porcelain

Recommendations:

- Use flat bottomed cooking pots/pans only. Do not use pots/pans with convex or concave bases.

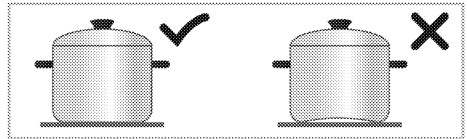

- Use cooking pots/pans with thick, processed bases only. If you use thin based pots, these pots shall heat up very quickly and the bottom of the pan may melt and damage the cooking surface and the appliance before the automatic shut-off system is activated. Sharp edges may cause scratches on the surface.

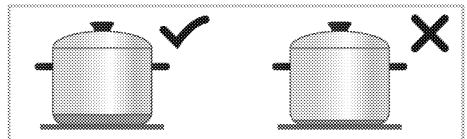

- The bases of some cooking pots/pans have a smaller ferromagnetic field than its true diameter. Only this area is heated by the hob. Therefore, the heat is not evenly distributed and the cooking performance is decreased. Moreover, such cooking pots/pans may not be detected by large induction hobs. Thus, the cooking hob shall be selected according to the size of the ferromagnetic field.

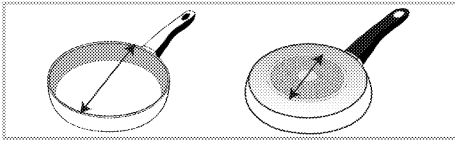

- Some cooking pots/pans have a base that contains non-ferromagnetic materials such as aluminium. These types of cooking pots/pans may not heat adequately or may not be detected by the induction hob at all. In some cases, a bad pots/pans warning may appear.

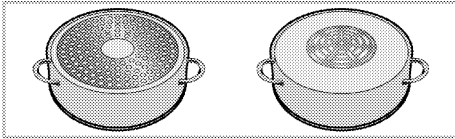

- i** Equal distribution of the cookware on the right and left and center hobs for the selection of hobs affects the cooking performance positively while cooking multiple meals on the induction hobs.

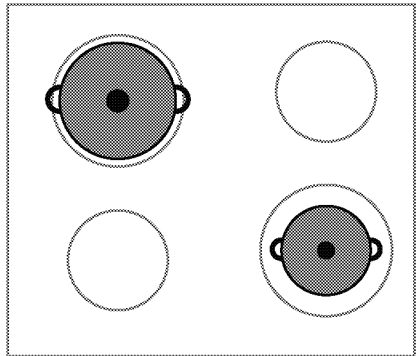
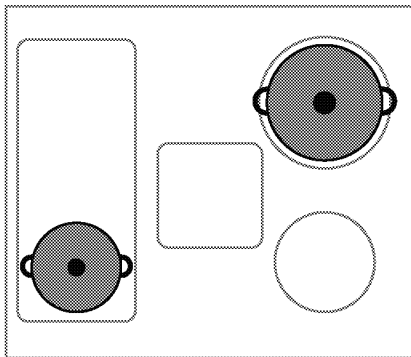

Cooking pots/pans test

Test whether your pot is compatible with cooking with an induction hob using the methods below.

- It is compatible if the base of your pot holds a magnet.
- It is compatible if "E" does not flash when you place your pot on the induction hob and turn on the hob.

Recommended cooking pots/pans sizes

Diameter of cooking zone - mm	Pot diameter - mm
145	min. 100 - max 145
180	min. 100 - max 180
210	min. 140 - max 210
240	min. 140 - max 240
280	min. 125 - max 280
320	min. 125 - max 320
Cooking zone with wide (flexi) surface	width 230 - length 390

The detection of cooking pots/pans by the induction hobs depend on the diameter and material of the ferromagnetic in the base of the pots/pans. To ensure detection of the cooking pots/pans and achieve an efficient cooking, the cooking pots/pans shall be selected as per the size of your hob. The cooking pots/pans sizes recommended for hob sizes are given above.

Boiling behavior may vary depending on the pot types, size of the pot and size of

the cooking zone. For a more homogenous boiling behavior, a one step larger cooking zone might be used. To use a larger cooking zone does not cause wasting of energy at induction hobs, because the heat is only created in the relevant pot area.

Cooking zone with wide surface (flexi)

Your hob is equipped with hob cooking surfaces with wide surfaces (Flexi surfaces). You may operate this cooking surface as individual hobs independent from each other for your smaller cooking pots/pans. You may activate the combination function for these cooking zones and transform them to a single cooking surface for cooking operations with your large cooking pots.

As two independent cooking zones

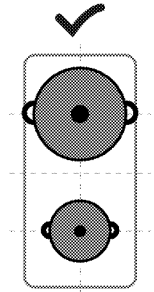

Cooking zones with wide surface have two cooking zones, as front and rear. You may use these zones as two independent cooking zones for different temperature levels with two different cooking pots/pans. Place the cooking pots/pans by centering the separate cooking zones.

As two independent cooking zones

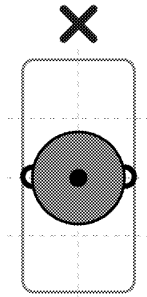

For cooking operation with a single cooking pot/pan, place it in the centre of the front or rear cooking zone. Do not place the cooking pot/pan at the centre of the cooking zone.

As a single cooking zone

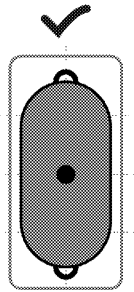





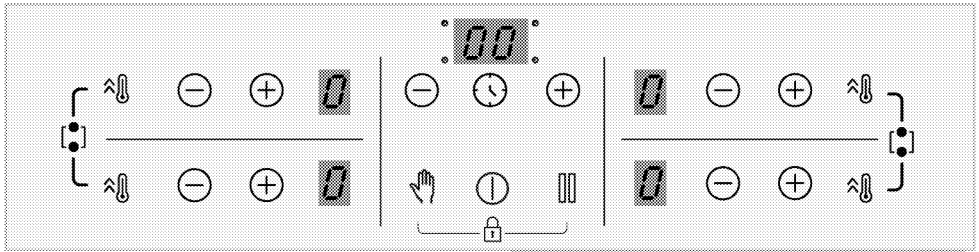

For cooking operations on large cooking pots/pans, place the pots/pans so that it covers the centres of both cooking zones and that it is centred on the cooking zone.



Control panel



Keys

-  : On/Off key
-  : Timer key
-  : Quick Heating key/High power setting (booster) key
-  : Cleaning lock key
-  : Stop key
-  : Increase key
-  : Decrease key

Symbols

-  : Wide surface cooking zone combination symbol
-  : Key lock symbol

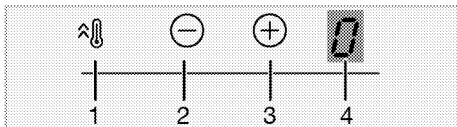
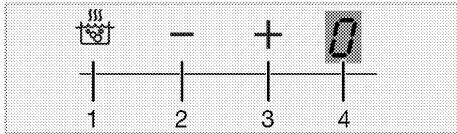

Cooking zone display

- 1 Quick Heating key/High power setting (booster) key
- 2 Temperature decrease key
- 3 Temperature increase key
- 4 Temperature indicator of the relevant cooking zone

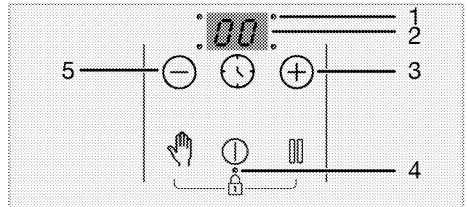
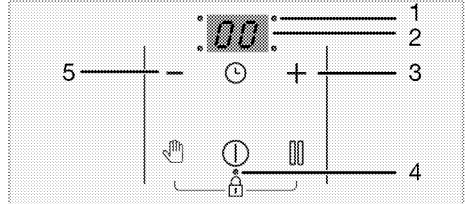

Timer indicator

- 1 Operation point LED for the timer
- 2 Timer indicator
- 3 Timer increase key
- 4 Operation point LED for the Key lock/Child lock
- 5 Timer decrease key

General warnings for the control panel

- i** This product is controlled with a touch control panel. Each operation you make on your touch control panel will be confirmed by an audible signal.
- i** Always keep the control panel clean and dry. Having damp and soiled surface may cause problems in the functions.
- i** The hob will automatically return to Standby mode if no operation is performed within 10 seconds..
- i** The product will switch itself off for safety reasons if no key is touched for a long time.

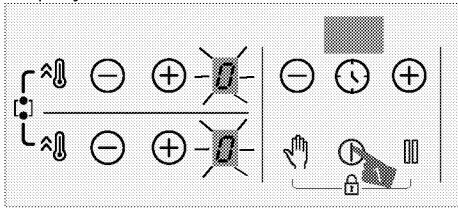

Switching on the hob:

1. Switch on the hob by touching  key. "0" appears on all the cooking zones display.







Switching off the cooking zone:

An active cooking zone can be switched off in 3 different ways:

1. **By touching the  key**
Touch the  key.
2. **By dropping the temperature to "0" level;**
You can switch off the cooking zone by adjusting the temperature setting to "0" level.
3. **By using the switching off function on the timer for the desired cooking zone;**
When the time is over, the timer will switch off the cooking zone assigned to

it. "0" or "00" will appear on related display.
When the time is over, an audible alarm will sound. Touch any key on the control panel to silence the audible alarm.

4. **By touching the zone / keys simultaneously for the desired cooking zone;**
You can switch off the related cooking zone by touching its / keys simultaneously.



- i** If "H" or "h" is on after the cooking zone has been switched off, it means that the cooking zone is still hot. Do not touch the cooking zones.

Residual heat indicator

If "H" symbol is flashing on the cooking zone display, it means that the hob is still hot and can be used to keep a small amount of food warm. The symbol will soon turn to "h" symbol, which means it is less hot.

- i** When the electricity is cut off, residual heat indicator will not light up and does not warn the user against hot cooking zones.

Adjusting the temperature level

1. Switch on the hob by touching  key.
2. Adjust the desired temperature level by touching the zone / keys.

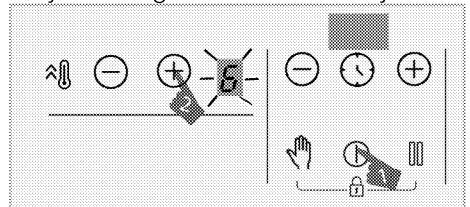



» The relevant cooking zone will start to operate at the set temperature level.

i The outer section of the 280 mm induction hob cooking zone (if your product is equipped with a 280 mm induction hob cooking zone) is activated only when a saucepan large enough to cover the cooking zone is placed on the cooking zone and the temperature is set to a level higher than 8.

High power setting (BOOSTER)

You can use booster function for rapid heating. However, this function is not recommended for cooking a long time. Booster function may not be available in all cooking zones.

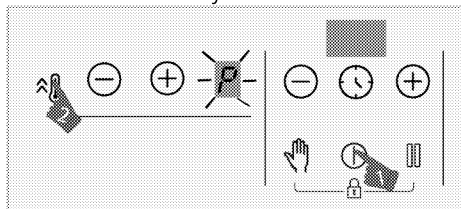

Selecting the high power setting (BOOSTER):

1. Switch on the hob by touching  key.
2. Touch the  key of related zone.



» Selected cooking zone will operate with maximum power and "P" symbol will appear on the cooking zone display. Cooking zone goes out of booster and continues to operate at level "9".

Switching off the high power setting (BOOSTER) prematurely:

You can switch off the high power setting anytime you want by touching the  or  key.



Cooking zone goes out of booster and continues to operate at level "9".

Working principle of 2 zones which are located same vertical direction:

If one zone is set to level booster and than the other zone, which is located

same vertical direction set to bigger than level 6 (7, 8 and 9), first zone drops to level 9 and the other zone can be set bigger than level 6 (7, 8 and 9). If the second zone is set to level booster, first zone drops to level 6.

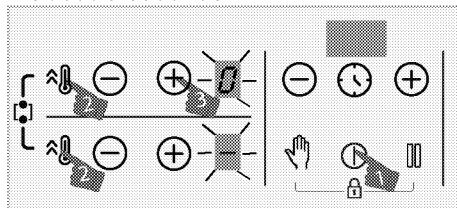

Turning on the wide surface cooking zone

1. Touch  to turn on the hob.
2. To turn on the wide surface cooking zone, keep  key of both cooking zones pressed simultaneously for about 3 seconds.



» "0" will appear on the display of the rear-left cooking zone.  will appear on the display of the front-left cooking zone and the wide surface cooking zone will be activated.

3. Touch  keys of the rear-left cooking zone to set the temperature between "0" and "9".

i Once the wide surface cooking zone has been activated, the temperature can be set with  keys of the rear-left cooking zone. You cannot set the temperature using  keys of the front-left cooking zone.

i Wide surface left cooking zones are explained as an example. If there is a wide surface cooking zone also on the right-hand side of the hob, the same instructions apply to the said cooking zone.

» Cooking zone starts to run.

Turning on the wide surface cooking zone while one or both of the left cooking zones are running

While one or both of the left cooking zones are running, you can combine both cooking zones by activating the wide surface cooking zone. Thus, you can utilise a wider cooking zone just at the same level.

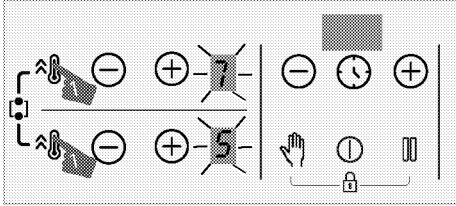

1. To turn on the wide surface cooking zone while one or two of the left cooking zones are active, keep key of both cooking zones pressed simultaneously for about 3 seconds.

» Temperature value of the last selected cooking zone will appear on the display of the rear-left cooking zone and the wide surface cooking zone will be activated.

» Combined cooking zones will continue operating with the temperature and the timer (if available) value of the left cooking zone you have selected. Value of the left cooking zone that was set first before combining the cooking zones will be cancelled.

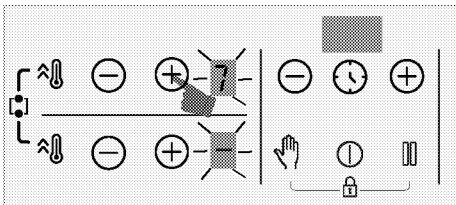

» To change the temperature, touch / keys of the rear-left cooking zone and set the desired temperature.

i If you touch key of the left cooking zone while the wide surface cooking zone is active, the cooking zones will operate at booster level.

Turning off the wide surface cooking zones

Wide surface cooking zone can be turned off in 4 different ways:

1. **By dropping the temperature to "0" level**

You can turn the wide surface cooking zone off by dropping the temperature level to "0".

2. **By using the switching off function on the timer for the wide surface cooking zone**

When the time is over, the timer will turn off the wide surface cooking zone. **0** will appear on the left cooking zone display and **00** will appear on the timer display.

3. **By touching / keys of any of the left cooking zones simultaneously**

If you touch / keys of any of the left cooking zones simultaneously, the cooking zones will be separated and turned off.

4. **By pressing key of both cooking zones simultaneously for about 3 seconds**

The cooking zones will turn off if you press keys of both cooking zones simultaneously for about 3 seconds.

Cleaning lock

The cleaning lock prevents operation of all keys on the control panel for 20 seconds while the hob is switched on to allow the user to make a short cleaning. Product will not draw any power throughout this time.



Activating the cleaning lock

1. Touch and hold the key until a **single signal sound** is heard when any cooking zone is switched on.

A countdown begins from 20 on the timer display of the hob. None of the keys on the panel will function except the  key throughout this period.

Deactivating the cleaning lock



You do not have to press any key to deactivate the cleaning lock. The hob will give a signal audio signal after 20 seconds and the cleaning lock will automatically be deactivated.

 If you want to deactivate the cleaning lock earlier, touch and hold the  key until **two signal sound** is heard.

Child Lock

When the cooking zones are switched off, you can protect the hob with the child lock to prevent children from switching on the cooking zones. You can activate or deactivate the child lock only when the cooking zones are switched off (in the standby mode).



Activating the child lock

1. Touch and hold the both  and  keys simultaneously until **a single signal sound** is heard when the hob is in the standby mode.

The child lock will be activated. "L" will be displayed on all cooking zones display for a while and the decimal point of the  key will be turned on.

 If any key is pressed when the child lock function is active, two signal sound will be heard and "L" will blink on all cooking zones display.

Deactivating the child lock

1. Touch and hold the both  and  keys simultaneously until **two signal sound** is heard when the child lock is active.
» The child lock function will be deactivated. "L" will blink on all cooking



zones display and the light of the  key goes out.

Key Lock



You can activate the key lock in order to prevent the functions from being changed by mistake while the hob is operating.

 Key lock will be cancelled in case of power failure.



Activating the key lock

1. Touch and hold the both  and  keys simultaneously until **a single signal sound** is heard.

The Key lock will be activated and the decimal point of the  key will be turned on after blinking.

 You can activate the key lock in the operation mode only. Only the  key will be functional when the key lock is active. When you touch any other button, the decimal point of the  key will blink to indicate that the key lock is active. If you switch the hob off when the keys are locked, you must deactivate the key lock in order to be able to switch on the hob again. If you touch any button without deactivating key lock, "L" will blink on all cooking zones display to indicate that the key lock is active. Deactivate the key lock to turn on the hob again.

Deactivating the key lock



1. Touch the both  and  keys simultaneously until **two signal sound** is heard when the key lock is active.
» The light of the  key will go out and the control panel will get unlocked.

Timer function



This function makes it easier for you to cook. You will not have to watch the hob for the whole cooking period. The

cooking zone will be switched off automatically at the end of the time period you have set.

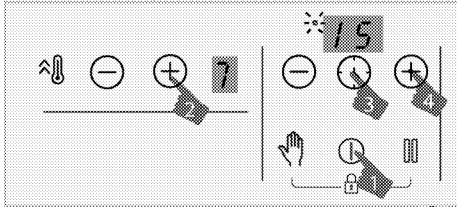

Activating the timer

1. Switch on the hob by touching  key.
2. Adjust the desired temperature level by touching the zone / keys.



3. Activate the timer by touching the  key. "00" symbol and decimal point of selected zone will blink on timer display.
4. Set the desired duration by touching the timer / keys.
5. After 10 second, the setting will be activated. Decimal point of selected zone will blink on timer display.
6. In order to set the timers of the other cooking zones, repeat the process explained above.

 If more than one timer value are set to different zones, the zone timer which has minimum timer value is displayed on the timer display and the decimal point for that zone blinks. The decimal points of the other zones illuminate continuously.

 You can see the remaining cooking time by touching the  key of all cooking zone. For each touching, different zone timer value is displayed. Finally, the minimum timer value is displayed again.

 Timer cannot be set without selecting the cooking zone and its temperature value

 The timer can only be set for the operating cooking zones.



Deactivating the timer

Once the set time is over, the hob will be switched off automatically and give audible signal sound. Press any key to silence the audible signal sound. If you do not press any key, the signal sound will be cancel after a few minutes.



Deactivating the timers earlier

If you deactivate the timer earlier, the hob will keep on operating at the set temperature until it is switched off. You can deactivate the timer earlier in two different ways:

Deactivating the timer for related zone by dropping its value to "00":

1. Touch the timer / keys until "00" appears on the display of the cooking zone whose timer is active.
 - » Decimal point symbol of the related zone will permanently goes off and the timer will be canceled.

Deactivating the timer for related zone by touching the related zone / keys simultaneously:



1. Touch the related zone / keys simultaneously.
 - » Decimal point symbol of the related zone will permanently goes off and the timer will be canceled.

 After this step, the temperature level of the related zone will be "0" also with the timer level.

Stop function

You can decrease operating temperature level of the cooking zones to minimum level (level 1) by means of this function.

i If the timer is set for any cooking zone, it will continue operating during stoppage.







1. Touch the  key when any of the cooking zones is operating. All operating cooking zones will operate at minimum level (level 1). "■" symbol will appear on the display of the active cooking zones.
2. Touch the  key again to reoperate all cooking zones with their previous settings.

Power management function



Your appliance is equipped with a power management function. You may change the total power that may be drawn by the hob with this function. There are 8 levels available for the power management function. Power management function - Total power levels that may be set

Power management display indicator	Total power
25	2,5 kW
30	3 kW
36	3,6 kW
44	4,4 kW
54	5,4 kW
57	5,7 kW
67	6,7 kW
72	7,2 kW

To change the total power;

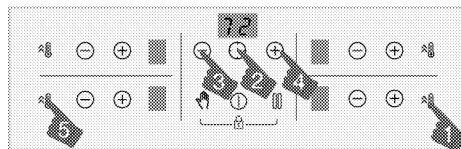
1. Turn the hob on by touching the  key. Turn off the hob on by touching the  again.
2. Then touch respectively the  key of the right front zone, the  key, the timer  key, the timer  key, and finally the left front zone  key.



3. The power management level set is displayed on the timer display.
4. Touch the  key to switch between levels and set the total power value you want to set.
5. Confirm the setting by touching the  key and turn off the hob. Total power value you have set shall be activated.

i The temperature levels you may assign to the hobs may vary as per the total power level set. The temperature level provided to the hob be reduced automatically as per the power setting to be performed by the hob. This is not an error.

i If a key other than the specified sequence is touched while changing the power level, the setting cannot be made. You have to repeat the steps from the beginning to make the setting.

Using induction cooking zones safely and efficiently

Operating principles: Induction hob directly heats the cooking vessel as a matter of principle. Therefore, it has a lot of advantages as compared with other hob types. It operates more efficiently and the hob surface is colder. Your induction hob is equipped with superior safety systems that will provide you maximum safe usage.

i Your hob can be equipped with induction cooking zones with a diameter of 145, 180, 210 and 280 mm depending on the model. Each cooking zone automatically detects the vessel placed on it thanks to the induction feature. Energy is generated only where the vessel comes into contact with the cooking zone and thus, minimum energy consumption is achieved.

i The product might start-stop when it is operating on levels from 1 to 7, especially with cookware with a small diameter and when water-oil is little. This is not a fault.

Automatic turning off system

The hob control has an automatic turn off system. If one or more hob zone(s) are left on, the hob zone turns off automatically after a while (See Table-1). In case of a timer assigned to the hob, the timer screen is turned off then, too.

The time limit for automatic turn off depends on the selected temperature level. Maximum operating period is applied for this temperature level.

The hob zone may be operated by the user again after it is turned off automatically as described above.

Table-1: Automatic turning off periods

Temperature level	Automatic turning off periods - hours
0	0
1	6
2	6
3	5
4	5
5	4
6	1,5
7	1,5

Temperature level	Automatic turning off periods - hours
8	1,5
9	30 minutes
P (Booster)	10 minutes (*)
(*) The hob will drop to level 9 after 10 minutes	

Overheating protection

Your hob is equipped with some sensors which provide protection against overheating. Following may be observed in case of overheating:

- Operating cooking zone may get switched off.
- Selected level may drop to level 7 from higher level.

Overflow safety system

Your hob is equipped with an overflow safety system. If there is any overflow that spills onto the control panel, the system will cut the power connection immediately and switch off your hob. "E" warning appears on the indicator during this period.

Precise power setting

Induction hob reacts the commands immediately as an operating principle. It changes the power settings very fast. Thus, you can prevent a cooking pot (containing water, milk and etc.) from overflowing even if it was just about to overflow.

i If the surface of the touch control panel is exposed to intense vapor, entire control system may become deactivated and give error signal.

i Keep the surface of the touch control panel clean. Erroneous operation may be observed.

6 General information about cooking

This section describes tips on preparing and cooking your food.

General warnings about cooking with hob

- Never fill the pan with oil more than one third of it. Do not leave the hob unattended when heating oil. Overheated oils bring risk of fire.
Never attempt to extinguish a possible fire with water! When oil catches fire, cover it with a fire blanket or damp cloth. Turn off the hob if it is safe to do so and call the fire department.

- Before frying foods, always remove their excess water and put them inside the heated oil slowly. Make sure that frozen foods are defrosted before frying.
- When heating oil, make sure that the pot you use is dry and keep its lid open.
- For recommendations on cooking with power saving, refer to the “Environmental Instructions” section.
- The cooking temperature and time values given for foods may vary depending on the recipe and amount. For this reason, these values are given as ranges.

7 Maintenance and care

General cleaning information

⚠ General warnings

- Wait for the product to cool before cleaning the product. Hot surfaces may cause burns!
- Do not apply the detergents directly on the hot surfaces. This may cause a permanent stains.
- The appliance shall be thoroughly cleaned and dried after each operation. Thus, food residues shall be easily cleaned and these residues shall be prevented from burning when the appliance is used again later. Thus, the service life of the appliance extends and frequently faced problems are decreased.
- Do not use steam cleaning products for cleaning.
- Some detergents or cleaning agents may damage the surface. Do not use abrasive detergents, cleaning powders, cleaning creams, descalers or sharp objects during cleaning.
- There is no need for a special cleaning agent for cleaning after each use. Clean the appliance using dish soap, warm water and a soft cloth or sponge and dry with a dry microfiber cloth.
- Be sure to completely wipe off any remaining liquid after cleaning and immediately clean any food splashing around during cooking.
- Do not wash any component of your appliance in a dishwasher.

For the hob:

- Acidic dirt such as milk, tomato paste and oil may cause permanent stains on the hobs and components of the burners/hotplates, clean any overflow

fluids immediately after cooling down the hob by turning it off.

Inox and stainless surfaces

- Do not use acid or chlorine-containing cleaning agents to clean stainless or inox surfaces and handles.
- Stainless or inox surface may change colour in time. This is normal. After each operation, clean with a detergent suitable for the stainless or inox surface.
- Clean with a soft soapy cloth and liquid (non-scratching) detergent suitable for inox surfaces, taking care to wipe in one direction.
- Remove lime, oil, starch, milk and protein stains on the inox-stainless and glass surfaces immediately without waiting. Stains may rust under long periods of time.

Glass surfaces

- When cleaning glass surfaces, do not use hard metal scrapers and abrasive cleaning materials. They can damage the glass surface.
- Clean the appliance using dishwashing detergent, warm water and a microfiber cloth specific for glass surfaces and dry it with a dry microfiber cloth.
- If there is residual detergent after cleaning, wipe it with cold water and dry with a clean and dry microfiber cloth. Residual detergent residue may damage the glass surface next time.
- Under no circumstances should the dried-up residue on the glass surface be cleaned off with serrated knives, wire wool or similar scratching tools.
- You can remove the calcium stains (yellow stains) on the glass surface with the commercially available

descaling agent, with a descaling agent such as vinegar or lemon juice.

- If the surface is heavily soiled, apply the cleaning agent on the stain with a sponge and wait a long time for it to work properly. Then clean the glass surface with a wet cloth.
- Discolorations and stains on the glass surface are normal and not defects.

Plastic parts and painted surfaces

- Clean plastic parts and painted surfaces using dishwashing detergent, warm water and a soft cloth or sponge and dry them with a dry cloth.
- Do not use hard metal scrapers and abrasive cleaners. It may damage the surfaces.
- Ensure that the joints of the components of the appliance are not left as damp and with detergent. Otherwise, corrosion may occur on these joints.

Cleaning the hob

Glass cooking surface

Follow the cleaning steps described for the glass surfaces in the "General cleaning information" section for the cleaning of glass cooking surface. You may complete your cleaning as per the information below for special cases.

- Sugar-based foods such as dark cream, starch and syrup should be

cleaned immediately, without waiting for the surface to cool. Otherwise, the glass cooking surface may be permanently damaged.

- Do not use cleaning agents for cleaning operations you perform while the hob is hot, otherwise permanent stains may occur.

Cleaning the control panel

- When cleaning the panels with knob control, wipe the panel and knobss with a damp soft cloth and dry with a dry cloth. Do not remove the knobs and gaskets underneath to clean the control panel. The control panel and knobs may be damaged.
- While cleaning the inox panels with knob control, do not use inox cleaning agents around the knobs. The indicators around the knobs may be deleted.
- Clean the touch control panels with a damp soft cloth and dry with a dry cloth. If your product has a key lock feature, set the key lock before performing control panel cleaning. Otherwise, incorrect detection may occur on the keys.

8 Troubleshooting

Consult the Authorised Service Agent or technician with license or the dealer where you have purchased the product if you cannot remedy the trouble although you have implemented the instructions in this section. Never attempt to repair a defective product yourself.

Product does not operate.

- The mains fuse is defective or has tripped. >>> *Check fuses in the fuse box. If necessary, replace or reset them.*
- Product is not plugged into the (grounded) socket. >>> *Check the plug connection.*
- Buttons/knobs/keys on the control panel do not function. >>> *If your product equipped with key lock function, keylock may be enabled. Please disable it.*
- If the display does not light up when you switch the hob on again. >>> *Disconnect the appliance at the circuit breaker. Wait minimum 20 seconds and then reconnect it.*
- Overheat protection is active. >>> *Allow your hob to cool down.*
- The cooking pot is not suitable. >>> *Check your pot.*

"L" symbol appears on the cooking zone display.

- You have not placed the pot on the active cooking zone. >>> **Check if there is a pot on the cooking zone.**
- Your pot is not compatible with induction cooking. >>> *Check if your cooking pot is compatible with induction hob.*
- The cooking pot is not centered properly or the bottom surface of the pot is not wide enough for the cooking zone. >>> *Choose a pot wide enough and center the pot on the cooking zone properly.*
- Cooking pot or cooking zone is overheated. >>> *Allow them to cool down.*

Selected cooking zone suddenly turns off during operation.

- Cooking time for the selected cooking zone may be over. >>> *You may set a new cooking time or finish cooking.*
- Overheat protection is active. >>> *Allow your hob to cool down.*
- An object may be covering the touch control panel. >>> *Remove the object on the panel.*

The pot does not get warm even if the cooking zone is on.

- Your pot is not compatible with induction cooking. >>> *Check if your cooking pot is compatible with induction hob.*
- The cooking pot is not centered properly or the bottom surface of the pot is not wide enough for the cooking zone. >>> *Choose a pot wide enough and center the pot on the cooking zone properly.*

Cooling fan continues operating although the hob is turned off.

- This is not a fault. Cooling fan will continue operating until the electronics in the hob cools down to a suitable temperature.

Noise from the cooker during cooking

Some sounds may be heard from the cooker while cooking. These sounds are due to the composition of the cooking vessel. These sounds are normal, they are not a malfunction and they are a part of induction technology.

Possible noises and reasons

- **Fan noise:** The cooker is equipped with a fan that activates automatically according to the temperature of the appliance. The fan has various operating levels and operates at different levels as per the temperature.
- **Lower buzz like the operating noise of a transformer:** This is due to the nature of the induction technology. As the heat is transmitted directly to the base of the cooking vessel, such buzz sounds may be heard as per the material of the cooking vessel. Thus, different noises may be heard with different cookware.
- **Cracking noise:** The reason of this is the structure and material of the base of the cooking vessel. A cracking sound may be heard if the cooking vessel is made of various layers with different materials.
- **Whining noise:** A whining sound may be heard when two cooking zones on the same side of the cooker are used to cook with different cooking levels.

Error codes/reasons and possible solutions - For hob

Error codes	Error reasons	Possible solutions
E 22 E 26	Induction hob is overheated.	Turn the induction cooker off and wait until it is cooled down. The error shall be resolved when temperature of the hob comes down below the limits.
E 46	One or more keys are kept pressed for more than 10 seconds. An object is left on the control panel or the control is exposed to vapour.	The problem shall be resolved when you remove your hand from the hob. The problem shall be resolved when the control panel is cleaned.
E 47	A pot suitable for induction heating is not used.	The error shall be resolved when a pot suitable for induction heating is used.
E 1 - E 15	Communication error on induction hob.	Turn the induction hob off and operate again after 30 seconds. Contact the authorized dealership if the issue is resumed.
E 16 - E 21	Temperature sensor error on induction hob.	Turn the induction hob off and operate again after 30 seconds. Contact the authorized dealership if the issue is resumed.

Error codes	Error reasons	Possible solutions
E 23 E 24	Software error on induction hob.	Turn the induction hob off and operate again after 30 seconds. Contact the authorized dealership if the issue is resumed.
E 25	Fan operation error on induction hob.	Turn the induction hob off and operate again after 30 seconds. Contact the authorized dealership if the issue is resumed.
E 31 - E 45	Electronic board hardware error on induction hob.	Turn the induction hob off and operate again after 30 seconds. Contact the authorized dealership if the issue is resumed.
E 48 E 49 E 51	Sensor error on induction hob.	Sensor equipment shall be rendered compatible for the operating conditions. Contact the authorized dealership if the issue is resumed.
E 52 - E 57	High temperature error on induction hob.	Turn the induction hob off and wait until it is cooled down. The error shall be resolved when temperature of the sensor comes down below the limits. Contact the authorized dealership if the issue is resumed.