

Kettle

User Manual

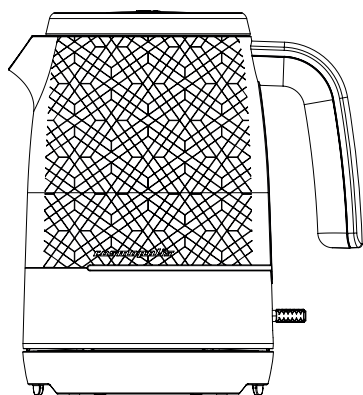

WKM 8306 B
WKM 8306 T
WKM 8306 W

EN

01M-8816343200-2819-02

beko

CONTENTS

ENGLISH

07-13

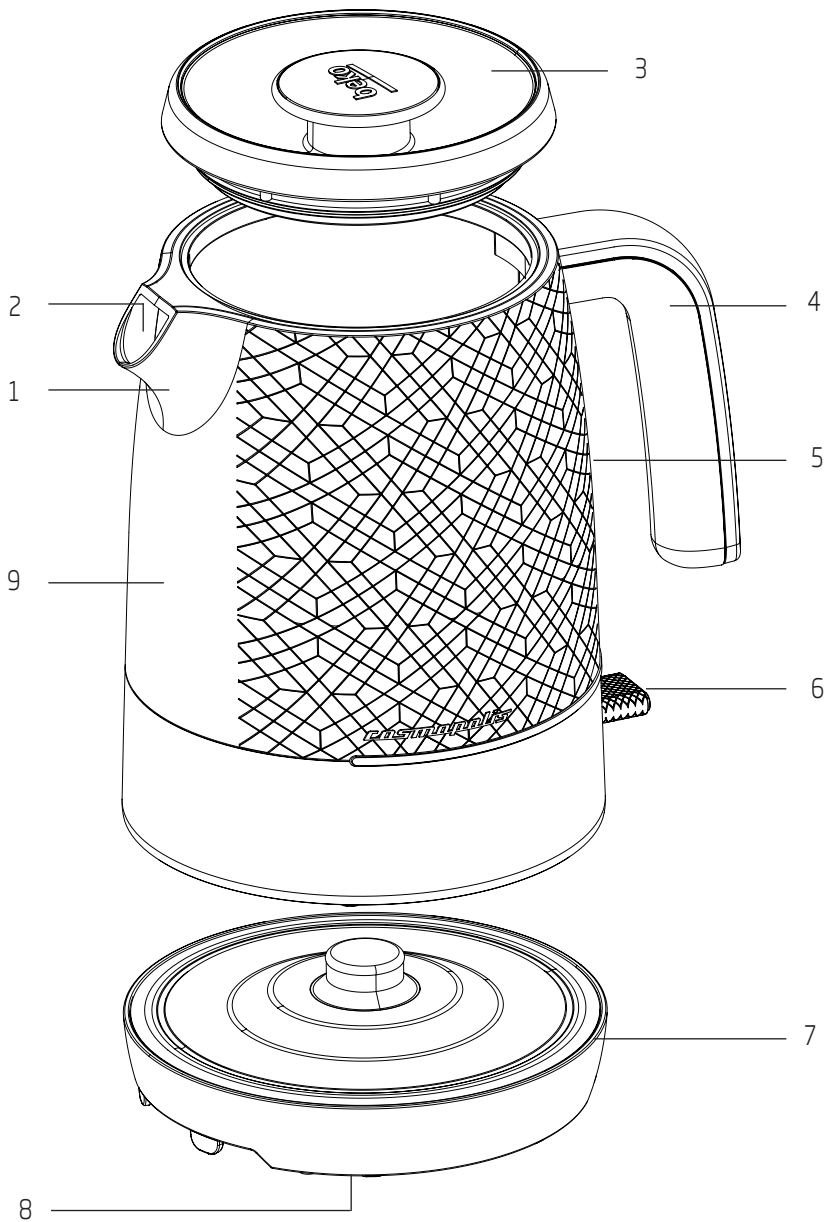

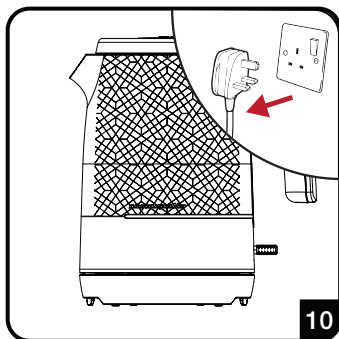
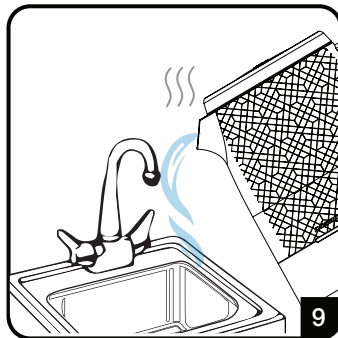
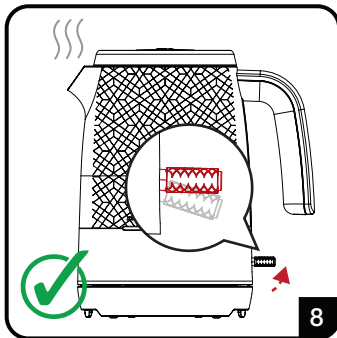
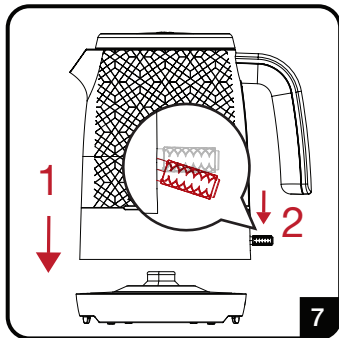
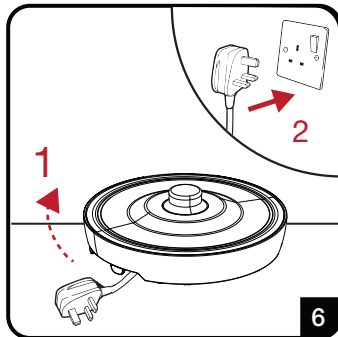
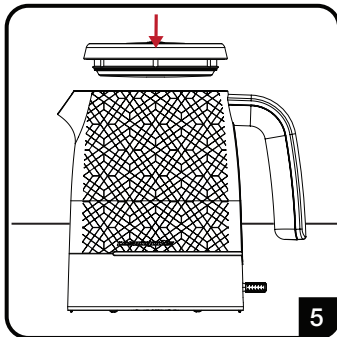
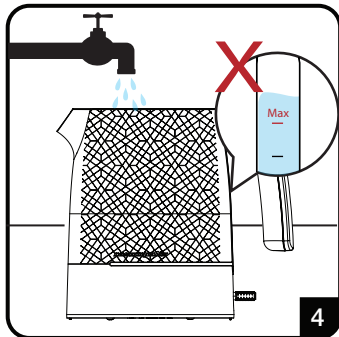
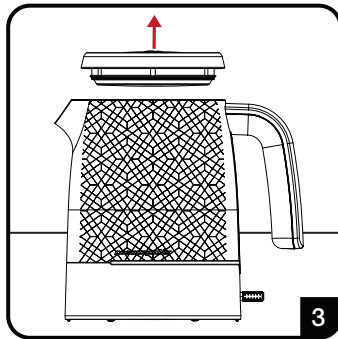
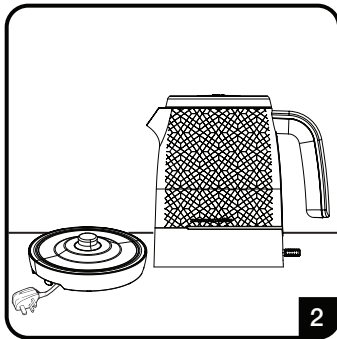
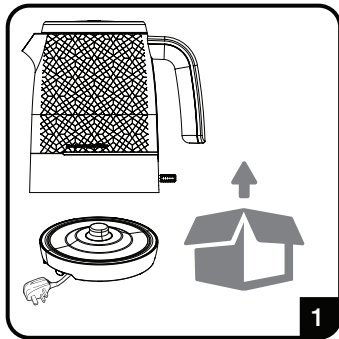

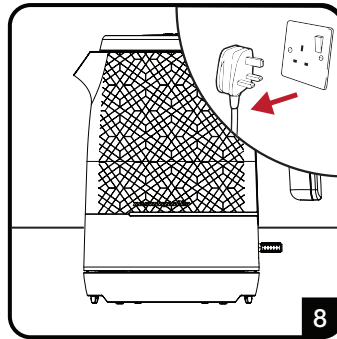
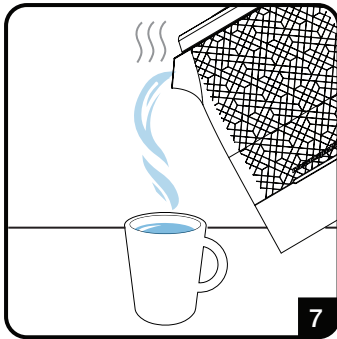
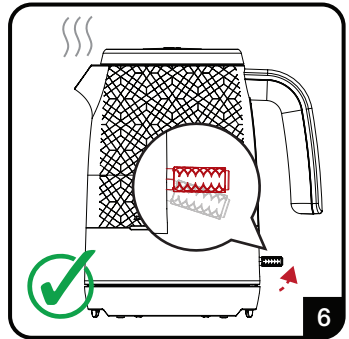
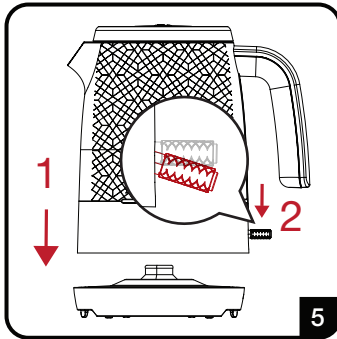
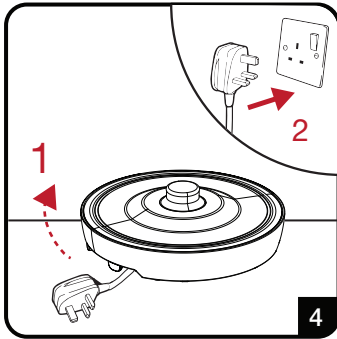
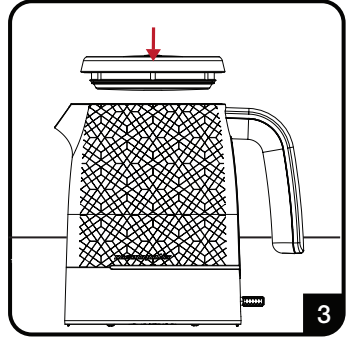
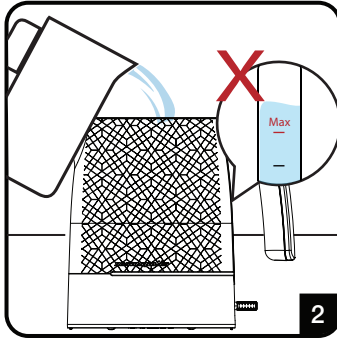
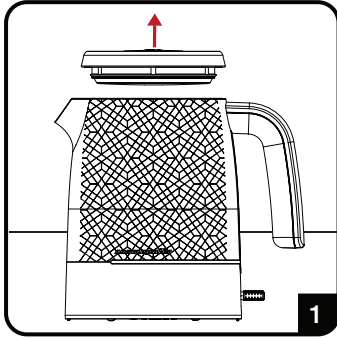

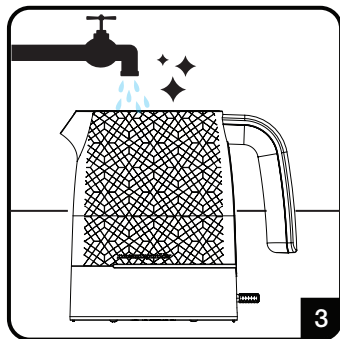
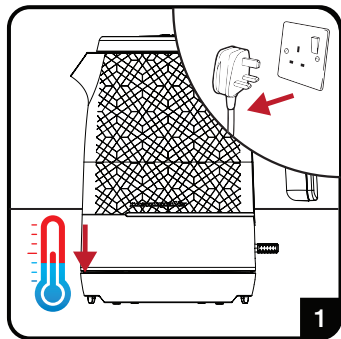

			
EN	FIRST USE	OPERATION	CLEANING AND CARE

Please read this user manual first!

Dear Customers,

Thank you for selecting a Beko product. We hope that you get the best results from your product which has been manufactured with high quality and state-of-the-art technology. Therefore, please read this entire user manual and all other accompanying documents carefully before using the product and keep it as a reference for future use. If you handover the product to someone else, give the user manual as well. Follow all warnings and information in the user manual.

1. Spout
2. Water filter (inside)
3. Lid
4. Handle
5. Water level indicator
6. On/Off switch
7. Base
8. Cable coil
9. Water tank

Meanings of the symbols

Following symbols are used in the various section of this manual:



WARNING: Warnings for dangerous situations concerning the safety of life and property.



WARNING: Warning for hot surfaces.



Important information and useful hints about usage.



Materials are intended to be in contact with food.



Do not immerse the appliance, power cord or power plug in water or in other liquids.

Technical data

Power supply: 220-240 V~, 50-60 Hz

Power: 2520 - 3000 W

Technical and design modifications reserved.



This product has been produced in environmentally-friendly, state-of-the-art facilities.

Complies with the WEEE Directive.



This product does not contain PCB's

1 Important instructions for safety and environment

This section contains safety instructions that will help protect from risk of personal injury or property damage.

Failure to follow these instructions invalidates the granted warranty.

1.1 General safety

- This appliance complies with the international safety standards.
- This appliance can be used by children aged from 8 years and above and persons with reduced physical, sensory or mental capabilities or lack of experience and knowledge if they have been given supervision or instruction concerning use of the appliance in a safe way and understand the hazards involved.
- This appliance is not intended for use by persons (including children) with reduced physical, sensory or mental capabilities, or lack of experience and knowledge, unless they have been given supervision or instruction concerning use of the appliance by a person responsible for their safety.
- Children should be supervised to ensure that they do not play with the appliance.
- Children shall not play with the appliance. Cleaning and user maintenance shall not be made by children unless they are older than 8 and supervised.
- Do not use the appliance outdoors or in the bathroom.
- Do not use it if the power cable or the appliance itself is damaged. Contact an authorised service.
- This appliance is intended to be used in household only. It is not designed for professional use in.
- Your mains power supply should comply with the information supplied on the rating plate of the appliance.
- For additional protection, this appliance should be connected to a household faulty current protection switch with no more than 30 mA.
- Use the appliance with a grounded outlet only.

1 Important instructions for safety and environment

- Do not use the appliance with an extension cord.
- Do not squeeze or bend the power cord and do not rub it on sharp edges in order to prevent any damage.
- Do not touch the appliance or its plug with wet or damp hands when the appliance is plugged in.
- Do not pull the power cable when unplugging the appliance.
- Never fill the appliance above the maximum level indicator, boiling water may splash out.
- Do not fill the kettle below the minimum level indicator.
- **WARNING:** Do not remove the lid while the water is boiling.
- Position the spout so that the hot steam is directed away from you.
- Hold the appliance by the handle only.
- Never operate the appliance without any water inside it.
- Do not fill the kettle when it is fitted on its base.
- Only operate the appliance with its original base.
- Always use the appliance on a stable and flat surface.
- Do not attempt to dismantle the appliance.
- Only use the original parts or parts recommended by the manufacturer.
- Cleaning operation shall appropriate to instruction given this user manual "CLEANING AND CARE" part.
- Unplug the appliance before cleaning. After cleaning, dry the appliance and all parts before connecting it to mains supply.
- Do not immerse the appliance, or power plug in water or any other liquids.
- Never use the appliance in or near to combustible or inflammable places and materials.
- If you keep the packaging materials, store them out of the reach of children.

1 Important instructions for safety and environment

- Children should be supervised to ensure that they do not play with the appliance.
- Only use the kettle for heating water. It is dangerous to misuse.
- Keep the appliance and its cord out of reach of children aged less than 8 years
- Do not touch the surfaces or heating plate of the kettle before it gets cool.
- This appliance is intended to be used in household and similar applications such as:
 - staff kitchen areas in shops, offices and other working environments;
 - farm houses;
 - by clients in hotels, motels and other residential type environments;
 - bed and breakfast type environments.
- Avoid spillage on the connector of the appliance.

1.2 Compliance with the WEEE Directive and Disposing of the Waste Product:

This product complies with EU WEEE Directive (2012/19/EU). This product bears a classification symbol for waste electrical and electronic equipment (WEEE).



This symbol indicates that this product shall not be disposed with other household wastes at the end of its service life. Used device must be returned to official collection point for recycling of electrical and electronic devices. To find these collection systems please contact to your local authorities or retailer where the product was purchased. Each household performs important role in recovering and recycling of old appliance. Appropriate disposal of used appliance helps prevent potential negative consequences for the environment and human health.

1.3 Compliance with RoHS Directive

The product you have purchased complies with EU RoHS Directive (2011/65/EU). It does not contain harmful and prohibited materials specified in the Directive.

1.4 Package information



Packaging materials of the product are manufactured from recyclable materials in accordance with our National Environment Regulations. Do not dispose of the packaging materials together with the domestic or other wastes. Take them to the packaging material collection points designated by the local authorities.

1 Important instructions for safety and environment

1.5 Plug Wiring

The moulded plug on this appliance incorporates a 13 A fuse. Should the fuse need to be replaced an ASTA approved BS1362 fuse of the same rating must be used. Do not forget to refit the fuse cover. In the event of losing the fuse cover, the plug must not be used until a replacement fuse cover has been fitted. Colour of the replacement fuse cover must be the same colour as that visible on the pin face of the plug. Fuse covers are available from any good electrical store.

1.5.1 Fiting a different plug

- As the colours of the wires in the mains lead of this appliance may not correspond with the coloured markings identifying the terminals on your plug, proceed as follows:
- Brown cable = L (Live)
- Blue cable = N (Neutral)
- Green/yellow cable must be connected to ground (E) \equiv line
- With the alternative plugs a 13 A fuse must be fitted either in the plug or adaptor or in the main fuse box. If in doubt contact a qualified electrician.

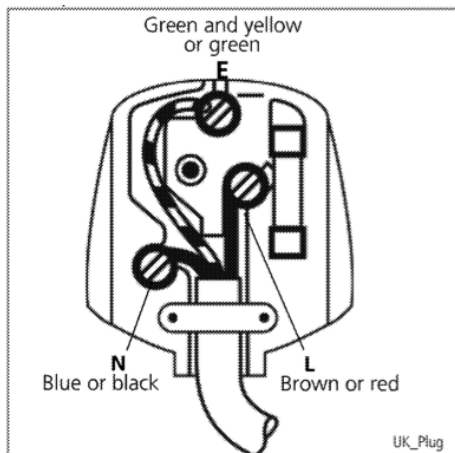

2 Operation



Do not place the water tank (9) on the base (7) while filling it with water.



Lid (3) should always be closed during the boiling process; otherwise the kettle will not switch off automatically.



WARNING: Do not open the lid (3) as hot water could splash out. Make sure that no water splashes onto the base (7).



Let the kettle cool down between each heating process.



WARNING: Never use petrol solvents, abrasive cleaners, metal objects or hard brushes to clean the appliance.



WARNING: Never put the appliance, base (7) or power cord in water or any other liquid.

3 Information

3.1 Descaling the kettle

Descaling extends the life of your kettle. Descaling period depends on the water hardness of your area.

1. Fill the heater with water up to the maximum level and boil.
2. After the heater is switched off, unplug the appliance.
3. Add 2 cups of white vinegar or 1 tablespoon of citric acid into the boiled water.
4. Keep the solution in the heater for a few hours.
5. Then pour it and rinse the inner part of the heater thoroughly.
6. Fill the heater with clean water and boil it.
7. Then empty the heater and rinse with water again.

3.2 Storage

- If you do not plan to use the appliance for a long period of time, please store it carefully.
- Make sure the appliance is unplugged, cooled down and completely dry.
- Store the appliance in a cool, dry place.
- Make sure the appliance is kept out of the reach of children.
- Wind up the power cord around the cable coil (8) on the bottom of the base (7).

3.3 Handling and transportation

- During handling and transportation, carry the appliance in its original packaging. The packaging of the appliance protects it against physical damages.
- Do not place heavy loads on the appliance or the packaging. The appliance may be damaged.
- Dropping the appliance will render it non-operational or cause permanent damage.

Product Guarantee

12 months breakdown and repair guarantee

Guarantor: **Beko plc, 1 Greenhill Crescent, Watford, Hertfordshire. WD18 8UF**

The guarantee does not in any way diminish your statutory or legal rights.

Your **appliance** has the benefit of our manufacturer's guarantee which covers the product for 12 months from the date of original purchase.

This gives you reassurance that if within that time, your **appliance** is proven to be defective because of either workmanship or materials, we will at our discretion either repair or replace your **appliance**.

The **appliance** must be correctly installed, located and operated in accordance with the instructions contained in the user manual. The guarantor disclaims any liability for accidental or consequential damage.

The Guarantee is subject to the following conditions:

- Documentary proof of the original purchase date is provided.
- The appliance has been installed and operated correctly and in accordance with our operating and maintenance instructions.
- The appliance is used only on the electricity supply on the rating plate.
- The appliance has only been used for normal domestic purposes.
- The appliance has not been altered, serviced, dismantled or otherwise interfered with by any person.
- The appliance is used in the United Kingdom or Republic of Ireland.
- Any parts removed during repair work or any product that has been replaced becomes our property.
- The guarantee is not transferrable if the product is resold.

The Guarantee does not cover:

- Transit, installation or delivery damage.
- Accidental damage.
- Misuse or abuse.
- Replacement of any consumable item or accessories. These include but are not limited to: plugs, cables, light bulbs, knobs, filters and flaps.
- Repairs or replacements required as a result of unauthorised repairs or inexperienced installation that fails to meet the requirements contained in the user guide or instruction book.
- Repairs to products used in commercial or non-residential household premises.

How to obtain after sales service, help or general advice

Please keep your purchase receipt or other proof of purchase in a safe place as you will need to show us this document if your product requires attention within the guarantee period.

Please also record your product details below, which will allow you to access our services more quickly and help us identify your product. The model number is printed on the front of the user guide and the serial and model number is shown on your products rating plate.

Model number	Serial number	Purchased from	Date of purchase

Please call our UK based Customer Service department if you need help or advice from us:

United Kingdom and Northern Ireland: **0333 207 9710**
Republic of Ireland: **01 862 3411**
You can also contact us through our website: **www.beko.co.uk**



Arçelik A.Ş. Karaağaç Cad. No: 2-6
Sütlüce, 34445, İstanbul, Türkiye

www.beko.co.uk