

## Cautions

### Symbol definition

- Warning** Pay special attention to the warning symbols. There may be serious risks to personal body safety or damages to the washing machine if not follow.
- Forbidden** Please stop doing the contents with this symbol, otherwise it will damage the appliance or injure your personal body.

Please insert the plug into the power socket with rated voltage 230V A/C.

Always unplug the appliance and turn off the water when the power is cut, moving or cleaning the washing machine, or it is not in use. Do not insert or pull off the plug with wet hand.



Do not make the electric cable bended, stretched, twisted, strapped or changed, pressed or nipped. If the supply cord is damaged, it must be replaced by the manufacturer, its service agent or similarly qualified persons in order to avoid a hazard. The pin of the plug must remain clean. Please clean it carefully with dry cloth if it is dirty.

Do not install the washing machine in bathroom or damp places. Do not wash the machine with water. Do not put wet clothes on the control panel film.

Do not use water hotter than 50°C



If the machine is situated on a carpeted floor, please adjust the feet in order to allow air to circulate freely.

Do not wash raincoat, bike cover, feather dress and waterproof laundries, which will caused the washing machine to have abnormal vibrations during spinning.

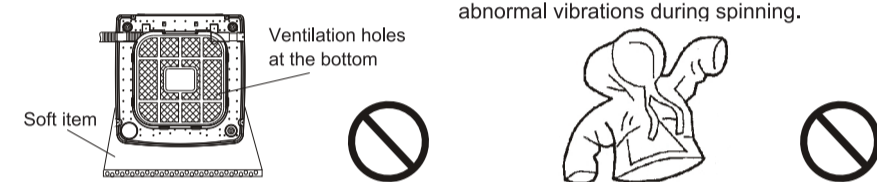

Do not share the same socket with other electric appliances. Do not use the damaged plug or loose socket.

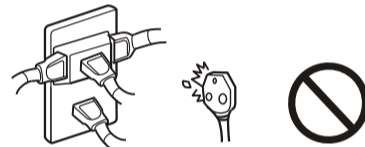

9

## Troubleshooting

Before contacting the technicians, please make the following checks:

Phenomena	Possible reason	Troubleshooting
Control panel has no display	Plug is not inserted tightly No electricity in the socket Power switch is not turned on Power supply is cut off	Insert the plug tightly Check the socket or change to another socket Press power switch Check power supply
Inlet hose leaks	Inlet hose connector(connecting with the tap)is not fixed tightly Inlet hose and washing machine connector is loose	Install the inlet hose again Tighten the connector of the machine
It does not drain	Drainpipe is not put down Drainpipe is bended or get blocked	Put down the drainpipe Straighten or clean the drainpipe
No inflow of water	No water supply Tap is not open Inlet hose gets blocked	Restart when water supply is resumed Open the tap Clean the filter according to before "clean inlet gate"
Spin stops and water inflow begins during spin program	Laundries is too much or too little or the Machine is not place stably	The machine is adjusting automatically
Press the program button to select SPIN, but it does not spin	Top lid was not closed when drain is finished Top lid was open when drain is started	Close the top lid Close the top lid
The spin is intermittent when spin starts	Balance the laundries to reach to the best spin effect	Normal
First time use, some water flows out from the drainpipe	The remaining water from factory's testing	Normal

Notes : If there is still a fault after the above checks, please pull out the plug and contact the seller right away. It is dangerous to repair this product by yourself.

12

## Cautions

Do not put hands into the working machine. It is dangerous even if the speed is very slow. Take special care of the children, and forbid them to climb on the washing machine.

It is dangerous to alter the specifications or attempt to modify this product in any way.



Do not overload the appliance or put any hotgoods(such as the kettle with hot water) on thewashing machine.

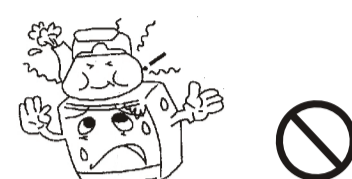

Garments which have been in contact with volatile petroleum products should not be machine washed.

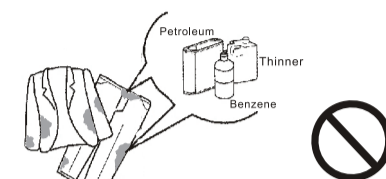

This appliance is not intended for use by persons(including children) with reduced physical, sensory or mental capabilities, or lack of experience and knowledge, unless they have been given supervision or instruction concerning use of the appliance by a person responsible for their safety. Children should be supervised to ensure that they do not play with the appliance.



Keep the appliance away from direct sunlight and heat sources like the heater.

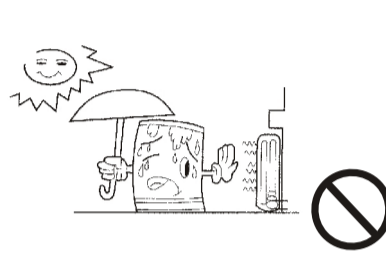

Any objects such as coins, safety pins, nails, screws, stones or any other hard, sharp material can cause extensive damage and must not be placed into the machine.

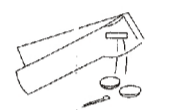

- Before washing, please ensure the tap is open and the inlet hose is installed properly.
- It is suggested to use low foam washing powder.

10

## Preparation before operation

### Preparation before washing

1. Connect the inlet hose and open the tap.
2. This appliance must be earthed. Confirm the socket is earthed reliably and insert the power plug. The earth terminal should not link to gas pipeline, tap pipeline etc.
3. Put down the drainpipe.

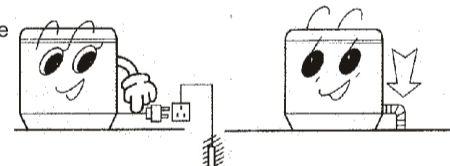

**Warning: the temperature of the water should be less than 50°C!**

### Before washing the laundries, please pay attention to the followings:

Make sure if there is special requirements for the laundries	Before washing, empty all pockets of small objects which may have been left inside(coins, keys, screws etc.).	Knot the long band, fasten the buttons and close the zippers.	Do not overload the machine. Load the laundry loosely alternating large items with small ones.	Sort the laundry according to the type of fabric, color-fastness and how dirty it is. Put thin laundries, woolens and such prone to wear and tear laundries into washing bag.
--	---	---	--	---

- A. Make sure the laundries are washable.
- B. It is essential to wash new colored items separately when washing for the first time. White items should not be washed with colored items.
- C. Please immerse the non-absorbable laundries by hand.
- D. Some stains such as fruit, wine, grass, rust etc. are difficult to remove and should be treated before washing with specific products, which can be found in most household shops. In some cases it may help to soak the stain before washing with a special pre-soak product or biological detergent.
- E. Overturn the nap fabric and long floss laundries before putting them into the machine.
- F. Do not put the laundries polluted by chemicals into the machine directly.
- G. Very small item(handkerchiefs, ribbons, socks etc) should be washed in a washing bag or a pillow case.

13

## Other functions

### 1. Abnormal display

Display	Explanation	Troubleshooting
E 0	The top lid is opened when preset is started	Close the top lid and clear the alarm
E 1	After draining for 5 minutes, it still does not reach to the minimum of water level	Please refer to Page 12 for troubleshooting
E 2	The top lid open when spinning	Close the top lid and clear the alarm
E 3	Spin is not balance	Open the top lid, place the laundries equally, then close it and clear the alarm
E 4	After inflow of water for 20 minute, it still does no treach to the water level set	Please refer to Page 12 for troubleshooting
E 5	The top lid is opened after setting child-lock	Close the top lid and dear the alarm
F 1	Water Level sensor is abnormal	Cut off the power supply to find a professional staff to process

### 2.Imbalance adjustment

During spinning, if the laundries are not placed equally in the tub, it would cause Violent vibration. This machine has imbalance adjustment function, and the vibration testing system will supervise the running. Once vibration is beyond certain level, the adjustment system will start automatically to adjust the imbalance.

### 3.Power supply is cut off automatically

- 1) If you did not start the program in 10 minutes after pressing the power supply button, the power supply will be cut off automatically.
- 2) After the washing is finished, alarm buzzes and the power supply will cut off automatically.

### 4.Child lock function

1)When child lock function is set, all the buttons will be locked including POWER. If the top lid is opened during the washing machine working, the washing will be stopped and give an alarm. But if you can close the top lid in 5 seconds, the alarm will stop and the washing machine will continue working. If cannot close the top lid in 5 seconds, the washing machine will begin draining if there is water in the inner tub, even closing the top lid is not valid. During the draining, alarm will buzz every 10 seconds, when the water in the inner tub is about 5cm higher, alarm will buzz every 10 minutes.When the draining is finished, the washing machine will be in the state of waiting, if close the top lid, the washing machine is unlocked and start working as previous setting.

2)Once child lock is set, if top lid is opened over 5 seconds during washing or rinse(there is water in the inner tub), washing machine will drain and alarm will buzz. If you unlock the function during draining, the washing machine will add water to water level set and continue working.

### 5.Water recycle function

When water recycle function is set, after the last rinse finished, the washing machine will not drain and spin.SPIN and WATER RECYCLE indicator light will be flashing and alarm will be given. The washing machine will stop working (if nobody operate, the alarm will be given every 10 minutes,in 1 hour, power supply will be cut off automatically). When press PLAY/PAUSE, WATER RECYCLE indicator light is on and the washing machine begin to drain and spin, the user can reuse the water.

11

## Load laundries

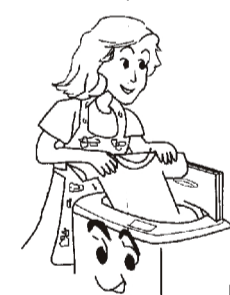

- The capacity of washing and spinning of the machine is refer to the largest weight of the standard laundries under dry condition. Washing quantity shall be lower than the rated capacity. The maximum capacity of this machine is 10.0kg.
- Different thickness, size and type of the laundries will influence the actual washing capacity.
- Do not select high water level when laundries are less than 1.0kg to avoid water splashing.

## Use of detergent

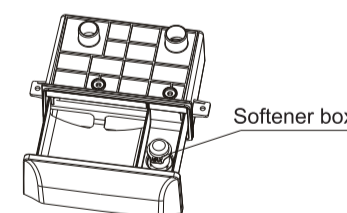

### How to use softener

- The machine automatically adds the softener to the inner tub during the last "rinse" process.

pls put the needed washing power in the detergent box and softener in softener box evenly

### How to use bleach

- Fill water to the selected level, dilute the bleach in the container, and pour it slowly into the washing tub.
- Do not use bleach for colored or figured laundries as they are prone to lose colors.
- Do not put bleach to laundries directly.
- Refer to the manual for the usage and quantity of the bleach.
- Please dissolve powder bleach before use.

### How to use the washing powder

- Dissolve in the machine directly (not suitable for preset program)
  1. Low water level.
  2. Add the washing powder, and run for 30 seconds to dissolve it completely.
  3. Put laundries in and select suitable water level.
- The instant dissolving of the washing powder
  1. Prepare warm water of 30°C in a container.
  2. Pour the powder while stirring to fully dissolve it.
- Washing powder with poor quality or not used for a long period may get blocked, please clean the detergent box in time.

Remarks: avoid splashing of water and waste of washing powder, water level should not be too high if laundries are too small.

14

# beko

## WTLJ110C1SM FULLY AUTOMATIC WASHING MACHINE Operation Manual

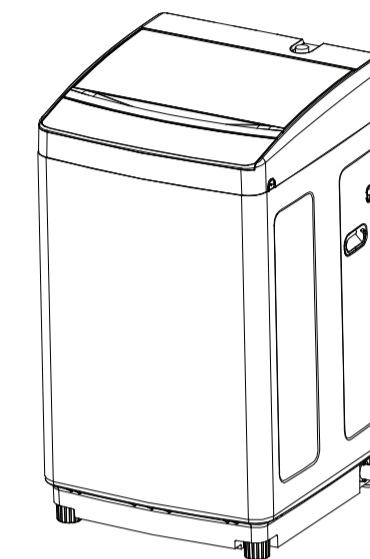

10.0kg

It is most important that this instruction book should be retained with the appliance for future reference. Should the appliance be sold or transferred to another owner, or should you move house and leave the appliance, always ensure the book is supplied with the appliance in order that the new owner can get to know the functioning of the appliance and the relevant warnings. These warnings have been provided in the interest of safety. You must read them carefully before installing or using the appliance.

## Specification

Model	WTLJ110C1SM
Rated capacity of wash and spin	10.0 kg
Rated voltage and frequency	220-240V~ 50Hz
Water level/water volume (about)	10/71L 9/65L 8/60L 7/55L 6/50L 5/45L 4/41L 3/37L 2/33L 1/29L
Inlet pressure	0.03MPa-0.85MPa
Rated input power	Wash: 525W spin: 330W
Weight	About 35kg
Product Dimensions	W564mm D578mm H968mm

12

13

14



## Parts name

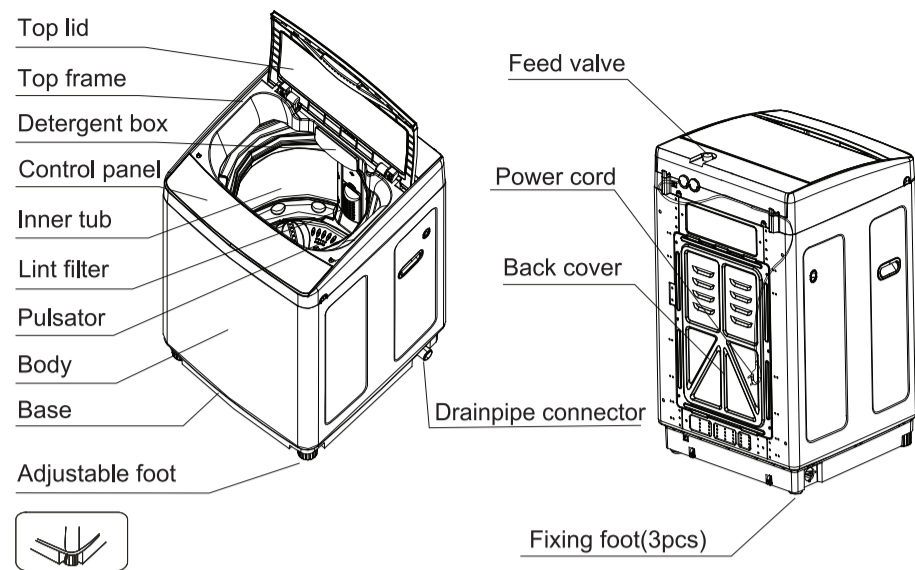

### Accessories

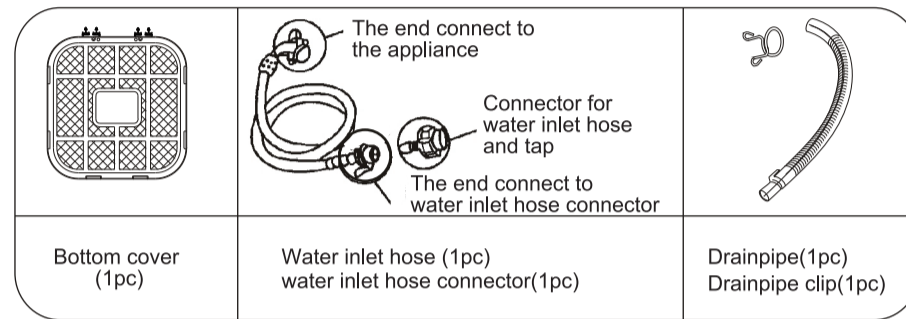

1

## Installation and adjustment

Please install and adjust the machine according to the requirements of the manual. Correct operation is very important for your safety.

### Unpacking

- Unpack the carton and take out the bottom cover.
- Open the top lid of washing machine and take out all of the accessories.
- Remove all wrappers, including the polystyrene base. You are advised to keep all the packaging for reuse in case the machine is to be transported again.

### Installing the bottom cover

- Let the back of washing machine incline forward, make the side of bottom cover with sticker description back to washing machine, insert to the bottom of washing machine along the direction of arrow.
- Remove two fixing clamp by scissors, insert to the accordingly holes black lines indicating ( gently pull fixing clamp should not be pulled out ), make the bottom cover fixed on the base.

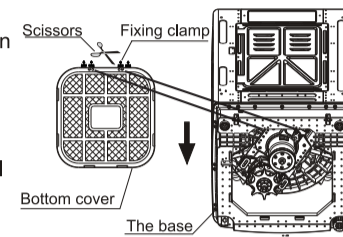

### Positioning

The distance between the washing machine and the wall should be more than 50mm, and the maximum allowed angle of the shank base of the machine is 1°. The slanting or rough ground may cause operating stopped or unstable, please adjust it with the following methods:

- Horizontal checking  
Use a tied thread with plumb to check if it is horizontal.
- Adjust the adjustable foot  
1) Lift up the adjustable foot gently, loose the adjustable nut and twist the adjustable foot.  
2) Fasten the nut after adjustment.

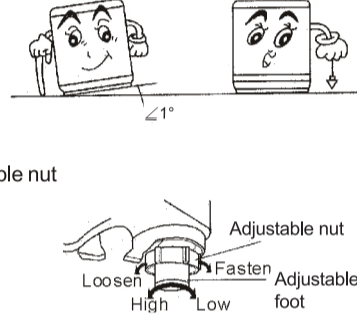

2

## How to use drainpipe

### Install drainpipe

Set drainpipe clip into the drainpipe between 2-3cm from the drainpipe end that without pothook. Then install the drainpipe into the right drainpipe connector and fix the drainpipe and drainpipe connector with the clip. After that, put up the drainpipe clip on the cabinet.

### How to change the direction of the drainpipe

1. Take off the drainpipe and drainpipe clip from drainpipe connector, put some soft mat on the floor. Positioned washing machine front side down and gently put down the washing machine front side on the mat. Demount the screws on the back cover with screwdriver and take out the back cover. Demount one screw that fixed the drainpipe connector (on right of the washing machine) and loosen the drainpipe connector.
2. Extrude the drainpipe with proper force and take out drainpipe hoop (on right of the washing machine), then loosen the inner drainpipe.

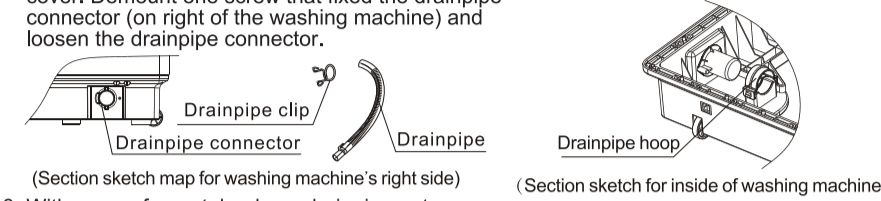

(Section sketch map for washing machine's right side)

(Section sketch for inside of washing machine)

3. With proper force, take down drainpipe gate stopper on left side of the washing machine. The drainpipe gate stopper is fixed on washing machine base with two clips.
4. Pull the inner drainpipe to another side. Fix inner drainpipe with drainpipe hoop, with one screw fix drainpipe connector. Install the drainpipe gate stopper to another side, make washing machine standing gently. Fix back cover with screw and install the drainpipe and drainpipe clip into the drainpipe connector.

(Section sketch map for washing machine's left side)

### Water drainage

- The drainpipe should drain smoothly
1. The height of the drainpipe should be less than 10cm, otherwise the drainage will not be smooth and need a long time to drain, the machine may stop during working.
  2. Do not step on or press the drainpipe.

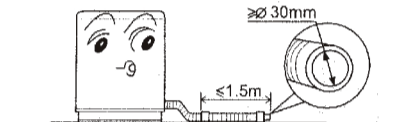
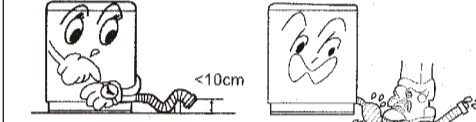

3. Cut the drainpipe if it is too long. Cut the front end of the drainpipe slantingly to make drainage smoothly.

If the additional drainpipe is too long, cut some at A or B point.

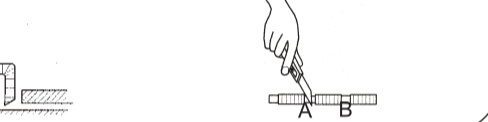

3

## Maintenance

### Maintenance methods

- After the end of the programme**
- The machine stops automatically, and music buzzer will remind you to take out the laundries or start again.
  - Once you have finished using the machine, you are advised to unplug it and turn off the water taps to avoid unexpected leak or fire.

**External cleaning**  
Clean the exterior cabinet of the appliance with soft cloth. Do not use cleanser, volatile chemical materials to clean the machine, which will damage plastic parts and the surface.



**Clean the lint filter**  
It is possible that the inlet filter net can be blocked by the dust, please clean it according to the following steps:

1. Close the tap and turn on the power switch.
2. Start the washing machine for 5 seconds (make the water in the inlet hose flows to the tub), and cut off the power supply.
3. Pull off the inlet hose, remove and clean the inlet valve and the inlet net, and install again.

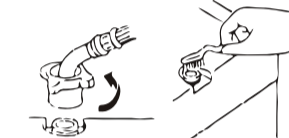

**Lint filter cleaning**  
Clean the lint filter after each use.

1. Press down on the clip to pull out the lint filter.
2. Open the lint filter, turn the filter out to remove impurities, and rinse the filter with water.
3. Restore the filter back to its original state. If there is lint on the back of the inner tub wall, clean it to avoid contamination of clothes during the next wash.

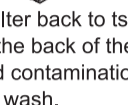
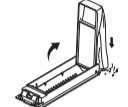

4. When replacing the lint filter, be careful not to compress the filter and make sure the lint filter is installed properly.

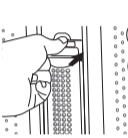

1. After using the machine, you are advised to turn off the water taps. (if necessary, pull out the inlet hose).
2. Do not keep water in tub for a long time. When washing is finished, drain it right away.
3. Once you have finished using the machine, you are advised to unplug it.
4. Put the electric cable and the drain hose in order.
5. Wipe the water on the surface and in the tub with soft cloth and keep the top lid opening for a while. It helps to prevent mold and smell forming inside the appliance. If the water in the inner tub has possibility to freeze, please do like below:
  1. In winter, if remaining water freeze can cause the washing machine trouble, please take off the water inlet hose and drain out the water in the hose and inner tub.
  2. If the water freeze, please don't operate the washing machine. Put 40°C hot water in the tub, the hot water should submerge the pulsator, after a few minutes, rotate the pulsator by hand gently, then you can operate the washing machine.

4

## Water inlet installation

### Tap selection

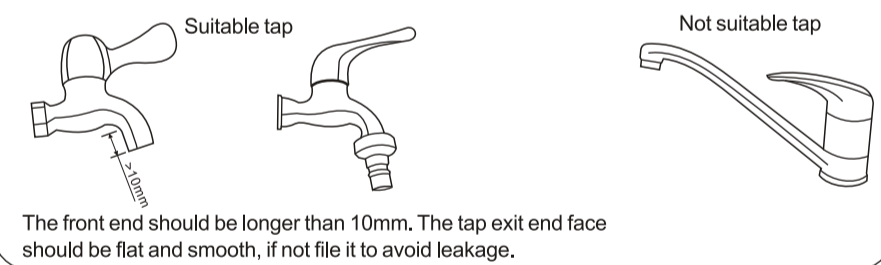

The front end should be longer than 10mm. The tap exit end face should be flat and smooth, if not file it to avoid leakage.

### Connect the inlet hose connector to the tap

1. Press down the slider and remove the inlet hose connector from the inlet hose, like below illustration 1.
2. Loosen the four bolts on the inlet hose connector till the tap can be accessed, then set the inlet hose connector in the tap, see illustration 2. (If the tap caliber is too larger and could not set the inlet hose end, unscrew the four bolts and take out the bushing, tap exit end must be flat, otherwise it will leak, see illustration 3).

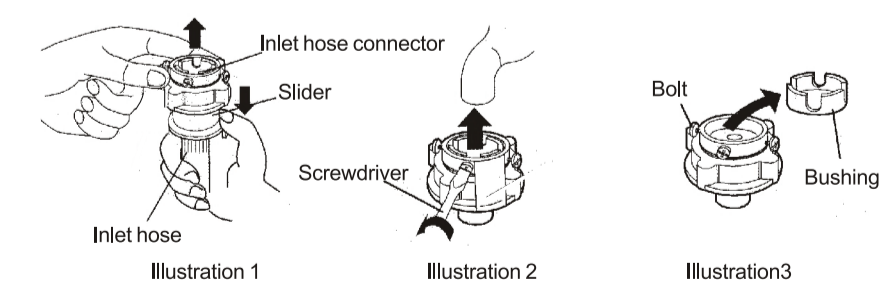

3. Fasten the four bolts in the inlet hose connector evenly, see illustration 4.
4. Twist the fastening nut as the illustration, see illustration 5.

Remark before twisting the nut, the threading is about 4mm above the upper surface of the nut, after twisting, the threading is less than 2mm above the upper surface of the nut, see illustration 6.

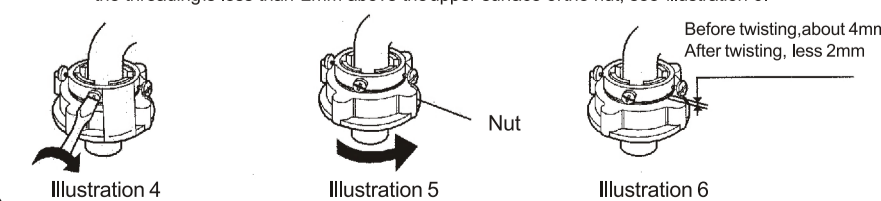

5

## Water inlet installation

### Connect the inlet hose to the washing machine

1. Do not take off the water absorption cushion. Please check if the cushion is dropped or damaged before each usage. If it is contact the seller immediately.
2. Put the inlet hose nut on the inlet valve connector.
3. Fasten the inlet hose nut and swing it gently to make sure if it is suitable.

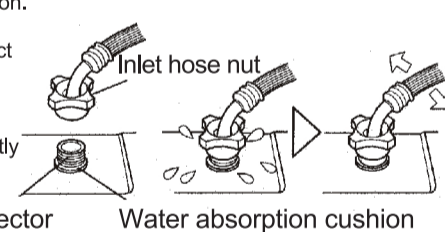

Cautions: When install the washing machine, please use a new hose. Do not reuse old hose

### Connect the inlet hose connector to the inlet hose

1. Put the slider down and insert the inlet hose into the inlet hose connector.
2. Insert the hose firmly and the click sound is heard.

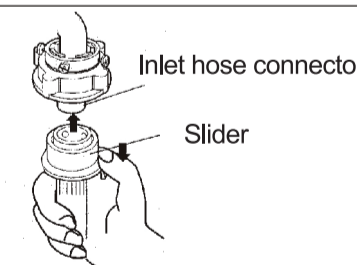

### Check the connection between inlet hose connector and the tap

1. Swing the inlet hose gently to confirm if it is fastened.
2. After installation, open the tap and check if it leaks.
3. Do not bend the inlet hose.
4. Before each usage, check the connection between inlet hose connector and the tap, and the installation of inlet hose. Make sure they are firmly fitted to prevent dropping from improper installation position.

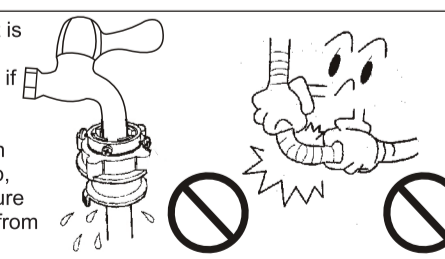

### Dismantle the inlet hose

1. Close the tap.
2. If you use the washing machine more than once a week there is no need to remove the inlet hose connector to avoid damaging the fixing screw.

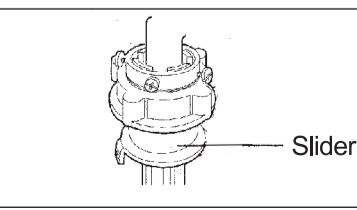

6

## Control panel instructions

### Control Panel

Mode and meaning of the indicator light

- On : Indicates the selected mode.
- Flashing : Indicates the program is running.

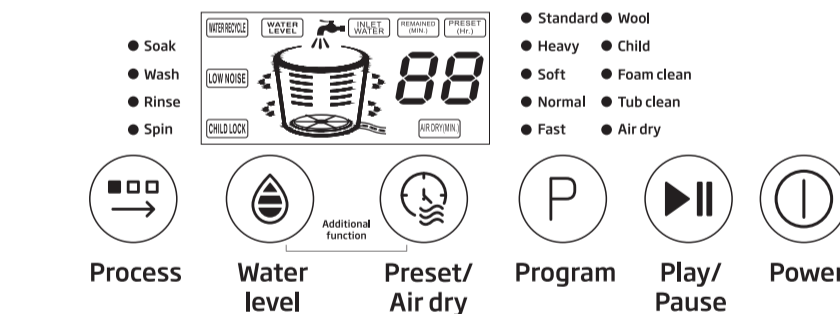

- Press PROCESS button to select one cycle at the start of the "Process Setting" from "WASH-RINSE-SPIN", "SPIN", "SOAK-WASH-RINSE-SPIN", "WASH", "WASH-RINSE", "RINSE-SPIN". The first process setting is "WASH-RINSE-SPIN".
- At the beginning of start, do not make any setting, press "process" button to set Spin only process or other processes.

- Start by pressing WATER LEVEL and at the same time press PRESET/AIR DRY, you can then select WATER RECYCLE, LOW NOISE or LOW NOISE-WATER RECYCLE. Only when both RINSE and SPIN are selected, WATER RECYCLE can be selected. Once LOW NOISE is selected, PROGRAM default setting is STANDARD and PROGRAM button is locked.
- During working, press WATER LEVEL and PRESET/AIR DRY to set CHILD LOCK. Press again to unlock this function.

- Before washing, the Digital Timer shows the set time, unit is Hour.
- If selecting AIR DRY, the Digital Timer displays air dry time, unit is Minutes.
- When washing, the Digital Timer shows the remaining time of washing, unit is Minutes.
- When trouble encountered, the Digital Timer shows trouble code.
- When it is ON and if with Fuzzy logic, the Digital Timer shows "-".

- To switch on the Washing Machine to working state or waiting state.

- After selecting the PROGRAM, PROCESS and WATER LEVEL, press this button to start. Press this button to pause during working, press again to continue.

- Select one program form, NORMAL, FAST, WOOL, CHILD, FOAM CLEAN, TUB CLEAN, AIR DRY, STANDARD, HEAVY, and SOFT.
- If no selection is selected, the process will start with the NORMAL program when the "PLAY/PAUSE" button is pressed.

- Press this button to select Preset Time from 2-24 hours.
- To cancel Preset Time, press POWER to set the washing machine to waiting state.
- To select AIR DRY, please press "PROGRAM" button to select AIR DRY, then press this button to set air dry time.

7

## Control panel instructions

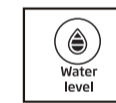

- If with Fuzzy Logic and WATER LEVEL is not selected, the Digital Timer shows "-". At this time, before pressing PLAY/PAUSE, if STANDARD or HEAVY is selected, it is with Fuzzy logic. When selecting NORMAL there is no Fuzzy Logic, the WATER LEVEL is at "10". When selecting FAST, there is no Fuzzy Logic, the WATER LEVEL is at "2".
- Press WATER LEVEL selector to select WATER LEVEL. At this time there is no Fuzzy Logic function and you can select appropriate water level. According to your laundry quantity, 1-2 is low water level, 3-6 is middle water level, 7-10 is high water level.
- During wash function (including rinse), if you need to add water, press WATER LEVEL button to add water, and release button to stop adding. PAUSE the Washing Machine and press WATER LEVEL button to select higher water level, then press PLAY/PAUSE button. The Washing Machine will add the water to setting water level automatically and continue working. If your resetting water level is lower than the present water level, the lower water level will be valid in next water inlet.
- Automatically adds water during SOAK, WASH and RINSE process. If the water level is lower than setting water level, the Washing Machine will pause and add water to setting water level automatically.

- Put through the power, press POWER button, the machine is in default "NORMAL" program. And when the program is set as "STANDARD" or "HEAVY", there will be FUZZY function:
1. If no water in the inner tub, the washing machine is in state of FUZZY, the process is "wash, rinse, spin". The program is "STANDARD", digital timer shows "-". At this time, if press "PLAY/PAUSE" button (or press "program" to select HEAVY), the washing machine can automatically set the water level according to the laundries quantity.
  2. If there is water in the inner tub, and the machine is in state of non FUZZY, the water level setting is "7". Process is "wash, rinse, spin", program is "STANDARD".

8

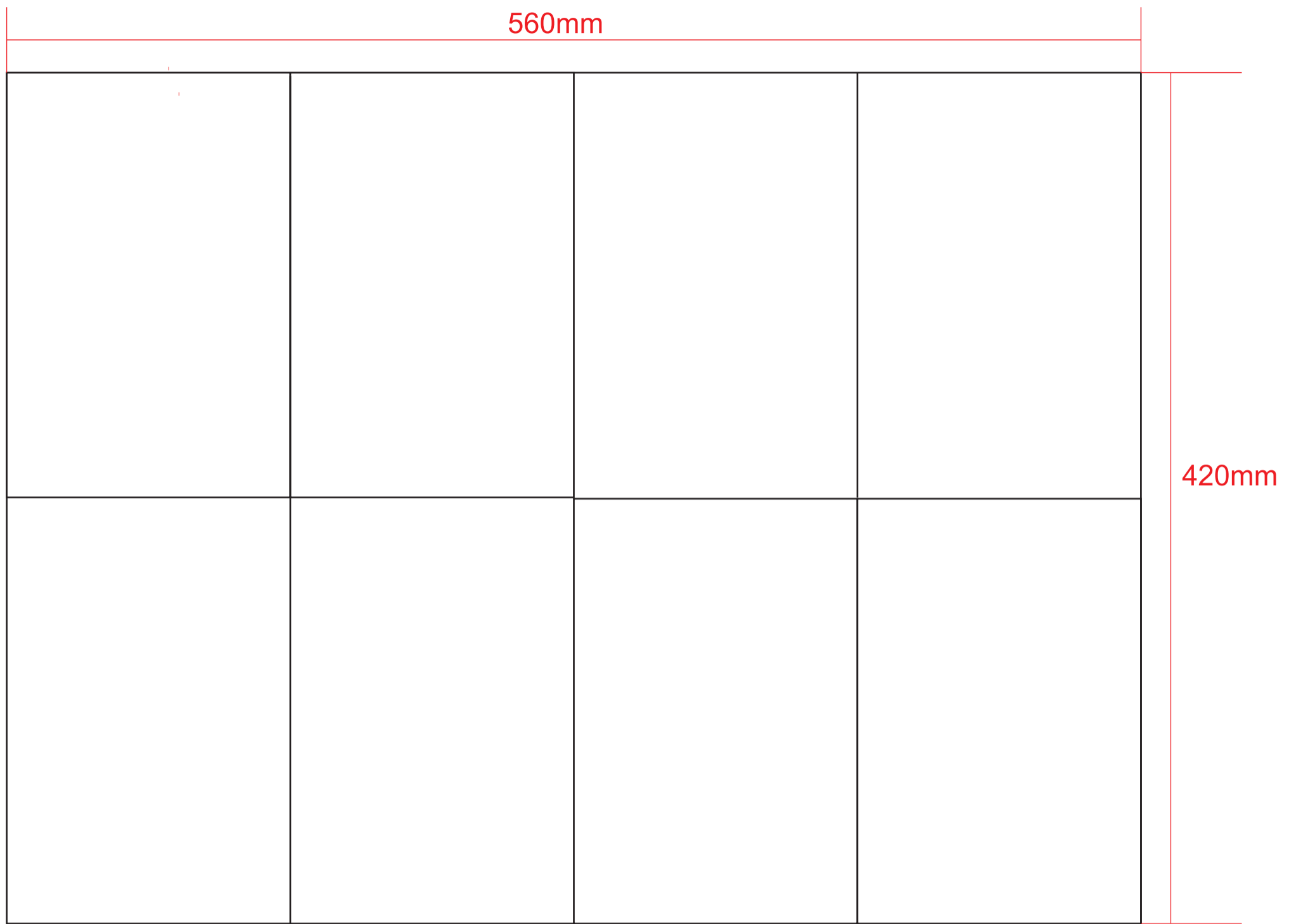

## 折叠方式

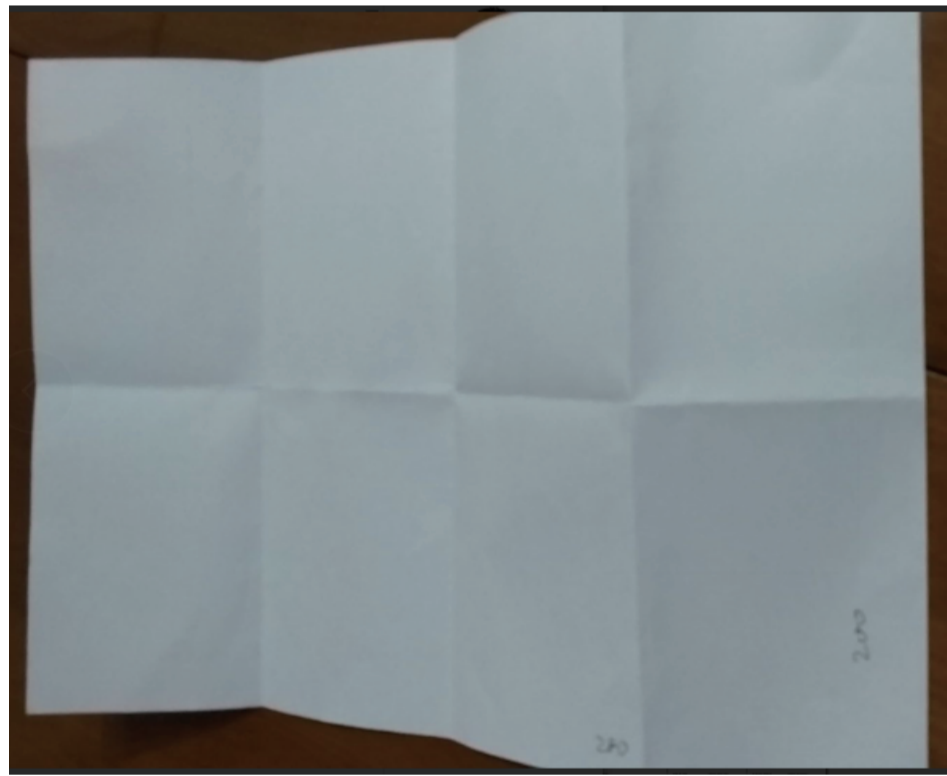

字体颜色：黑色  
双胶纸 70g