

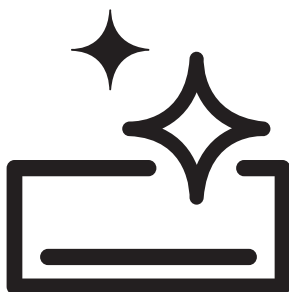

# Split type air conditioner

## User Manual



BLFOM 090 / BLFOM 091 BSVOM 090 / BSVOM 091  
BLFOM 120 / BLFOM 121 BSVOM 120 / BSVOM 121  
BLFOM 180 / BLFOM 181 BSVOM 180 / BSVOM 181

**EN**

08M-8502643200-1622-02

# Please read this user manual first!

Dear Customer,

Thank you for preferring a Beko product. We hope that you get the best results from your product which has been manufactured with high quality and state-of-the-art technology. Therefore, please read this entire user manual and all other accompanying documents carefully before using the product and keep it as a reference for future use. If you handover the product to someone else, give the user manual as well. Follow all warnings and information in the user manual.

## Meanings of the symbols

Following symbols are used in the various section of this manual:

	Important information or useful hints about usage.
---	--

	Warning for hazardous situations with regard to life and property.
---	--

	Warning to actions that must never perform.
---	---

	Warning for electric shock.
--	-----------------------------

	This symbol shows that information is available such as the operating manual or installation manual.
---	--

	Do not cover it.
---	------------------

	This symbol shows that the operation manual should be read carefully.
---	---

	This symbol shows that a service personnel should be handling this equipment with reference to the installation manual.
---	---

	This symbol shows that this appliance used a flammable refrigerant. If the refrigerant is leaked and exposed to an external ignition source, there is a risk of fire.
--	---



This product has been manufactured at modern facilities respectful to the environment without harming nature.

# Contents

<b>1 Safety instructions</b>	<b>4</b>
<b>2 Preparation before use</b>	<b>7</b>
2.1 Preset .....	7
2.2 Safeguarding the environment .....	7
<b>3 Safety precautions</b>	<b>9</b>
<b>4 Installation instructions</b>	<b>23</b>
4.1 Installation diagram .....	23
4.2 Select the installation location .....	24
4.2.1 Location for installing indoor unit .....	24
4.2.2 Location for installing outdoor unit .....	24
4.3 Indoor unit installation .....	25
4.4 Outdoor unit installation .....	35
4.5 Air purging .....	35
<b>5 Maintenance</b>	<b>38</b>
<b>6 Protection</b>	<b>40</b>
6.1 Operating condition .....	40
6.2 Noise pollution .....	41
6.3 Features of protector .....	41
6.4 Features of Heating mode .....	41
<b>7 Troubleshooting</b>	<b>42</b>
<b>8 Identification of parts</b>	<b>44</b>
<b>9 Display introduction</b>	<b>46</b>
<b>10 BLFOM spec sheet</b>	<b>47</b>
<b>11 BSVOM spec sheet</b>	<b>48</b>

## 1 Safety instructions

1. To guarantee the unit work normally, please read the manual carefully before installation, and try to install strictly according to this manual.
2. Do not let air enter the refrigeration system or discharge refrigerant when moving the air conditioner.
3. Properly ground the air conditioner into the earth.
4. Check the connecting cables and pipes carefully, make sure they are correct and firm before connecting the power of the air conditioner.
5. There must be an air-break switch.
6. After installing, the consumer must operate the air conditioner correctly according to this manual, keep a suitable storage for maintenance and moving of the air conditioner in the future.
7. Fuse of indoor unit: T3.15A 250VAC or T5A 250VAC. Please refer to the screen printing on the circuit board for the actual parameters, which must be consistent with the parameters on the screen printing.
8. The installation instructions for appliances that are intended to be permanently connected to fixed wiring, and have a leakage current that may exceed 10 mA, shall state that the installation of a residual current device (RCD) having a rated residual operating current not exceeding 30 mA is advisable.
9. Warning; Risk of electric shock can cause injury or death:  
Disconnect all remote electric power supplies before servicing.

## 1 Safety instructions

10. The maximum length of the connecting pipe between the indoor unit and outdoor unit should be less than 5 meters. It will affect the efficiency of the air conditioner if the distance longer than that length.
11. This appliance is not intended for use by persons (including children) with reduced physical, sensory or mental capabilities, or lack of experience and knowledge, unless they have been given supervision or instruction concerning use of the appliance by a person responsible for their safety. Children should be supervised to ensure that they do not play with the appliance. (be applicable for other countries except the European Countries)
12. This appliance can be used by children aged from 8 years and above and persons with reduced physical, sensory or mental capabilities or lack of experience and knowledge if they have been given supervision or instruction concerning use of the appliance in a safe way and understand the hazards involved. Children shall not play with the appliance. Cleaning and user maintenance shall not be made by children without supervision. (Be applicable for the European Countries).
13. The batteries in remote controller must be recycled or disposed of properly. Disposal of scrap batteries --- Please discard the batteries as sorted municipal waste at the accessible collection point.

## 1 Safety instructions

14. If the appliance is fixed wiring, the appliance must be fitted with means for disconnection from the supply mains having a contact separation in all poles that provide full disconnection under over voltage category III conditions, and these means must be incorporated in the fixed wiring in accordance with the wiring rules.  
If the supply cord is damaged, it must be replaced by the manufacturer, its service agent or similarly qualified persons in order to avoid a hazard.
15. If the supply cord is damaged, it must be replaced by the manufacturer, its service agent or similarly qualified persons in order to avoid a hazard.
16. The appliance shall be installed in accordance with national wiring regulations.
17. The air conditioner must be installed by professional or qualified persons.
18. The appliance shall not be installed in the laundry.
19. Regarding to installation, please refer to section "Installation instructions".
20. Regarding to maintenance, please refer to section "Maintenance".
21. For models using R32 refrigerant, piping connection should be conducted on outdoor side.

## 2 Preparation before use

### Note:



- When charging refrigerant into the system, make sure to charge in liquid state, if the refrigerant of the appliance is R32. Otherwise, chemical composition of refrigerant (R32) inside the system may change and thus affect performance of the air conditioner.
- According to the character of the tube is very high, so be sure to be careful when you install and repair the appliance.
- If the supply cord is damaged, it must be replaced by the manufacturer, its service agent or similarly qualified persons in order to avoid a hazard.
- Installation of this product must be done by experienced service technicians professional installers only in accordance with this manual.
- The temperature of refrigerant circuit will be high, please keep the interconnection cable away from the copper tube.

### 2.1 Preset

Before using the air conditioner, be sure to check and preset the following.

#### • Remote Control presetting

Each time after the remote control is replaced with new batteries or is energized, remote control auto presetting heat pump. If the air conditioner you purchased is a Cooling Only one, heat pump remote controller can also be used.

#### • Back-light function of Remote Control (optional)

Hold down any button on remote control to activate the back light. It automatically shuts off 10 seconds later.



**Note: Back-light is an optional function.**

#### • Auto Restart Presetting

The air conditioner has an Auto-Restart function.

### 2.2 Safeguarding the environment

This appliance is made of recyclable or re-usable material. Scrapping must be carried out in compliance with local waste disposal regulations. Before scrapping it, make sure to cut off the mains cord so that the appliance cannot be re-used.

## 2 Preparation before use

For more detailed information on handling and recycling this product, contact your local authorities who deal with the separate collection of rubbish or the shop where you bought the appliance.

### Scrapping of appliance

This appliance is marked according to the European directive 2012/19/EC, Waste Electrical and Electronic Equipment (WEEE).

This symbol indicates that this product shall not be disposed with other household wastes at the end of its service life. Used device must be returned to official collection point for recycling of electrical and electronic devices. To find these collection systems please contact to your local authorities or retailer where the product was purchased. Each household performs important role in recovering and recycling of old appliance. Appropriate disposal of used appliance helps prevent potential negative consequences for the environment and human health.





### 3 Safety precautions



Use correct power supply in accordance with the rating plate requirement. Otherwise, serious faults or hazard may occur or a fire may break out.



Keep the power supply circuit breaker or plug from dirt. Connect the power supply cord to it firmly and correctly, lest an electric shock or a fire break out due to insufficient contact.



Do not use the power supply circuit breaker or pull off the plug to turn it off during operation. This may cause a fire due to spark, etc.

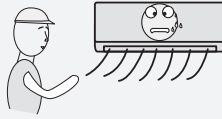

It is harmful to your health if the cool air reaches you for a long time. It is advisable to let the air flow be deflected to all the room.

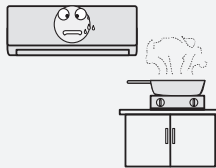

Prevent the air flow from reaching the gas burners and stove.

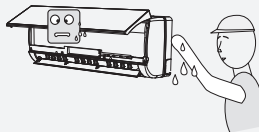

Do not touch the operation buttons when your hands are wet.

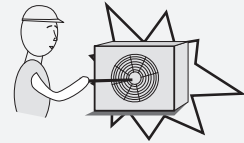

Never insert a stick or similar obstacle to the unit. Since the fan rotates at high speed, this may cause an injury.

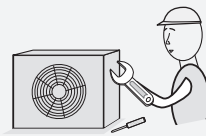

Do not repair the appliance by yourself. If this is done incorrectly, it may cause an electric shock, etc.

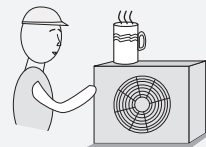

Do not put any objects on the outdoor unit.

### 3 Safety precautions



It is the user's responsibility to make the appliance be grounded according to local codes or ordinances by a licenced technician.



Turn off the appliance by remote control firstly before cutting off power supply if malfunction occurs.



Do not knit, pull or press the power supply cord, lest the power supply cord be broken. An electric shock or fire is probably caused by a broken power supply cord.

#### Precautions for using R32 refrigerant

For the multi system, the refrigerant refer to the multi outdoor unit. The basic installation work procedures are the same as the conventional refrigerant (R22 or R410A). However, pay attention to the following points:



#### Warning:

- 1. Transport of equipment containing flammable refrigerants**  
Compliance with the transport regulations
- 2. Marking of equipment using signs**  
Compliance with local regulations

## 3 Safety precautions

### 3. Disposal of equipment using flammable refrigerants

Compliance with national regulations

### 4. Storage of equipment/appliances

The storage of equipment should be in accordance with the manufacturer's instructions.

### 5. Storage of packed (unsold) equipment

- Storage package protection should be constructed such that mechanical damage to the equipment inside the package will not cause a leak of the refrigerant charge.
- The maximum number of pieces of equipment permitted to be stored together will be determined by local regulations.

### 6. Information on servicing

#### 6-1 Checks to the area

Prior to beginning work on systems containing flammable refrigerants, safety checks are necessary to ensure that the risk of ignition is minimised. For repair to the refrigerating system, the following precautions shall be complied with prior to conducting work on the system.

#### 6-2 Work procedure

Work shall be undertaken under a controlled procedure so as to minimise the risk of flammable gas or vapour being present while the work is being performed.

#### 6-3 General work area

- All maintenance staff and others working in the local area shall be instructed on the nature of work being carried out. Work in confined spaces shall be avoided.
- The area around the workspace shall be sectioned off. Ensure that the conditions within the area have been made safe by control of flammable material.



### 3 Safety precautions

#### 6-4 Checking for presence of refrigerant

- The area shall be checked with an appropriate refrigerant detector prior to and during work, to ensure the technician is aware of potentially flammable atmospheres.
- Ensure that the leak detection equipment being used is suitable for use with flammable refrigerants, i.e. non-sparking, adequately sealed or intrinsically safe.

#### 6-5 Presence of fire extinguisher

- If any hot work is to be conducted on the refrigeration equipment or any associated parts, appropriate fire extinguishing equipment shall be available to hand.
- Have a dry powder or CO2 fire extinguisher adjacent to the charging area.



#### 6-6 No ignition sources

- No person carrying out work in relation to a refrigeration system which involves exposing any pipe work that contains or has contained flammable refrigerant shall use any sources of ignition in such a manner that it may lead to the risk of fire or explosion.
- All possible ignition sources, including cigarette smoking, should be kept sufficiently far away from the site of installation, repairing, removing and disposal, during which flammable refrigerant can possibly be released to the surrounding space.
- Prior to work taking place, the area around the equipment is to be surveyed to make sure that there are no flammable hazards or ignition risks. "No Smoking" signs shall be displayed.

#### 6-7 Ventilated area

- Ensure that the area is in the open or that it is adequately ventilated before breaking into the system or conducting any hot work.

## 3 Safety precautions

- A degree of ventilation shall continue during the period that the work is carried out.
- The ventilation should safely disperse any released refrigerant and preferably expel it externally into the atmosphere.

### 6-8 Checks to the refrigeration equipment

- Where electrical components are being changed, they shall be fit for the purpose and to the correct specification.
- At all times the manufacturer's maintenance and service guidelines shall be followed. If in doubt consult the manufacturer's technical department for assistance.
- The following checks shall be applied to installations using flammable refrigerants:
  - The charge size is in accordance with the room size within which the refrigerant containing parts are installed;
  - The ventilation machinery and outlets are operating adequately and are not obstructed;
  - If an indirect refrigerating circuit is being used, the secondary circuit shall be checked for the presence of refrigerant;
  - Marking to the equipment continues to be visible and legible. Markings and signs that are illegible shall be corrected;
  - Refrigeration pipe or components are installed in a position where they are unlikely to be exposed to any substance which may corrode refrigerant containing components, unless the components are constructed of materials which are inherently resistant to being corroded or are suitably protected against being so corroded.



### 6-9 Checks to electrical devices

- Repair and maintenance to electrical components shall include initial safety checks and component inspection procedures.

### 3 Safety precautions

- If a fault exists that could compromise safety, then no electrical supply shall be connected to the circuit until it is satisfactorily dealt with.
- If the fault cannot be corrected immediately but it is necessary to continue operation, an adequate temporary solution shall be used.
- This shall be reported to the owner of the equipment so all parties are advised.
- Initial safety checks shall include:
  - That capacitors are discharged: this shall be done in a safe manner to avoid possibility of sparking;
  - That there no live electrical components and wiring are exposed while charging, recovering or purging the system;
  - That there is continuity of earth bonding.

#### 7. Repairs to sealed components



- During repairs to sealed components, all electrical supplies shall be disconnected from the equipment being worked upon prior to any removal of sealed covers, etc.
- If it is absolutely necessary to have an electrical supply to equipment during servicing, then a permanently operating form of leak detection shall be located at the most critical point to warn of a potentially hazardous situation.
- Particular attention shall be paid to the following to ensure that by working on electrical components, the casing is not altered in such a way that the level of protection is affected.
- This shall include damage to cables, excessive number of connections, terminals not made to original specification, damage to seals, incorrect fitting of glands, etc.
- Ensure that apparatus is mounted securely.
- Ensure that seals or sealing materials have not degraded such that they no longer serve the purpose of preventing the ingress of flammable atmospheres.

## 3 Safety precautions

- Replacement parts shall be in accordance with the manufacturer's specifications.



### Note:

The use of silicon sealant may inhibit the effectiveness of some types of leak detection equipment. Intrinsically safe components do not have to be isolated prior to working on them.



### 8. Repair to intrinsically safe components

- Do not apply any permanent inductive or capacitance loads to the circuit without ensuring that this will not exceed the permissible voltage and current permitted for the equipment in use.
- Intrinsically safe components are the only types that can be worked on while live in the presence of a flammable atmosphere. The test apparatus shall be at the correct rating.
- Replace components only with parts specified by the manufacturer.
- Other parts may result in the ignition of refrigerant in the atmosphere from a leak.

### 9. Cabling

- Check that cabling will not be subject to wear, corrosion, excessive pressure, vibration, sharp edges or any other adverse environmental effects.
- The check shall also take into account the effects of aging or continual vibration from sources such as compressors or fans.

### 10. Detection of flammable refrigerants

- Under no circumstances shall potential sources of ignition be used in the searching for or detection of refrigerant leaks.
- A halide torch (or any other detector using a naked flame) shall not be used.

## 3 Safety precautions



### 11. Leak detection methods

- The following leak detection methods are deemed acceptable for systems containing flammable refrigerants:
  - Electronic leak detectors shall be used to detect flammable refrigerants, but the sensitivity may not be adequate, or may need re-calibration. (Detection equipment shall be calibrated in a refrigerant-free area.)
  - Ensure that the detector is not a potential source of ignition and is suitable for the refrigerant used.
  - Leak detection equipment shall be set at a percentage of the LFL of the refrigerant and shall be calibrated to the refrigerant employed and the appropriate percentage of gas (25 % maximum) is confirmed.
  - Leak detection fluids are suitable for use with most refrigerants but the use of detergents containing chlorine shall be avoided as the chlorine may react with the refrigerant and corrode the copper pipe-work.
  - If a leak is suspected, all naked flames shall be removed/ extinguished.
  - If a leakage of refrigerant is found which requires brazing, all of the refrigerant shall be recovered from the system, or isolated (by means of shut off valves) in a part of the system remote from the leak.
  - Oxygen free nitrogen (OFN) shall then be purged through the system both before and during the brazing process.

### 12. Removal and evacuation

- When breaking into the refrigerant circuit to make repairs - or for any other purpose - conventional procedures shall be used.
- However, it is important that best practice is followed since flammability is a consideration.
- The following procedure shall be adhered to:



## 3 Safety precautions



- Remove refrigerant;
- Purge the circuit with inert gas;
- Evacuate;
- Purge again with inert gas;
- Open the circuit by cutting or brazing.
- The refrigerant charge shall be recovered into the correct recovery cylinders.
- The system shall be “flushed” with OFN to render the unit safe.
- This process may need to be repeated several times.
- Compressed air or oxygen shall not be used for this task.
- Flushing shall be achieved by breaking the vacuum in the system with OFN and continuing to fill until the working pressure is achieved, then venting to atmosphere, and finally pulling down to a vacuum.
- This process shall be repeated until no refrigerant is within the system. When the final OFN charge is used, the system shall be vented down to atmospheric pressure to enable work to take place.
- This operation is absolutely vital if brazing operations on the pipe-work are to take place.
- Ensure that the outlet for the vacuum pump is not close to any ignition sources and there is ventilation available.

### 13. Charging procedures

- In addition to conventional charging procedures, the following requirements shall be followed:
  - Ensure that contamination of different refrigerants does not occur when using charging equipment.
  - Hoses or lines shall be as short as possible to minimise the amount of refrigerant contained in them.
  - Cylinders shall be kept upright.
  - Ensure that the refrigeration system is earthed prior to charging the system with refrigerant.

### 3 Safety precautions

- Label the system when charging is complete (if not already).
- Extreme care shall be taken not to overfill the refrigeration system.
- Prior to recharging the system it shall be pressure tested with OFN.
- The system shall be leak tested on completion of charging but prior to commissioning.
- A follow up leak test shall be carried out prior to leaving the site.

#### 14. Decommissioning

- Before carrying out this procedure, it is essential that the technician is completely familiar with the equipment and all its detail.
  - It is recommended good practice that all refrigerants are recovered safely.
  - Prior to the task being carried out, an oil and refrigerant sample shall be taken in case analysis is required prior to re-use of reclaimed refrigerant. It is essential that electrical power is available before the task is commenced.
- a) Become familiar with the equipment and its operation.
  - b) Isolate system electrically.
  - c) Before attempting the procedure ensure that:
    - Mechanical handling equipment is available, if required, for handling refrigerant cylinders;
    - All personal protective equipment is available and being used correctly;
    - The recovery process is supervised at all times by a competent person;
    - Recovery equipment and cylinders conform to the appropriate standards.
  - d) Pump down refrigerant system, if possible.
  - e) If a vacuum is not possible, make a manifold so that refrigerant can be removed from various parts of the system.



### 3 Safety precautions

- f) Make sure that cylinder is situated on the scales before recovery takes place.
- g) Start the recovery machine and operate in accordance with manufacturer's instructions.
- h) Do not overfill cylinders. (No more than 80 % volume liquid charge).
- i) Do not exceed the maximum working pressure of the cylinder, even temporarily.
- j) When the cylinders have been filled correctly and the process completed, make sure that the cylinders and the equipment are removed from site promptly and all isolation valves on the equipment are closed off.
- k) Recovered refrigerant shall not be charged into another refrigeration system unless it has been cleaned and checked.

#### 15. Labelling



- Equipment shall be labelled stating that it has been de-commissioned and emptied of refrigerant.
- The label shall be dated and signed.
- Ensure that there are labels on the equipment stating the equipment contains flammable refrigerant.

#### 16. Recovery

- When removing refrigerant from a system, either for servicing or decommissioning, it is recommended good practice that all refrigerants are removed safely.
- When transferring refrigerant into cylinders, ensure that only appropriate refrigerant recovery cylinders are employed.
- Ensure that the correct number of cylinders for holding the total system charge is available.
- All cylinders to be used are designated for the recovered refrigerant and labelled for that refrigerant (i.e. special cylinders for the recovery of refrigerant).

### 3 Safety precautions



- Cylinders shall be complete with pressure relief valve and associated shutoff valves in good working order.
- Empty recovery cylinders are evacuated and, if possible, cooled before recovery occurs.
- The recovery equipment shall be in good working order with a set of instructions concerning the equipment that is at hand and shall be suitable for the recovery of flammable refrigerants.
- In addition, a set of calibrated weighing scales shall be available and in good working order.
- Hoses shall be complete with leak-free disconnect couplings and in good condition.
- Before using the recovery machine, check that it is in satisfactory working order, has been properly maintained and that any associated electrical components are sealed to prevent ignition in the event of a refrigerant release.
- Consult manufacturer if in doubt.
- The recovered refrigerant shall be returned to the refrigerant supplier in the correct recovery cylinder, and the relevant waste transfer note arranged.
- Do not mix refrigerants in recovery units and especially not in cylinders.
- If compressors or compressor oils are to be removed, ensure that they have been evacuated to an acceptable level to make certain that flammable refrigerant does not remain within the lubricant.
- The evacuation process shall be carried out prior to returning the compressor to the suppliers.
- Only electric heating to the compressor body shall be employed to accelerate this process.
- When oil is drained from a system, it shall be carried out safely.

### 3 Safety precautions



#### Warning:

- When moving or relocating the air conditioner, consult experienced service technicians for disconnection and reinstallation of the unit.
- Do not place any other electrical products or household belongings under indoor unit or outdoor unit. Condensation dripping from the unit might get them wet, and may cause damage or malfunction of your property.
- Do not use means to accelerate the defrosting process or to clean, other than those recommended by the manufacturer.
- The appliance shall be stored in a room without continuously operating ignition sources (for example, open flames, an operating gas appliance or an operating electric heater).
- Do not pierce or burn.
- Be aware that refrigerants may not contain an odor.
- To keep ventilation openings clear of obstruction.
- The appliance shall be stored in a well-ventilated area where the room size corresponds to the room area as specified for operation.
- The appliance shall be stored in a room without continuously operating open flames (for example an operating gas appliance) and ignition sources (for example an operating electric heater).

### 3 Safety precautions



#### Warning:

- Any person who is involved with working on or breaking into a refrigerant circuit should hold a current valid certificate from an industry-accredited assessment authority, which authorises their competence to handle refrigerants safely in accordance with an industry recognised assessment specification.
- Servicing shall only be performed as recommended by the equipment manufacturer.
- Maintenance and repair requiring the assistance of other skilled personnel shall be carried out under the supervision of the person competent in the use of flammable refrigerants.
- Do not use means to accelerate the defrosting process or to clean, other than those recommended by the manufacturer.
- Appliance shall be installed, operated and stored in a room with a floor area larger than 10 m<sup>2</sup>.
- The installation of pipe-work shall be kept to a room with a floor area larger than 10 m<sup>2</sup>.
- The pipe-work shall be complied with national gas regulations.
- The maximum refrigerant charge amount is 2.5 kg. The specific refrigerant charge is based on the nameplate of the outdoor unit.
- Mechanical connectors used indoors shall comply with ISO 14903. When mechanical connectors are reused indoors, sealing parts shall be renewed. When flared joints are reused indoors, the flare part shall be re-fabricated.
- The installation of pipe-work shall be kept to a minimum.
- Mechanical connections shall be accessible for maintenance purposes.

## 4 Installation instructions

### 4.1 Installation diagram

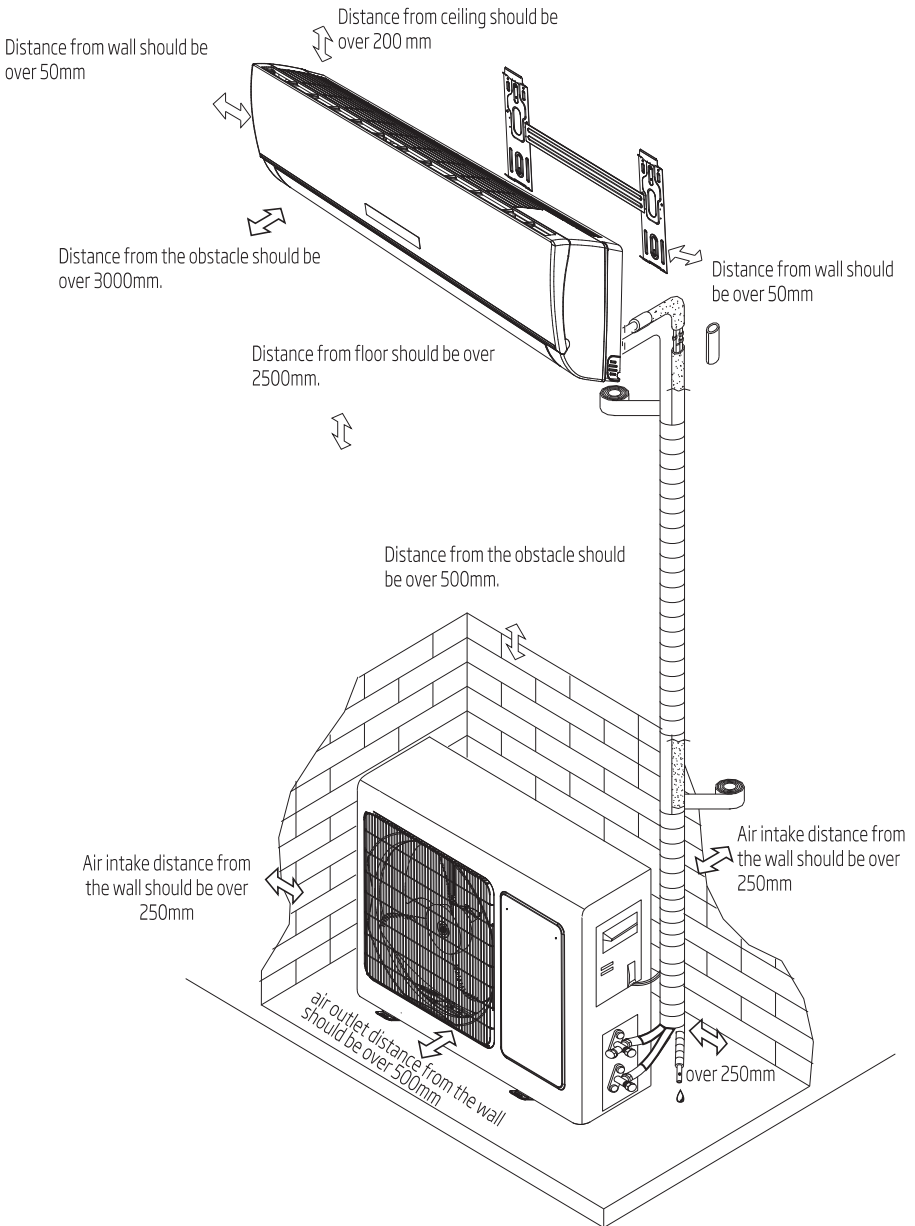

## 4 Installation instructions



### Note:

- Above figure is only a simple presentation of the unit, it may not match the external appearance of the unit you purchased.
- Installation must be performed in accordance with the national wiring standards by authorized personnel only.

## 4.2 Select the installation location

### 4.2.1 Location for installing indoor unit

- Where there is no obstacle near the air outlet and air can be easily blown to every corner.
- Where piping and wall hole can be easily arranged.
- Keep the required space from the unit to the ceiling and wall according to the installation diagram on previous page.
- Where the air filter can be easily removed.
- Keep the unit and remote controller 1m or more apart from television, radio etc.
- To prevent the effects of a fluorescent lamps, keep as far as possible.
- Do not put anything near the air inlet to obstruct it from air absorption.
- Where there is strong enough to bear the weight and is not tend to increase operation noise and vibration.

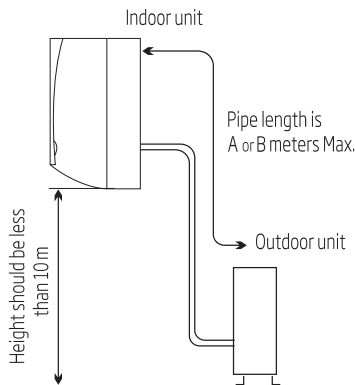

### 4.2.2 Location for installing outdoor unit

- Where it is convenient to install and well ventilated.
- Avoid installing it where flammable gas could leak.



## 4 Installation instructions

- Keep the required distance apart from the wall.
- The pipe length between indoor and outdoor unit should be not more than 5 meters in factory default status, but it can go up to maximum 15 meters with additional refrigerant charge.
- Keep the outdoor unit away from a place of greasy dirt, vulcanization gas exit.
- Avoid installing it at the roadside where there is a risk of muddy water.
- A fixed base where is not subject to increasing operation noise.
- Where there is not any blockage for air outlet.

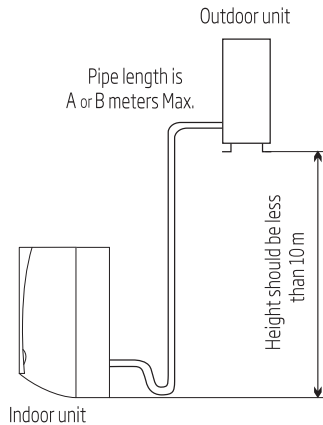

Model	Max.allowed pipe length without additional refrigerant(m)	Limit of pipe length (m)	Limit of elevation difference H (m)	Required amount of additional refrigerant (g/m)
5K~12K	5	20(A)	10	20
18K	5	25(B)	10	20

If the height or pipe length is out of the scope of the table, please consult the merchant.

### 4.3 Indoor unit installation

#### 1. Installing the mounting plate

- Decide an installing location for the mounting plate according to the indoor unit location and piping direction.
- Keep the mounting plate horizontally with a horizontal ruler or dropping line.
- Drill holes of 32 mm in depth on the wall for fixing the plate.

## 4 Installation instructions

- Insert the plastic plugs to the hole, fix the mounting plate with tapping screws.
- Inspect if the mounting plate is well fixed. Then drill a hole for piping.

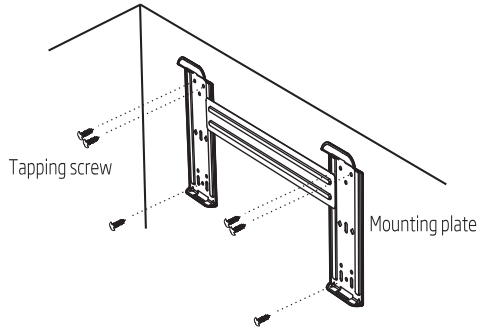

### Note:

The shape of your mounting plate may be different from the one above, but the installation method is similar.

As the above figure shown, the six holes matched with tapping screw on the mounting plate must be used to fix the mounting plate, the others are prepared.

### 2. Drill a hole for piping

- Decide the position of hole for piping according to the location of mounting plate.
- Drill a hole on the wall. The hole should tilt a little downward toward outside.
- Install a sleeve through the wall hole to keep the wall tidy and clean.

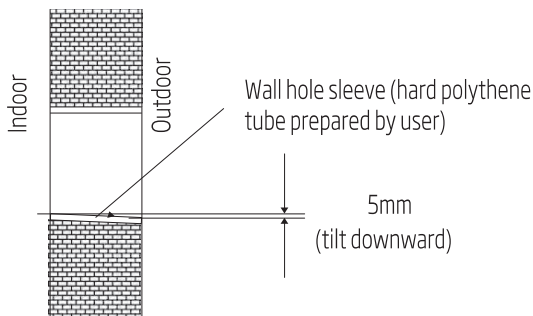

### 3. Indoor unit piping installation

- Put the piping (liquid and gas pipe) and cables through the wall hole from outside or put them through from inside after indoor piping and cables connection complete so as to connect to outdoor unit.

## 4 Installation instructions

- Decide whether saw the unloading piece off in accordance with the piping direction. (as shown below)

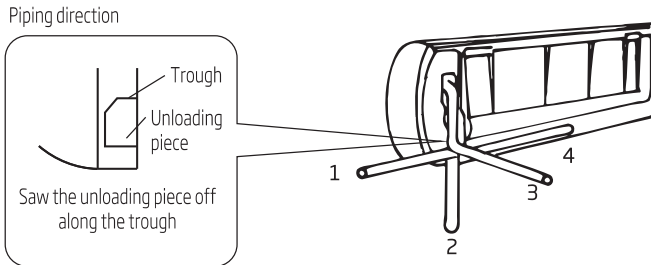

### Note:



When installing the pipe at the directions 1, 2 or 4, saw the corresponding unloading piece off the indoor unit base.

- After connecting piping as required, install the drain hose. Then connect the power cords. After connecting, wrap the piping, cords and drain hose together with thermal insulation materials.

### Note:



#### • Piping joints thermal insulation:

Wrap the piping joints with thermal insulation materials and then wrap with a vinyl tape.

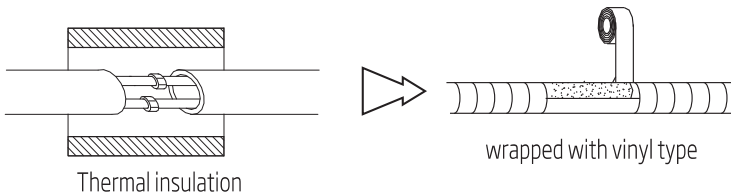

#### • Piping thermal insulation:

- Place the drain hose under the piping.
- Insulation material uses polythene foam over 6mm in thickness.



**Note:** Drain hose is prepared by user.

## 4 Installation instructions

- Drain pipe should point downward for easy drain flow.  
Do not arrange the drain pipe twisted, sticking out or wave around, do not immerse the end of it in water.  
If an extension drain hose is connected to the drain pipe, make sure to thermal insulated when passing along the indoor unit.
- When the piping is directed to the right, piping, power Cord and drain pipe should be thermal insulated and fixed onto the back of the unit with a piping fixer.

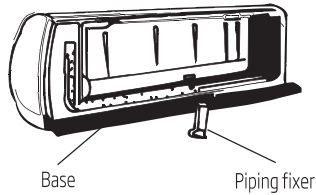
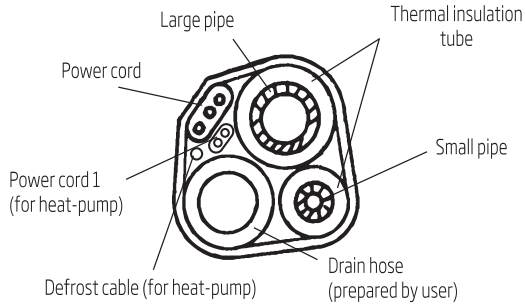

A. Insert the pipe fixer to the slot.

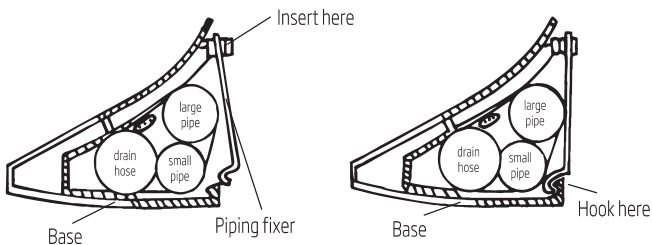

B. Press to hook the pipe fixer onto the base.

### Piping connection:

- a. Before unscrewing the big and the small sealing caps, press the small sealing cap with the finger until the exhaust noise stops, and then loosen the finger.

## 4 Installation instructions

- b. Connect indoor unit pipes with two wrenches. Pay special attention to the allowed torque as shown below to prevent the pipes, connectors and flare nuts from being deformed and damaged.
- c. Pre-tighten them with fingers at first, then use the wrenches.



**Note:** If you don't hear the exhaust noise, please contact with the merchant.

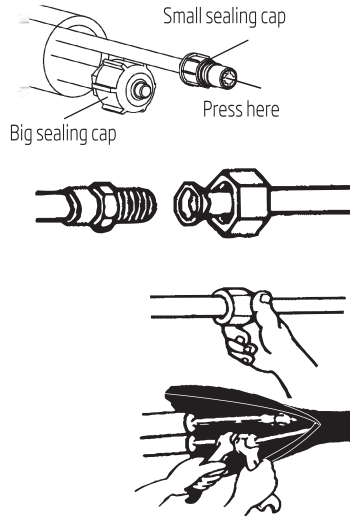

For Inverter appliance (BSVOM Series)

Model	Pipe size	Torque	Nut width	Min.thickness
5K~12K, 13K~18K, 21~24K	Liquid Side ( $\phi$ 6mm or 1/4 inch)	15~20N·m	1	0.5mm
18K#, 21K~36K	Liquid Side ( $\phi$ 9.53mm or 3/8 inch)	30~35N·m	2	0.6mm
5K~13K	Gas Side ( $\phi$ 9.53mm or 3/8 inch)	30~35	2	0.6mm
12K#, 13K~18K	Gas Side ( $\phi$ 12mm or 1/2 inch)	50~55N·m	2	0.6mm
18K#, 21K~36K	Gas Side ( $\phi$ 16mm or 5/8 inch)	60~65N·m	2	0.6mm
36K#	Gas Side ( $\phi$ 19mm or 3/4 inch)	70~75N·m	3	1.0mm



**Note:** The unit of 12K#, 18K#, and 36K# is bigger than the unit of 12K, 18K, and 36K.



**Note:** Piping connection should be conducted on outdoor side !

## 4 Installation instructions

For ON-OFF appliance (BLFOM Series)

Model	Pipe size	Torque	Nut width	Min.thickness
5~12K,13~18K,21~24K	Liquid Side ( $\phi$ 6mm or 1/4 inch)	15~20N·	1	0.5mm
18K*,22,24K*,28,30,36K	Liquid Side ( $\phi$ 9.53mm or 3/8 inch)	30~35N·m	2	0.6mm
5~10K,12K	Gas Side ( $\phi$ 9.53mm or 3/8 inch)	30~35	2	0.6mm
12K*,14,15,18K	Gas Side ( $\phi$ 12mm or 1/2 inch)	50~55N·m	2	0.6mm
18K*,22,24,28,30,36K	Gas Side ( $\phi$ 16mm or 5/8 inch)	60~65N·m	2	0.6mm
36K*	Gas Side ( $\phi$ 19mm or 3/4 inch)	70~75N·m	3	1.0mm



**Note:** The unit of 12K#,18K#,24K#,36K# is bigger than the unit of 12K,18K,24K,36K.

### 4. Connecting of the cable

- Indoor unit

Connect the power connecting cord to the indoor unit by connecting the wires to the terminals on the control board individually in accordance with the outdoor unit connection.



**Note:** For some models, it is necessary to remove the cabinet to connect to indoor unit terminal.

- Outdoor Unit

1. Remove the access door from the unit by loosening the screw. Connect the wires to the terminals on the control board individually as the following.
2. Secure the power connecting cord onto the control board with cable clamp.
3. Reinstall the access door to the original position with the screw.
4. Use a recognized circuit breaker for 24K model or above between the power source and the unit.  
A disconnecting device to adequately disconnected all supply lines must be fitted.

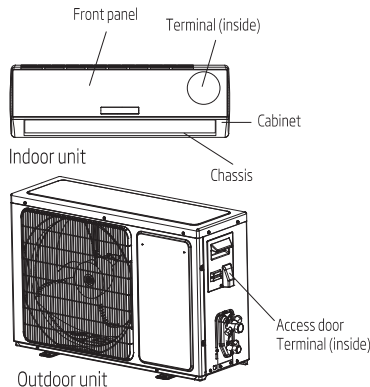

## 4 Installation instructions



**Note:** The figures in this manual are based on the external view of a standard model. Consequently, the shape may differ from that of the air conditioner you have selected.



### Warning:

1. Never fail to have an individual power circuit specifically for the air conditioner. As for the method of wiring, refer to the circuit diagram posted on the inside of the access door.
2. Confirm that the cable thickness is as specified in the power source specification.
3. Check the wires and make sure that they are all tightly fastened after cable connection.
4. Be sure to install an earth leakage circuit breaker in wet or moist area.

### Cable Specifications for Inverter appliance

Capacity (Btu/h)	Power cord		Power connecting cord	
	Type	Normal cross -sectional area	Type	Normal cross -sectional area
5K~13K	H07RN-F	0.75~1.5mm <sup>2</sup> X3	H05RN-F	0.75mm <sup>2</sup> X4
	H07RN-F	0.75~1.5mm <sup>2</sup> X3	H07RN-F	0.75~1.5mm <sup>2</sup> X5
5K*~13K*	H05VV-F	0.75~1.5mm <sup>2</sup> X3	H07RN-F	0.75~1.5mm <sup>2</sup> X4
	IS:694	0.75~1.5mm <sup>2</sup> X3	IS:9968	0.75~1.5mm <sup>2</sup> X4
14K~18K	H07RN-F	1.5mm <sup>2</sup> X3	H05RN-F	0.75mm <sup>2</sup> X4
	H07RN-F	1.5mm <sup>2</sup> X3	H07RN-F	1.5mm <sup>2</sup> X5
14K*~18K*	H05VV-F	1.5/2.5mm <sup>2</sup> X3	H07RN-F	1.5/2.5mm <sup>2</sup> X4
	IS:694	1.5/2.5mm <sup>2</sup> X3	IS:9968	1.5/2.5mm <sup>2</sup> X4
21K~36K	H07RN-F	2.5mm <sup>2</sup> X3	H05RN-F	0.75mm <sup>2</sup> X4
	H07RN-F	2.5mm <sup>2</sup> X3	H07RN-F	1.0mm <sup>2</sup> X4
	H07RN-F	2.5mm <sup>2</sup> X3	H07RN-F	2.5mm <sup>2</sup> X5
21K*~30K*	H05VV-F	2.5mm <sup>2</sup> X3	H07RN-F	2.5mm <sup>2</sup> X4
	IS:694	2.5mm <sup>2</sup> X3	IS:9968	2.5mm <sup>2</sup> X4
21K**~24K**	H05VV-F	1.5mm <sup>2</sup> X3	H07RN-F	1.5mm <sup>2</sup> X4

## 4 Installation instructions

1. K\* means power supply of this model comes from indoor unit.
2. K\*\* indicates indoor power supply unit model with power line plug.
3. For 14K\*~18K\* models under Tropical(T3) Climate condition, the normal cross-sectional area of Power cord and Power connecting cord is  $2.5\text{mm}^2 \times 4$ .

### Attention:

**The plug must be accessible even after the installation of the appliance in case there is a need to disconnect it. If not possible, connect appliance to a double-pole switching device with contact separation of at least 3 mm placed in an accessible position even after installation.**

### Cable Specifications for ON-OFF appliance

Capacity (Btu/h)	Power cord		Power connecting cord		Power connecting cord1		Main power supply
	Type	Normal cross-sectional area	Type	Normal cross-sectional area	Type	Normal cross-sectional area	
5K~13K	H05VV-F	0.75~1.5mm <sup>2</sup> X3	H07RN-F H05RN-F	1.5mm <sup>2</sup> X3 0.75~1.0mm <sup>2</sup> X3	H05RN-F	0.75mm <sup>2</sup> X2 (Heat-pump)	To indoor
14K~24K	H05VV-F	1.5~2.5mm <sup>2</sup> X3	H07RN-F	1.5~2.5mm <sup>2</sup> X3	H05RN-F	0.75mm <sup>2</sup> X2 (Heat-pump)	To indoor
18K~30K	H05VV-F	1.5~2.5mm <sup>2</sup> X3	H07RN-F	1.5~2.5mm <sup>2</sup> X4	H05RN-F	0.75mm <sup>2</sup> X2 (Heat-pump&Optional)	To indoor
18K~30K	H07RN-F	2.5mm <sup>2</sup> X3	H05RN-F H07RN-F	1.0mm <sup>2</sup> X3 1.0mm <sup>2</sup> X4 Cooling only	H05RN-F	0.75mm <sup>2</sup> X3 (Heat-pump)	To outdoor
24K~36K	H07RN-F	2.5~4.0mm <sup>2</sup> X3	H05RN-F H07RN-F	0.75mm <sup>2</sup> X4 1.0mm <sup>2</sup> X4	H05RN-F	0.75mm <sup>2</sup> X2 (Heat-pump&Optional)	To outdoor
24K~36K	H07RN-F	1.5mm <sup>2</sup> X5	H05RN-F	0.75mm <sup>2</sup> X4	H05RN-F	0.75mm <sup>2</sup> X2 (Heat-pump)	To outdoor

The cord may be different from the list above. It may be used as the next list. And it can be larger. 0-6A, use 0.75mm or 18AWG. 0-10A, use 1mm<sup>2</sup> or 16AWG. 0-16A, use 1.5mm<sup>2</sup> or 14AWG. 0-20A, use 2.5mm<sup>2</sup> or 14AWG. 0-25A, use 2.5mm<sup>2</sup> or 12AWG. 0-32A, use 4mm<sup>2</sup>



## 4 Installation instructions

### Wiring diagram



**Warning:** Before obtaining access to terminals, all supply circuits must be disconnected.



**Note:** All the wires may be different colors. The indicators '1L 2L 3L' may be '4 5 6' or others. And the terminal may be different from the material object.

- For ON-OFF appliance (BLFOM Series)

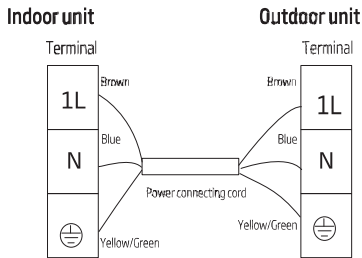

For above models, the power supply are connected from indoor unit.

For these models, the ground wire may be connected to the electric box directly.

- For inverter appliance (BSVOM Series)

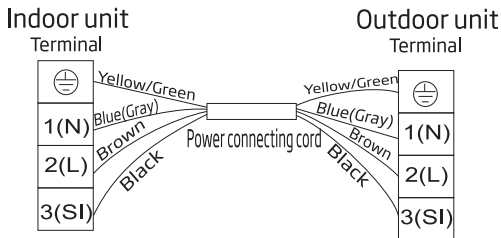

For above models, the power supply are connected from indoor unit.

For these models, the ground wire may be connected to the electric box directly.

## 4 Installation instructions

For these models, the power supply are connected from outdoor unit, with a circuit breaker.

All the wires may be different colors.

- Defrost cable (for heat-pump air conditioner only ,and it`s an optional part)

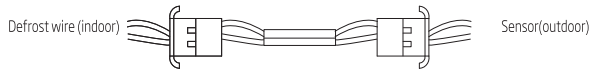

After connection, the defrost wire should be well wrapped with a wrapping tape and the connector should be put inside the unit.

- Overheat protection or high pressure protection cable (it`s an optional part)

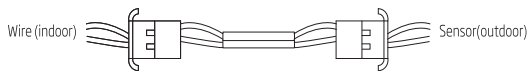

After connection, the wire should be well wrapped with a wrapping tape and the connector should be put inside the unit.

- Ionizer ( The ionizer is an optional part)



After connection, the ionizer will work automatically.

## 4 Installation instructions

### 4.4 Outdoor unit installation

1. Install drain port and drain hose (for heat-pump model only)

The condensate drains from the outdoor unit when the unit operates in heating mode. In order not to disturb your neighbor and protect the environment, install a drain port and a drain hose to direct the condensate water. Just install the drain port and rubber washer to the chassis of the outdoor unit, then connect a drain hose to the port as the following figure shown.

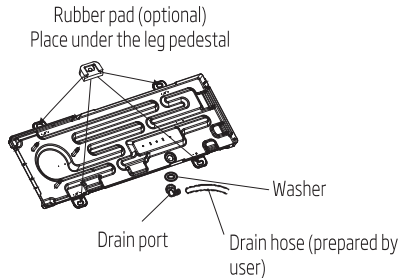

2. Install and fix outdoor unit

Fix with bolts and nuts tightly on a flat and strong floor.

If installed on the wall or roof, make sure to fix the supporter well to prevent it from shaking due to serious vibration or strong wind.

3. Outdoor unit piping connection

- Remove the valve caps from the 2-way and 3-way valve.
- Connect the pipes to the 2-way and 3-way valves separately according to the required torque.

4. Outdoor unit cable connection (see previous page)

### 4.5 Air purging

The air which contains moisture remaining in the refrigeration cycle may cause a malfunction on the compressor. After connecting the indoor and outdoor units, release air and moisture from the refrigerant cycle using a vacuum pump, as shown below.



**Note:** To protect the environment, be sure not to discharge the refrigerant to the air directly.

## 4 Installation instructions

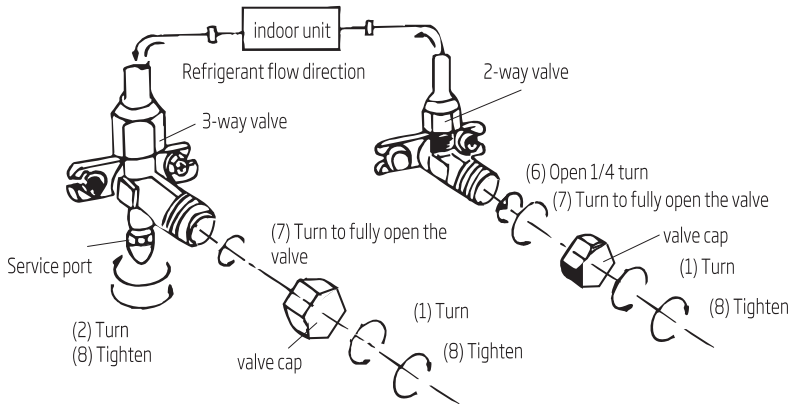
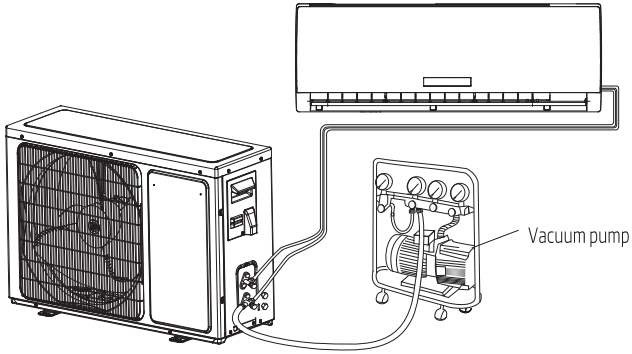

3-way valve diagram

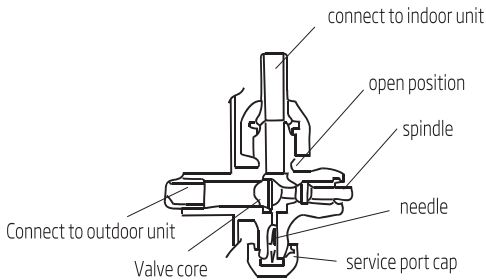

## 4 Installation instructions

How to purge air tubes:

1. Unscrew and remove caps from 2 and 3-way valves.
2. Unscrew and remove cap from service valve.
3. Connect vacuum pump flexible hose to the service valve.
4. Start vacuum pump for 10-15 minutes until reaching a vacuum of 10 mm Hg absolutes.
5. With vacuum pump still running close the low pressure knob on vacuum pump manifold. Then stop vacuum pump.
6. Open 2-way valve 1/4 turn then close it after 10 seconds. Check tightness of all joints using liquid soap or an electronic leak detector.
7. Turn 2 and 3-way valves stem to fully open the valves. Disconnect vacuum pump flexible hose.
8. Replace and tighten all valve caps.

## 5 Maintenance

### • Front panel maintenance

#### 1. Cut off the power supply

Turn off the appliance first before disconnecting from power supply.

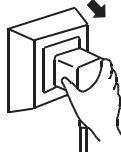

#### 2. Grasp position "a" and pull outward to remove the front panel.

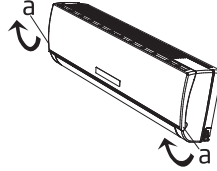

#### 3. Wipe with a soft and dry cloth.

Use soft moisture cloth to clean if the front panel is very dirty;



#### 4. Never use volatile substance such as gasoline or polishing powder to clean the appliance.



#### 5. Never sprinkle water onto the indoor unit

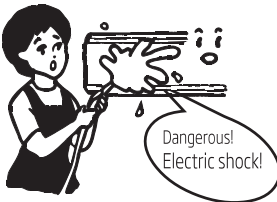

#### 6. Reinstall and shut the front panel.

Reinstall and shut the front panel by pressing position "b" downward.

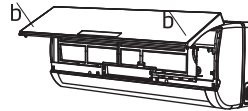

## 5 Maintenance

### • Air filter maintenance

1. Stop the appliance, cut off the power supply and remove the air filter.

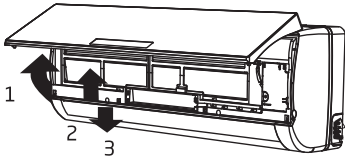

1. Open the front panel.
2. Press the handle of the filter gently from the front.
3. Grasp the handle and slide out the filter.

2. Clean and reinstall the air filter.

If the dirt is conspicuous, wash it with a solution of detergent in lukewarm water. After cleaning, dry well in shade.



3. Close the front panel again.



**Note:** Clean the air filter every two weeks if the air conditioner operates in an extremely dusty environment.

**It is necessary to clean the air filter after using it for about 100 hours.**

## 6 Protection

### 6.1 Operating condition

#### Operating temperature for Inverter appliance

Temperature		Cooling	Heating operation	Drying
Indoor temperature	max	32°C	27°C	32°C
	min	21°C	7°C	18°C
Outdoor temperature	max	*note	24°C	43°C
	min	*note	-15°C	21°C



**NOTE:**

\*Optimum performance will be achieved within these operating temperature. If air conditioner is used outside of the above conditions, the protective device may trip and stop the appliance.

\*Normally, the outdoor max temperature is 43°C, but some models will be achieved 46°C, 48°C, or 50°C. For Tropical (T3) Climate condition models, the outdoor max temperature is 55°C.

\*For some models, can keep cooling at -15°C outdoor ambient via unique design. Normally, optimum cooling performance will be achieved above 21°C. Please consult the merchant to get more information.

\*For some models, can keep heating at -15°C outdoor ambient, some models heat at -20°C outdoor ambient, even heat at lower outdoor ambient. The temperature of some products is allowed beyond the range. In specific situation, please consult the merchant. When relative humidity is above 80%, if the air conditioner runs in COOLING or DRY mode with door or window opened for a long time, dew may drip down from the outlet.

#### Operating temperature for ON-OFF appliance

The protective device may trip and stop the appliance in the cases listed below

<b>HEATING</b>	Outdoor air temperature is over 24°C
	Outdoor air temperature is below -7°C
	Room temperature is over 27°C

<b>COOLING</b>	Outdoor air temperature is over 43°C
	Room temperature is below 21°C
<b>DRY</b>	Room temperature is below 18°C



**NOTE:**

\*Normally, the outdoor max temperature is 43°C, but some models will be achieved 46°C, 48°C, or 50°C. For Tropical (T3) Climate condition models, the outdoor max temperature is 55°C. The temperature of some products is allowed beyond the range. In specific situation, please consult the merchant. If the air conditioner runs in COOLING or DRY mode with door or window opened for a long time when relative humidity is above 80%, dew may drip down from the outlet.



## 6 Protection

### 6.2 Noise pollution

- Install the air conditioner at a place that can bear its weight in order to operate more quietly.
- Install the outdoor unit at a place where the air discharged and the operation noise would not annoy your neighbors.
- Do not place any obstacles in front of the air outlet of the outdoor unit lest it increases the noise level.

### 6.3 Features of protector

#### 1. The protective device will work at following cases.

- Restarting the unit at once after operation stops or changing mode during operation, you need to wait for 3 minutes.
- Connect to power supply and turn on the unit at once, it may start 20 seconds later.

#### 2. If all operation has stopped, press **ON/OFF** button again to restart, Timer should be set again if it has been canceled.

### 6.4 Features of Heating mode

#### Preheat

At the beginning of the Heating operation, the airflow from the indoor unit is discharged 2-5 minutes later.

#### Defrost

In **Heating** operation the appliance will defrost (de-ice) automatically to raise efficiency.

This procedure usually lasts 2-10 minutes. During defrosting, fans stop operation.

After defrosting completes, it returns to **Heating** mode automatically.





**Note:** Heating is not available for cooling only air conditioner models.

## 7 Troubleshooting

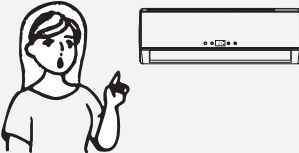
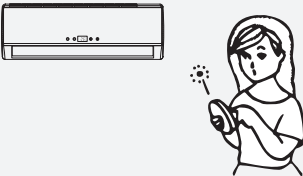
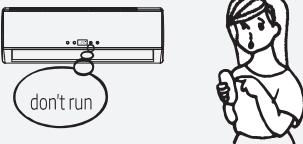
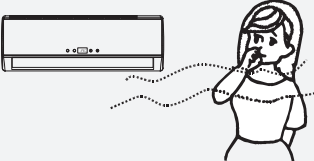
The following cases may not always be a malfunction, please check it before asking for service.

Trouble	Analysis
<p>Does not run</p> 	<ul style="list-style-type: none"> <li>• If the protector trip or fuse is blown.</li> <li>• Please wait for 3 minutes and start again, protector device may be preventing unit to work.</li> <li>• If batteries in the remote controller exhausted.</li> <li>• If the plug is not properly plugged.</li> </ul>
<p>No cooling or heating air</p> 	<ul style="list-style-type: none"> <li>• Is the air filter dirty?</li> <li>• Are the intakes and outlets of the air conditioner blocked?</li> <li>• Is the temperature set properly?</li> </ul>
<p>Ineffective control</p> 	<ul style="list-style-type: none"> <li>• If strong interference (from excessive static electricity discharge, power supply voltage abnormality) presents, operation will be abnormal. At this time, disconnect from the power supply and connect back 2-3 seconds later.</li> </ul>
<p>Does not operate immediately</p> 	<ul style="list-style-type: none"> <li>• Changing mode during operation, 3 minutes will delay.</li> </ul>
<p>Peculiar odor</p> 	<ul style="list-style-type: none"> <li>• This odor may come from another source such as furniture, cigarette etc, which is sucked in the unit and blows out with the air.</li> </ul>

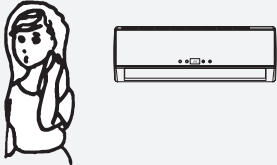
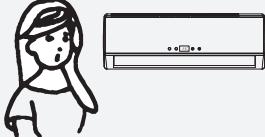
## 7 Troubleshooting

<p>A sound of flowing water</p> 	<ul style="list-style-type: none"><li>• Caused by the flow of refrigerant in the air conditioner, not a trouble.</li><li>• Defrosting sound in heating mode.</li></ul>
<p>Cracking sound is heard</p> 	<ul style="list-style-type: none"><li>• The sound may be generated by the expansion or contraction of the front panel due to change of temperature.</li></ul>
<p>Spray mist from the outlet</p> 	<ul style="list-style-type: none"><li>• Mist appears when the room air becomes very cold because of cool air discharged from indoor unit during <b>Cooling</b> or <b>Dry</b> operation mode.</li></ul>
<p>The compressor indicator (red) lights on constantly, and indoor fan stops.</p>	<ul style="list-style-type: none"><li>• The unit is shifting from heating mode to defrost. The indicator will lights off within ten minutes and returns to heating mode.</li></ul>

## 8 Identification of parts

Indoor unit

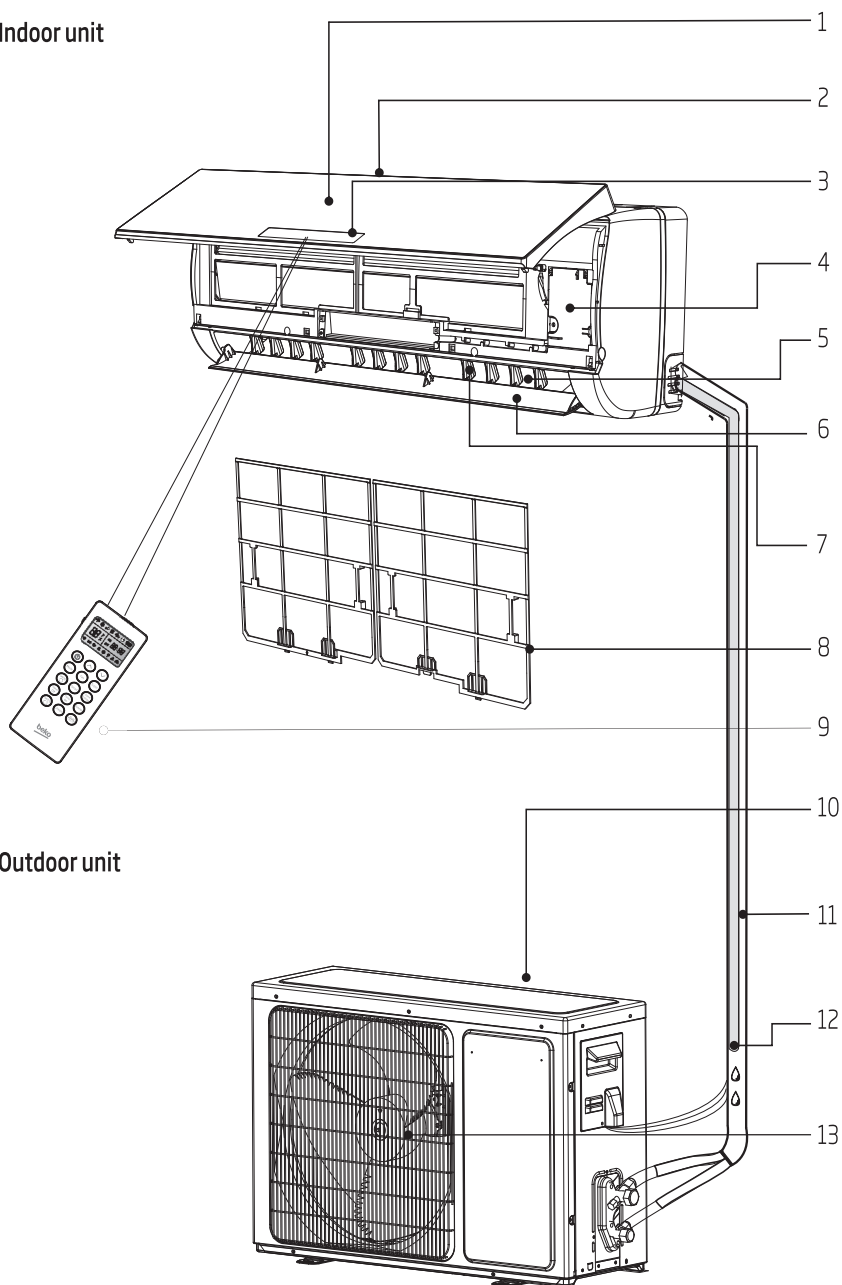

Outdoor unit

## 8 Identification of parts

1. Front panel
2. Air intake
3. Display panel
4. Emergency panel
5. Air outlet
6. Vertical adjustment louver
7. Horizontal adjustment louver
8. Air filter
9. Remote controller
10. Air intake
11. Pipes and power connection cord
12. Drain hose
13. Air Outlet



**Note:** Condensate water drains at Cooling or Dry operation.



**Note:** The figures in this manual are based on the external view of a standard model. Consequently, the shape may differ from that of the air conditioner you have selected.

## 9 Display introduction

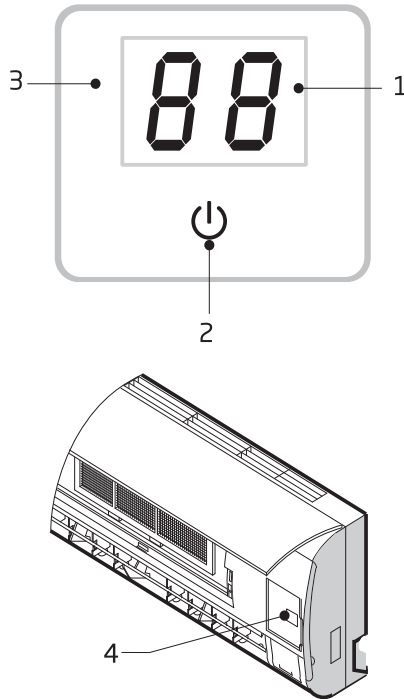

1. Temperature indicator  
Display set temperature.  
It shows FC after 200 hours of usage as reminder to clean the filter.  
After filter cleaning press the filter reset button located on the indoor unit behind the front panel in order to reset the display. (optinal)
2. Running indicator  
It lights up when the AC is running.  
It flashes during defrosting.
3. Signal receptor
4. Emergency button  
**ON/OFF:** To let the AC run or stop by pressing the button.



**Note:** The symbols may be different from these models, but the functions are similar.

## 10 BLFOM spec sheet

Model name	Indoor unit	BLFOM 090	BLFOM 120	BLFOM 180
	Outdoor unit	BLFOM 091	BLFOM 121	BLFOM 181
Refrigerant		R32	R32	R32
Total Refrigerant Amount (g)		390	560	1000
Protection against electric shock		Class I	Class I	Class I
Climate Class		T1	T1	T1
Heating Type		Cooling only	Cooling only	Cooling only
Power Supply Connection		Indoor	Indoor	Indoor
Cooling Capacity (Btu/h) [T1]		8871	11601	16719
Cooling Capacity (W) [T1]		2600	3400	4900
Heating Capacity (Btu/h)		/	/	/
Heating Capacity (W)		/	/	/
Energy Efficiency Cooling [T1]		/	/	/
Energy Efficiency Heating (W/W)		/	/	/
Power of Electric Heater (W)		/	/	/
Cooling Power Input (W) [T1]		836	1093	1644
Heating Power Input (W)		/	/	/
Voltage/Frequency (V/Hz)		220V-240V/50Hz	220V-240V/50Hz	220V-240V/50Hz
Cooling Running Current (A) [T1]		3,7	4,9	7,3
Heating Running Current (A)		/	/	/
Sound Pressure Level - Indoor Unit		38	39	45
Sound Pressure Level - Outdoor Unit		51	51	56
Air flow volume ( m3/h )		600	660	950
Rated Power Input (W)		1140	1460	2475
Rated Current Input (A)		6,1	8,0	12,5
Indoor unit Resistance Class		/	/	/
Outdoor unit Resistance Class		IPX4	IPX4	IPX4
High Pressure Pipe Diameter (mm)		Φ6,35	Φ6,35	Φ6,35
Low Pressuer Pipe Diameter (mm)		Φ9,52	Φ12,7	Φ12,7
Max. elevation (m)		10	10	10
Max. pipe length (m)		20	20	25
Additional Gas Quantity (g/m)		20	20	20
Power Supply Cord specification		3*1,0mm2	3*1,0mm2	3*1,5mm2
Indoor & Outdoor Connection Cord		3*1,0mm2	3*1,0mm2	3*1,5mm2
Indoor Unit (WxHxD) mm		903×270×218	903×270×218	1020×310×235
Outdoor Unit (WxHxD) mm		660×482×240	715x486x240	807x585x290
Indoor Unit Net Weight (kg)		8,5	9	12,5
Outdoor Unit Net Weight (kg)		24	25,5	37,5

### Note:

1. Specifications are standard values calculated based on rated operating conditions, They will vary in difference work condition.
2. Rated cooling values at T1 condition are calculated under 27/19 (In.) 35/24 (Out.) condition
3. Rated heating values are calculated under 7/6 (In.) 20/15 (Out.) condition. (For Heat pump model only)



## 10 BSVOM spec sheet

Model name	Indoor unit	BSVOM 090	BSVOM 120	BSVOM 180
	Outdoor unit	BSVOM 091	BSVOM 121	BSVOM 181
Refrigerant		R32	R32	R32
Total Refrigerant Amount (g)		430	600	710
Protection against electric shock		Class I	Class I	Class I
Climate Class		T1	T1	T1
Heating Type		Cooling only	Cooling only	Cooling only
Power Supply Connection		Indoor	Indoor	Indoor
Cooling Capacity (Btu/h) [T1]		9000	11600	17742
Cooling Capacity (W) [T1]		2638	3400	5200
Heating Capacity (Btu/h)		/	/	/
Heating Capacity (W)		/	/	/
Energy Efficiency Cooling [T1]		/	/	/
Energy Efficiency Heating (W/W)		/	/	/
Power of Electric Heater (W)		/	/	/
Cooling Power Input (W) [T1]		750	1000	1650
Heating Power Input (W)		/	/	/
Voltage/Frequency (V/Hz)		220V-240V/50Hz	220V-240V/50Hz	220V-240V/50Hz
Cooling Running Current (A) [T1]		3.4	4.4	7.2
Heating Running Current (A)		/	/	/
Sound Pressure Level - Indoor Unit		37	37	40
Sound Pressure Level - Outdoor Unit		49	49	50
Air flow volume ( m <sup>3</sup> /h )		600	650	1000
Rated Power Input (W)		1150	1350	2300
Rated Current Input (A)		6.8	8.0	12.1
Indoor unit Resistance Class		/	/	/
Outdoor unit Resistance Class		IPX4	IPX4	IPX4
High Pressure Pipe Diameter (mm)		Φ6.35	Φ6.35	Φ6.35
Low Pressuer Pipe Diameter (mm)		Φ9.52	Φ9.52	Φ12.7
Max. elevation (m)		10	10	10
Max. pipe length (m)		20	20	25
Additional Gas Quantity (g/m)		20	20	20
Power Supply Cord specification		3*1.0mm <sup>2</sup>	3*1.0mm <sup>2</sup>	3*1.5mm <sup>2</sup>
Indoor & Outdoor Connection Cord		3*1.0mm <sup>2</sup>	3*1.0mm <sup>2</sup>	3*1.5mm <sup>2</sup>
Indoor Unit (WxHxD) mm		903×270×218	903×270×218	1019×315×235
Outdoor Unit (WxHxD) mm		660×482×240	660×482×240	780×540×260
Indoor Unit Net Weight (kg)		8.5	9	12.5
Outdoor Unit Net Weight (kg)		21	22.5	26.5

### Note:



1. Specifications are standard values calculated based on rated operating conditions, They will vary in difference work condition.
2. Rated cooling values at T1 condition are calculated under 27/19 (In.) 35/24 (Out.) condition
3. Rated heating values are calculated under 7/6 (In.) 20/15 (Out.) condition. (For Heat pump model only)









