

# Dryer

## User Manual

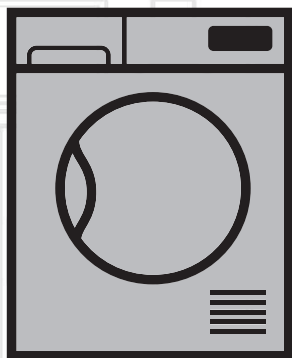

DCY 9316 W

EN

2960311486\_EN/310317.1726

CE

**beko**

# Please read this user manual first!

Dear Customer,





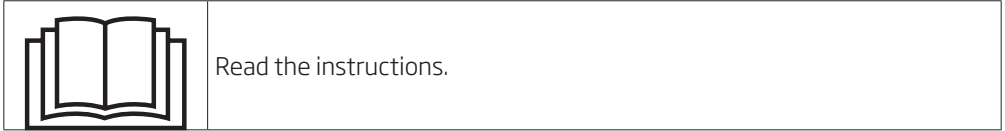

Thank you for preferring a Beko product. We hope that your product which has been manufactured with high quality and technology will give you the best results. We advise you to read through this manual and the other accompanying documentation carefully before using your product and keep it for future reference. If you transfer the product to someone else, give its manual as well. Pay attention to all details and warnings specified in the user manual and follow the instructions given therein.

Use this user manual for the model indicated on the cover page.



## Explanation of symbols

Throughout this user manual the following symbols are used:

	Important information or useful hints about usage.
	Warning for hazardous situations with regard to life and property.
	Warning against electric shock.
	Warning against hot surfaces.
	Warning against fire hazard.
	Packaging materials of the product are manufactured from recyclable materials in accordance with our National Environment Regulations.

Do not dispose of the packaging wastes with the domestic waste or other wastes, discard them to the dedicated collection points designated by the local authorities.



This product was manufactured using the latest technology in environmentally friendly conditions.

---

# 1 Important safety and environmental instructions

This section contains safety instructions that will help protect from risk of personal injury or property damage. Failure to follow these instructions shall void any warranty.

## 1.1 General safety

- The dryer can be used by children at and above 8 years old and by persons whose physical, sensory or mental capabilities were not fully developed or who lack experience and knowledge provided that they are supervised or trained on the safe usage of the product and the risks it brings out. Children should not play with the product. Cleaning and maintenance works should not be performed by children unless they are supervised by someone.
- Children of less than 3 years should be kept away unless continuously supervised.
- Adjustable feet should not be removed. The gap between the dryer and the floor should not be reduced with materials such as carpet, wood and tape. This will cause problems with the dryer.
- Always have the installation and repairing procedures carried out by the **Authorised Service**. Manufacturer shall not be held liable for damages that may arise from procedures carried out by unauthorised persons.
- Never wash the dryer by spraying or pouring water onto it! There is the risk of electric shock!

# Important instructions for safety and environment

## 1.1.1 Electrical safety



Electrical safety instructions should be followed while electrical connection is made during the installation.



The appliance must not be supplied through an external switching device, such as a timer, or connected to a circuit that is regularly switched on and off by utility.

- Connect the dryer to a grounded outlet protected by a fuse at the value specified on the type label. Have the grounding installation performed by a qualified electrician. Our company shall not be liable for any damages that will arise when the dryer is used without grounding in accordance with the local regulations.
- The voltage and allowed fuse protection is stated on the type label plate.
- The voltage specified on the type label must be equal to your mains voltage.
- Unplug the dryer when it is not in use.
- Unplug the dryer from the mains during installation, maintenance, cleaning and repair works.
- Do not touch the plug with wet hands! Never unplug by pulling on the cable, always pull out by grabbing the plug.
- Do not use extension cords, multi-plugs or adaptors to connect the dryer to power supply in order to decrease the risk of fire and electric shock.
- Power cable plug must be easily accessible after installation.



Damaged mains cable should be changed by an Authorised Service agent.



If the dryer is faulty, it must not be operated unless it is repaired by an authorised service agent! There is the risk of electric shock!

# Important instructions for safety and environment

## 1.1.2 Product safety



- Superheating of the clothes inside of the dryer can occur if you cancel the programme or in the event of a power failure whilst the dryer is running, this concentration of heat can cause self-combustion and fire so always activate the ventilation programme to cool down or quickly remove all laundry from the dryer in order to hang them up and dissipate the heat.



### **Points to be taken into consideration for fire hazard:**

Below specified laundry or items must not be dried in the dryer because of fire hazard.

- Unwashed laundry items
- Items soiled with oil, acetone, alcohol, fuel oil, kerosene, stain removers, turpentine, paraffin or solvents must be washed in hot water with plenty of detergent before being dried in the dryer.



### **Below specified laundry or items must not be dried in the dryer due to the fire hazard:**

- Garments or pillows bolstered with rubber foam (latex foam), shower caps, water resistant textiles, materials with rubber reinforcement and rubber foam pads.
  - Clothing cleaned with industrial chemicals.
- Items such as lighters, matches, coins, metal parts, needle etc. may damage the drum set or may lead to functional problems. Therefore check pockets off the laundry that you will load into your dryer. Never stop your dryer before the programme completes. If you must do this, remove all laundry quickly and lay them out to dissipate the heat.

## Important instructions for safety and environment



Clothes that are washed inadequately may ignite on their own and even may ignite after drying ends.

- You must provide enough ventilation in order to prevent gases exiting from devices operating with other types of fuels including the naked flame from accumulating in the room due to the back fire effect.



Clothing that contains metal reinforcements should not be dried in the dryer. Dryer may be damaged if metal reinforcements come loose and break off during drying.



Use softeners and similar products in accordance with the instructions of their manufacturers.



Always clean the lint filter before or after each loading. Never operate the dryer without the lint filter installed.

- Never attempt to repair the dryer by yourself. Do not perform any repair or replacement procedures on the product even if you know or have the ability to perform the required procedure unless it is clearly suggested in the operating instructions or the published service manual. Otherwise, you will be putting your life and others' lives in danger.
- There must not be a lockable, sliding or hinged door that may block the opening of the loading door in the place where your dryer is to be installed.
- Install your dryer in a suitable place that is dry, well ventilated and unlikely to get below 5 degrees Centigrade.
- Make sure that pets do not enter the dryer. Check the inside of the dryer before operating it.
- Do not lean on the loading door of your dryer when it is open, otherwise it may fall over.

## Important instructions for safety and environment

- The lint must not be allowed to accumulate around the tumble dryer.

### 1.2 Mounting over a washing machine

- A fixing device should be used between the two machines when installing the dryer above a washing machine. The fitting device can be obtained through spare part suppliers.
- Total weight of the washing machine and the dryer -with full load- when they are placed on top of each other reaches to approx. 180 kilograms. Place the products on a solid floor that has sufficient load carrying capacity!



Washing machine cannot be placed on the dryer. Pay attention to the above warnings during the installation on your washing machine.

**Installation Table for Washing Machine and Dryer**

Dryer Depth	Washing Machine Depth						
	62 cm	60 cm	54 cm	50 cm	49 cm	45 cm	40 cm
54 cm	Can be stacked					Can be stacked	Cannot be stacked
60 cm	Can be stacked					Cannot be stacked	

# Important instructions for safety and environment

## 1.3 Intended use

- Dryer has been designed for domestic use. It is not suitable for commercial use and it must not be used out of its intended use.
- Use the dryer only for drying laundry that are marked accordingly.
- The manufacturer waives any responsibility arisen from incorrect usage or transportation.
- Original spare parts will be available to repair the dryer for a period of 10 years.

## 1.4 Child safety

- Packaging materials are dangerous for the children. Keep packaging materials away from children.
- Electrical products are dangerous for the children. Keep children away from the product when it is operating. Do not let them tamper with the dryer. Use the child-proof lock in order to prevent the children to tamper with the dryer.



Child-proof lock is on the control panel.  
**(See Child lock)**

- Keep loading door closed even when the dryer is not in use.



# Important instructions for safety and environment

## 1.5 Compliance with the WEEE regulation and disposing of the waste product



This product complies with EU WEEE Directive (2012/19/EU). This product bears a classification symbol for waste electrical and electronic equipment (WEEE).

This product has been manufactured with high quality parts and materials which can be reused and are suitable for recycling. Do not dispose of the waste product with normal domestic and other wastes at the end of its service life. Take it to the collection center for the recycling of electrical and electronic equipment. Please consult your local authorities to learn about these collection centers.

## 1.6 Compliance with RoHS Directive:

The product you have purchased complies with EU RoHS Directive (2011/65/EU). It does not contain harmful and prohibited materials specified in the Directive.

## 1.7 Package information

Packaging materials of the product are manufactured from recyclable materials in accordance with our National Environment Regulations. Do not dispose of the packaging materials together with the domestic or other wastes. Take them to the packaging material collection points designated by the local authorities.

# Important instructions for safety and environment



## 1.8 Technical Specifications

EN	
Height (Min. / Max.)	84,6 cm / 86,6 cm*
Width	59,5 cm
Depth	60,9 cm
Capacity (max.)	9 kg**
Net weight (plastic front door usage)	37,5 kg
Net weight (glass front door usage)	40 kg
Voltage	See type label***
Rated power input	
Model code	

\* Min. height: Height with adjustable feet are closed.  
Max. height: Height with adjustable feet are opened maximum.

\*\* Dry laundry weight before washing.

\*\*\* For the location of the type label on the dryer (**see 2.1 Overview.**)

	Technical specifications of the dryer are subject to specification without notice to improve the quality of the product.
	Figures in this manual are schematic and may not match the product exactly.
	Values stated on markers on the dryer or in the other published documentation accompanying with the dryer are obtained in laboratory in accordance with the relevant standards. Depending on operational and environmental conditions of the dryer, these values may vary.

## Your Dryer

### 2.1 Package Contents

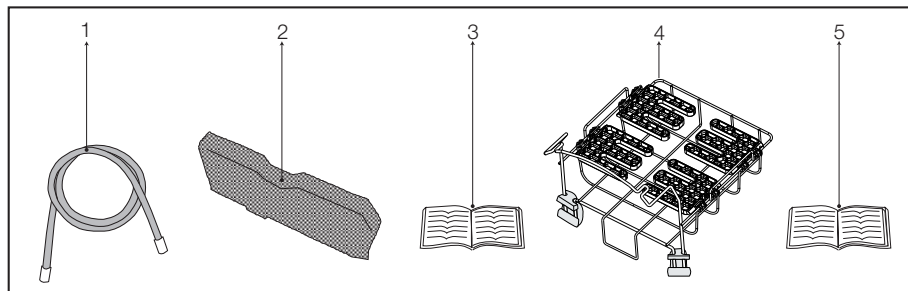

1. Water drain hose \*
2. Filter drawer spare sponge\*
3. User Manual
4. Drying basket\*
5. Drying basket user manual\*

\*It can be supplied with your machine depending on its model.

## 3 Installation

Before the calling the nearest Authorized Service for the installation of the dryer, ensure that electrical installation and water drain is appropriate referring to the user's manual. **(See 3.3 Connecting to the drain and 3.5 Electrical connection)** If they are not suitable, contact a qualified electrician and technician to make necessary arrangements.



Preparation of the dryer's location as well as the electrical and waste water installations is under customer's responsibility.



Prior to installation, visually check if the dryer has any defects on it. If the drier is damaged, do not have it installed. Damaged products cause risks for your safety.

### 3.1 Appropriate installation location

Install the dryer on a stable and level surface. Dryer is heavy. Do not move it by yourself.

- Operate your dryer in a well ventilated, dust-free environment.
- The gap between the dryer and the surface should not be reduced by the materials such as carpet, wood and tape.
- Do not cover the ventilation grills of the dryer.
- There must not be a lockable, sliding or hinged door that may block the opening of the loading door in the place where your dryer is to be installed.
- Once the dryer is installed, it should stay at the same place where its connections have been made. When installing the dryer, make sure that its rear wall does not touch anywhere (tap, socket, etc.).
- Place the dryer at least 1 cm away from the edges of other furniture.
- Your dryer can be operated at temperatures between +5°C and +35°C. If the operating conditions fall outside of this range, operation of the dryer will be adversely affected and it can get damaged.
- The rear surface of the tumble dryer shall be placed against a wall.



Do not place the dryer on the power cable.

### 3.2 Removing the transportation safety assembly



Remove the transportation safety assembly before using the dryer for the first time.

Open the loading door.

There is a nylon bag inside the drum that contains a piece of styrofoam. Hold it from its section marked with **XX XX**.

Pull the nylon towards yourself and remove the transportation safety assembly.

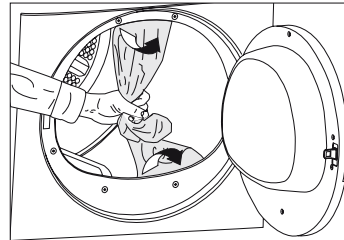

Check that no part of the transportation safety assembly remains inside the drum.

### 3.3 Connecting to the drain

In products equipped with condenser unit, water accumulates in the water tank during the drying cycle. You should drain accumulated water after each drying cycle.

You can directly drain accumulated water through the water drain hose supplied with the product instead of periodically draining the water collected in the water tank. Please refer to the detailed instructions supplied with the accessories pack.

#### Connecting the water drain hose

- 1-2** Pull hose at the behind of the dryer by hand in order to disconnect it from where it is connected. Do not use any tools to remove the hose.
- 3** Connect one end of the drain hose supplied with the dryer to the connection point from where you removed the hose of the product in previous step.
- 4** Connect the other end of the drain hose directly to the wastewater drain or to the washbasin.

## Installation

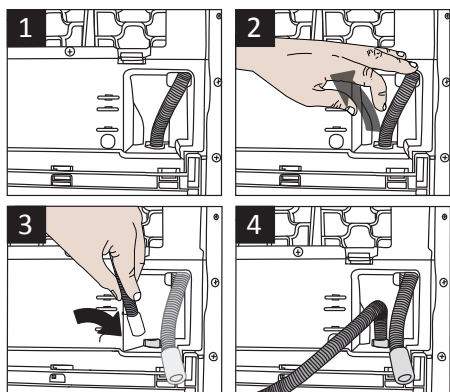

Hose connection should be made in a safe manner. Your drain house will be flooded if the hose comes out of its housing during water discharge.



Water drain hose should be attached to a height of maximum 100 cm.



Make sure that the water drain hose is not stepped on and it is not folded between the drain and the machine.

### 3.4 Adjusting the feet

In order to ensure that the dryer operates more silently and vibration-free, it must stand level and balanced on its feet. Balance the machine by adjusting the feet.

Turn the feet to left or right until the dryer stands level and firmly.

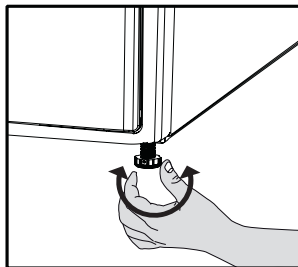

Never unscrew the adjustable feet from their housings.

### 3.5 Electrical connection

For specific instructions for electrical connection required during installation (See 1.1.1 Electrical Safety)

### 3.6 Transportation of the dryer

Unplug the dryer before transporting it. Drain all water that has remained in the dryer. If direct water drain connection is made, then remove the hose connections.



We recommend carrying the dryer in upright position. If it is not possible to carry the machine in the upright position, we recommend carrying it by tilting towards the right side when looked from the front.

### 3.7 Changing the illumination lamp

In case an illumination lamp is used in your laundry dryer. To change the Bulb/LED used for illumination of your tumble dryer, call your Authorized Service.

The lamp(s) used in this appliance is not suitable for household room illumination. The intended purpose of this lamp is to assist the user to place laundry in the tumble dryer in a comfortable way. The lamps used in this appliance have to withstand extreme physical conditions such as vibrations and temperatures above 50 °C.

## 4 Preparation

### 4.1 Laundry suitable for drying in the dryer

Always obey the instructions given on the garment tags. Dry only the laundry having a label stating that they are suitable for drying in a dryer and make sure that you select the appropriate programme.

LAUNDRY DRYING SYMBOLS											
	Drying Symbols										
	Drying Settings										
	Iron -										
<b>IRON</b>	Dry or Steam		Iron at high temperature	Iron at medium temperature	Iron at low temperature	Do not iron	Iron without steam				
	Maximum temperature		200 °C	150 °C	110 °C						

### 4.2 Laundry not suitable for drying in the dryer



Delicate embroidered fabrics, woolen, silk garments, delicate and valuable fabrics, airtight items and tulle curtains are not suitable for machine drying.

### 4.3 Preparing laundry for drying

- Laundry may be tangled with each other after washing. Separate the laundry items before placing them into the dryer.
- Dry garments having metal accessories such as zippers, inside out.
- Fasten the zippers, hooks and buckles and button sheets.

### 4.4 Things to be done for energy saving

- Following information will help you use the dryer in an ecological and energy-efficient manner.
- Spin your laundry at the highest speed possible when washing them. Thus, the drying time is shortened and energy consumption is reduced.
- Sort out the laundry depending on their type and thickness. Dry the same type of laundry together. For example thin kitchen towels and table clothes dries earlier than thick bathroom towels.
- Follow the instructions in the user manual for programme selection.
- Do not open the loading door of the machine during drying unless necessary. If you must certainly open the loading door, do not to keep it open for a long time.
- Do not add wet laundry while the dryer is in operation.

## Preparation

- Clean the lint filter before or after each drying cycle.
- Clean the condenser regularly at least once every month or after every 30 drying cycles.
- Ventilate the room, where the dryer is located, well during drying.

### 4.5 Correct load capacity

Follow the instructions in the “Programme selection and consumption table”. Do not load more than the capacity values stated in the table.

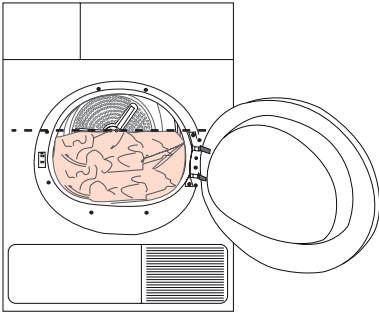

It is not recommended to load the dryer with laundry exceeding the level indicated in the figure. Drying performance will degrade when the machine is overloaded. Furthermore, dryer and the laundry can get damaged.

Following weights are given as examples:

Laundry	Approximate weights (g)*
Cotton quit covers (double)	1500
Cotton quit covers (single)	1000
Bed sheets (double)	500
Bed sheets (single)	350
Large tablecloths	700
Small tablecloths	250
Tea napkins	100
Bath towels	700
Hand towels	350
Blouses	150
Cotton shirts	300
Shirts	250
Cotton dresses	500
Dresses	350
Jeans	700
Handkerchiefs (10 pieces)	100
T-Shirts	125

\*Dry laundry weight before washing.

## 5 Operating the product

### 5.1 Control panel

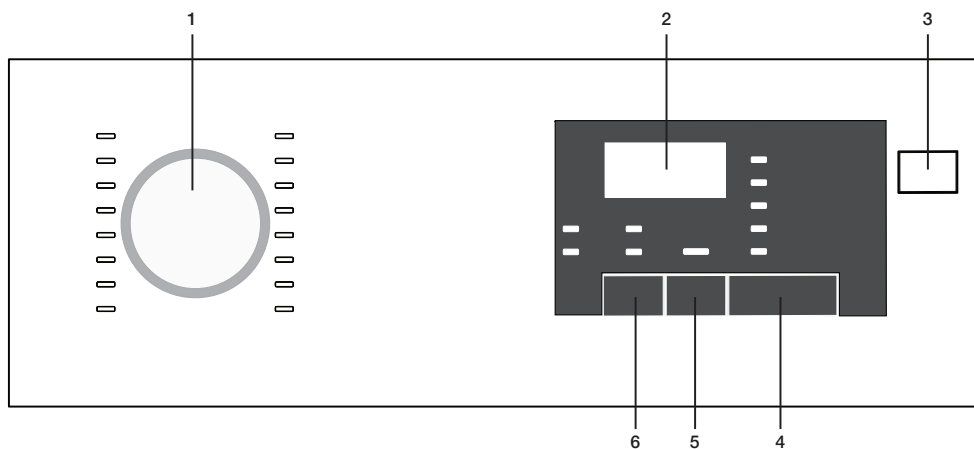

1. Programme selection knob
2. Remaining duration indicator
3. On/Off button
4. Start/pause button
5. End duration button
6. Sound warning button

### 5.2 Screen symbols

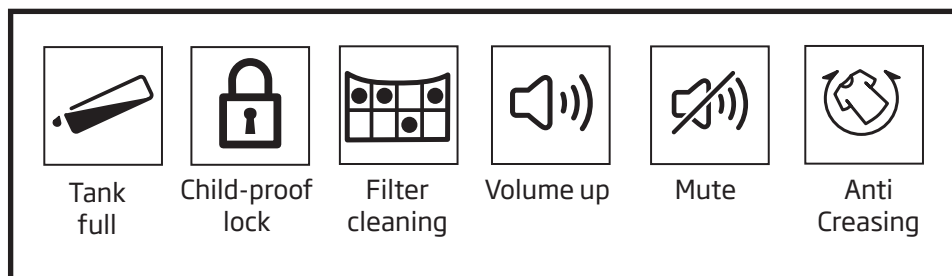



## Operating the product

### 5.3 Preparing the machine

1. Plug in the machine
2. Place laundry inside the machine.
3. Press the On/Off button.
4. When your machine turns on for the first time, it turns on with the declaration (cotton cabinet dryness) Programme.



Pressing the On/Off button doesn't mean the Programme starts.  
Press the Start / Pause button to start the Programme.

### 5.4 Programme selection

1. Determine the appropriate Programme from the chart below containing the drying levels.
2. Select the Programme you desire using the Programme Selection knob.

Extra Dry	Only cotton laundry is dried in normal temperature. Thick and multi-layered laundry (towels, sheets, jeans etc.) are dried so that they can be placed into wardrobe without ironing.
Cupboard dry	Normal laundry (tablecloths, underwear etc.) are dried so that they can be placed into wardrobe without ironing.
Cupboard dry Plus	Normal laundry (Ex: tablecloths, underwear) are again dried so that they can be placed into the wardrobe but more so than the wardrobe dryness option.
Iron Dry	Normal laundry (shirts, dresses etc) are dried ready for ironing.



For detailed Programme information see „Programme selection and consumption table“.

### 5.5 Main Programmes

The main Programmes are given below based on fabric type.

- **Cotton**

Dry durable laundry with this Programme. It dries in normal temperature. Recommended for use with your cotton laundry (sheets, bed covers, towels, bathrobes etc.)

- **Synthetic**

Dry laundry that is not very durable with this Programme. Recommended for use with your synthetic laundry.

### 5.6 Extra Programmes

The following extra Programmes are available in the machine for special conditions.



Extra Programmes may vary according to the specifications of your machine.



In order to receive better results from drying machine Programmes, your laundry should be washed with the appropriate Programme in your washing machine and wringed with recommended wringing revolution..

- **Jeans**

Use to dry jeans that are wringed with high rpm in washing machine.

- **Sport**

Used to dry the laundry that are made of synthetic, cotton or mixed fabrics and have a tag indicating that they are suitable for drying.

- **Shirts 15 min.**

Dries shirts more delicately and thus causes less wrinkles for easy ironing.

- **Baby Protect**

Programme used for baby clothing with can be dried approval on the label.



Very little dampness might remain on the shirts after the Programme. It is recommended that you do not leave the shirts in the drying machine.

## Operating the product

- **Delicates**

You can dry your delicates suitable for drying or laundry that is recommended to hand wash (silk blouses, thin underwear etc.) in low temperature.



It is recommended to dry your delicates in laundry bag to prevent wrinkles and damage. When the Programme ends, take your laundry out of the machine immediately and hang them to prevent wrinkles.

- **Freshen Up**

It only performs ventilation for 10 minutes without blowing hot air. You can ventilate the cotton and linen clothing that has remained closed for a long duration and remove their odor.

- **Timed Programmes**

You can select the 10 mins, 20 mins, 40 mins and 60 mins time Programmes to achieve the desired final drying level with low temperature.









On this Programme, the machine dries as long as the set duration, regardless of the drying level.

## Operating the product

### 5.7 Programme selection and consumption table

EN

Programs	Capacity (kg)	Spin speed in washing machine (rpm)	Approximate amount of remaining humidity	Drying time (minutes)
<b>Cottons / Coloreds</b>				
 Extra dry	9	1000	% 60	159
 Cupboard dry	9 / 4,5	1000	% 60	149 / 84
 Iron dry	9	1000	% 60	112
Shirts 15 min.	0,5	1200	% 60	15
Jeans	4	1200	%50	80
Sport	4	1000	%60	92
Delicates	2	600	%40	40
BabyProtect	3	1000	% 60	70
<b>Synthetics</b>				
 Cupboard dry	4,5	800	% 40	58
 Iron dry	4,5	800	% 40	50
<b>Energy consumption values</b>				
Programs	Capacity (kg)	Spin speed in washing machine (rpm)	Approximate amount of remaining humidity	Energy consumption value kWh
Cottons linen Ready to wear*	9 / 4,5	1000	% 60	5,12 / 2,85
Cottons Ready to iron	9	1000	% 60	4,1
Synthetics Ready to wear	4,5	800	% 40	1,9
Power consumption of the off-mode for the standart cotton programme at full load, PO (W)				0,5
Power consumption of the left-on mode for the standart cotton programme at full load, PL (W)				1,0

 „Cotton cupboard dry Programme“ used at full and partial load is the standard drying Programme to which the information in the label and the fiche relates, that this Programme is suitable for drying normal wet cotton laundry and that it is the most efficient Programme in terms of energy consumption for cotton.

\* : Energy Label standard Programme (EN 61121:2012) “All the filters must be cleaned prior to test series.” All the values in the table are determined according to EN 61121:2012 standard. Consumption values may vary from the values in the table depending on laundry type, wringing revolution, ambient conditions and changes in voltage.

## Operating the product

### 5.8 Auxiliary functions

#### Sound warning cancel

Drying machine makes sound warnings when the Programme is completed. If you don't want sound notifications, press the "Sound Notification" button.

When you press the sound notification button it lights up, and Programme does not make sound notifications when completed.



#### Loading door open

Start/Pause led blinks when the loading door of the drying machine is open.

### 5.10 End duration

You can delay the end duration of the Programme for up to 24 hours with the end duration function.

1. Open the loading door and place your laundry.
2. Select the drying Programme.
3. Press the end duration selection button and set the delay duration you want. End duration led lights up. (End duration moves continuously when you keep pressing the button).
4. Press the Start / Pause button. End duration countdown begins. The ":" sign in the middle of the displayed delay duration blinks.



You can select this function before or after the Programme starts.

#### Anti-creasing

A 2-hour anti creasing program to prevent laundry from creasing will be activated if you do not take the laundry out after the program has come to an end. This programme rotates the laundry in 10-minute intervals to prevent creasing.

### 5.9 Warning symbols



Warning symbols may vary according to the specifications of your machine.

#### Fiber filter cleaning

When the Programme is completed, a warning led lights up, which indicates that the filter has to be cleaned.

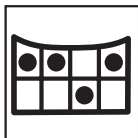

If the filter cleaning led blinks, see the „Troubleshooting“ chapter.

#### Water tank

When the Programme is completed, a warning led lights up, which indicates that the water tank must be emptied.

If the water tank fills up while the Programme is running, warning led starts blinking and the machine goes into stand-by. In that case empty the water in the water tank and start the Programme by pressing the Start / Pause button. Warning led turns off and the Programme resumes.



You can add or remove laundry for the duration of the end duration. The duration displayed on the screen is the sum of the normal drying duration and the end duration. At the end of the countdown the end duration led turns off, drying beings and drying led lights up.

#### Changing the end duration

If you want to change the duration during the countdown:

1. Cancel the Programme by pressing the On/Off button. Turn on the drying machine again by pressing the On/Off button. When your drying machine turns on for the first time, it turns on with the declaration (cotton wardrobe dryness) Programme.
2. Select the Programme you desire using the Programme Selection knob.
3. Repeat the end duration operation for the duration you want.
4. Start the Programme by pressing the Start / Pause button.

## Operating the product

### Canceling the end duration function

If you want to cancel the end duration setting countdown and start the Programme right away:

1. Cancel the Programme by pressing the On/Off button. Turn on the drying machine again by pressing the On/Off button. When your drying machine turns on for the first time, it turns on with the declaration (cotton wardrobe dryness) Programme.
2. Select the Programme you desire using the Programme Selection knob.
3. Start the Programme by pressing the Start / Pause button.

### 5.11 Starting the Programme

Start the Programme by pressing the Start / Pause button.

Start/Pause led and the Drying led light up, indicating the Programme started. The ":" sign in the middle of the remaining duration starts to blink.

### 5.12 Child Lock

The machine features a child lock which prevents the machine Programme flow from being affected when buttons are pressed during operation.

When the Child Lock is active, all buttons except for the On/Off button are deactivated. To activate the child lock, press the Sound Notification button and End Duration button simultaneously for 3 seconds.

The child lock should be deactivated to be able to start a new Programme after the current Programme ends or to be able to interfere with the current Programme. Keep the same buttons pressed for 3 seconds again to deactivate the child lock.



The lock led on the screen lights up when the Child Lock is activated.



Child Lock deactivates when the machine is turned off and on again using the On/Off button.

A warning sound is heard when any button is pressed (except for On/Off button) or the Programme Selection knob is turned while the child lock is active.

### 5.13 Changing the Programme after it is started

After the machine starts running, you can change the Programme you selected to dry your laundry with a different Programme.

1. For example, to select Extra Dry Programme instead of the Iron Dryness, stop the Programme by pressing the Start / Pause button.
2. Turn the Programme Selection knob to select the Extra Dry Programme.
3. Start the Programme by pressing the Start / Pause button.

### Adding and removing laundry in stand-by mode

If you want to add or remove laundry after the drying Programme starts:

1. Press the Start/Pause button to take the machine into Stand-by mode. Drying operation stops.
2. Open the loading door, add or remove laundry and close the loading door.
3. Start the Programme by pressing the Start / Pause button.



The laundry adding made after the drying operation started may cause the dried laundry inside the machine to mix with the wet laundry and the laundry to remain damp after the operation ends..



Laundry adding and removing can be repeated as much as desired during drying operation. But this process would continuously interrupt the drying operation, and so would cause the Programme duration to lengthen and increase energy consumption. Thus, it is recommended to add laundry before the Programme starts.



If a new Programme is selected by changing the position of the Programme selection knob while your machine is in stand-by mode, the running Programme ends.

## Operating the product



Do not contact the inner surface of the drum when adding or removing laundry during a continuing Programme. The drum surface is hot.

### 5.14 Cancelling the Programme

If you want to cancel the Programme and end the drying operation for any reason after the machine starts running, press the On/Off button.



As it will be extremely hot inside the machine when you cancel the Programme while the machine is in operation; run the ventilation Programme to cool it down.

### 5.15 Programme end

When the Programme ends, the Final/Wrinkle Prevention, Fiber Filter Cleaning and Water Tank Warning leds on the Programme follow up indicator light up. Loading door can be opened and machine becomes ready for a second run.

Press the On/Off button to turn off the machine.



In case the laundry is not removed after the Programme is completed, the wrinkle prevention Programme that lasts 2 hours start in order to prevent wrinkling of the laundry that remains inside the machine.



Clean the fibre filter after each drying. (See. „Fibre filter and loading door inner surface“)



Empty the water tank after each drying. (See. „Emptying the water tank“)

## 6 Maintenance and cleaning

Service life of product extends and frequently experienced problems will be reduced if it is cleaned at regular intervals.

### 6.1 Cleaning Lint Filter / Loading Door Inner Surface

Lint and fiber released from the laundry to the air during the drying cycle are collected in the Lint Filter.



Such fiber and lint are generally formed during wearing and washing.



Always clean the lint filter and the inner surfaces of the loading door after each drying process.



You can clean the lint filter housing with a vacuum cleaner.

To clean the lint filter:

- Open the loading door.
- Remove the lint filter by pulling it up and open the lint filter.
- Clean lint, fiber, and cotton raveling by hand or with a soft piece of cloth.
- Close the lint filter and place it back into its housing.

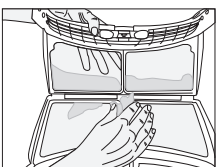
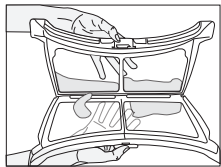
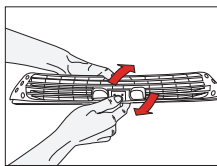
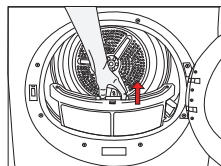

- A layer can build up on the filter pores that can cause clogging of the filter after using the dryer for a while. Wash the lint filter with warm water to remove the layer that builds up on the lint filter surface. Dry the lint filter completely before reinstalling it.

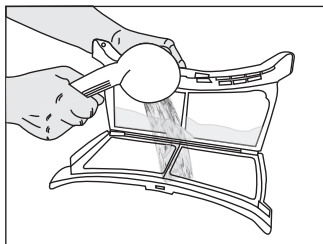

- Clean the entire inner surface of the loading door and loading door gasket with a soft damp cloth.

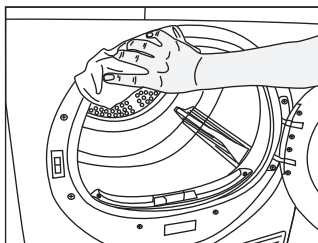
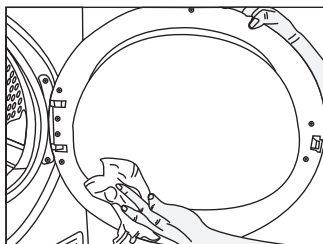

## Maintenance and cleaning

### 6.2 Cleaning the sensor

There are dampness sensors in the dryer that detect whether the laundry is dry or not. To clean the sensors:

- Open the loading door of the dryer.
- Allow the machine to cool down if it is still hot due to the drying process.
- Wipe the metal surfaces of the sensor with a soft cloth, dampened with vinegar and dry them.



Clean metal surfaces of the sensors 4 times a year.



Do not use metal tools when cleaning metal surfaces of the sensors.



Never use solvents, cleaning agents or similar substances for cleaning due to the risk of fire and explosion!

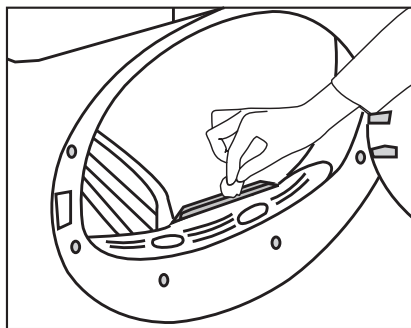

### 6.3 Draining the water tank

Dampness of the laundry is removed and condensed during drying process and the water that arise accumulates in the water tank. Drain the water tank after each drying cycle.



Condensed water is not drinkable!



Never remove the water tank when the program is running!

If you forget to drain the water tank, the machine will stop during the subsequent drying cycles when the water tank is full and the Water Tank warning symbol will flash. If this is the case, drain the water tank and press **Start / Pause** button to resume the drying cycle.

To drain the water tank:

Pull the drawer and remove the water tank carefully.

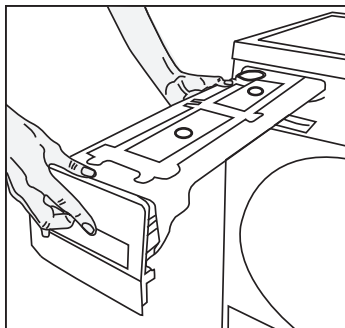

- Drain the water in the tank.

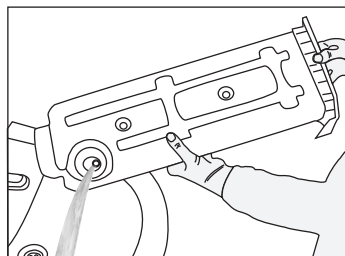

- If there is lint accumulation in the funnel of the water tank, clean it under running water.
- Place the water tank into its seat.



If the direct water draining is used as an option, there is no need to empty the water tank.



## Maintenance and cleaning

### 6.4 Cleaning the condenser;

Hot and humid air in the condenser is cooled with the cold air from the room. Thus, the humid air circulating in your dryer is condensed and then pumped into the tank.



Clean the condenser after every 30 drying cycles or once a month.

To clean the condenser:

1. If a drying process has been carried out, open the door of the machine and wait until it cools down.

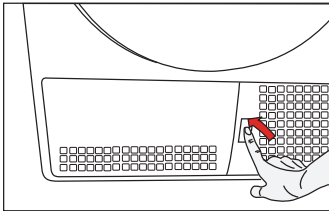

2. Unlock the 2 condenser locks after opening the kick plate.

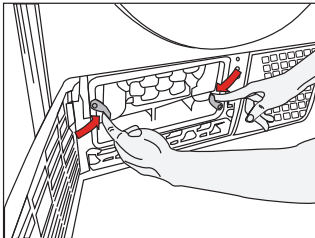

3. Pull out the condenser.

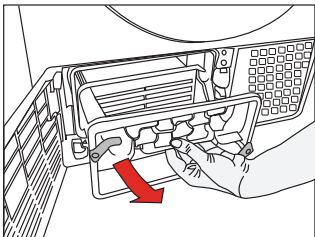

4. Clean the condenser by applying pressurized water with a shower armature and wait until the water drains.

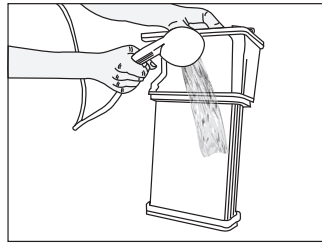

5. Place the condenser in its housing. Fasten the 2 locks and make sure that they are seated securely.

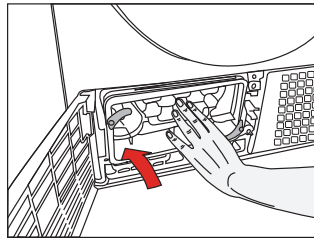

6. Close the kick plate cover.

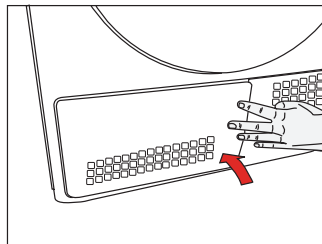

## 7 Troubleshooting

### Drying process takes too much time.

Pores of the lint filter are clogged. >>> Wash the lint filter with warm water.

- Condenser may be clogged. >>> Clean the Condenser.
- Ventilation grids on the front side of the machine are blocked. >>> Remove the objects (if any) that block ventilation in front of the ventilation grids.
- Ventilation may not be sufficient since the room where the machine is installed is very small. >>> Open the door and window of the room to avoid the room temperature increase too much.
- Lime deposit has built up on the dampness sensor. >>> Clean the dampness sensor.
- Excessive laundry might have been loaded in. >>> Do not load the dryer in excess.
- Laundry might not be spun sufficiently. >>> Spin your laundry at a higher speed in your washing machine.

### Laundry comes out wet at the end of drying.



After drying, the hot clothes feel damper than their actual dampness level.

- A programme suitable for the laundry type might have not been used. >>> Check the garment tag and select a programme suitable for the fabric type or use the timer programmes additionally.
- Pores of the lint filter are clogged. >>> Wash the lint filter with warm water.
- Condenser may be clogged. >>> Clean the Condenser.
- Excessive laundry might have been loaded in. >>> Do not load the dryer in excess.
- Laundry might not be spun sufficiently. >>> Spin your laundry at a higher speed in your washing machine.

### Dryer does not switch on or the programme does not start. Dryer does not start when it is set.

- It might have not been plugged in. >>> Make sure that the machine is plugged in.
- The loading door is ajar. >>> Make sure that the loading door is closed securely.
- Programme is not selected or the Start / Pause button is not pressed. >>> Make sure that the programme is selected and the machine is not in Pause mode.
- "Childproof lock" might have been activated. >>> Deactivate the Childproof Lock.

### Programme is interrupted without any cause.

- The loading door might not be closed securely. >>> Make sure that the loading door is closed securely.
- A power failure might have occurred. >>> Press Start / Pause button to start the program.
- Water tank may be full. >>> Drain the water tank.

### Laundry has shrunk, become felted or deteriorated.

- A programme suitable for the laundry type might have not been used. >>> Check the garment tag and select a programme suitable for the fabric type.

### Drum lighting does not turn on. (On models with lamp)

- Dryer might not be switched on with the On / Off / Cancel button. >>> Make sure that the dryer is switched on.

Bulb may have blown. >>> Call Authorized Service Agent to have the lamp replaced.

### Filter Cleaning warning symbol light is on.

- Lint filter is not cleaned. >>> Clean the lint filter.

## Troubleshooting

Lint Filter Cleaning symbol is flashing.

- Filter housing is clogged with lints. >>> Clean the lint filter housing.
- A deposit has built up on the lint filter pores that may cause clogging. >>> Wash the lint filter with warm water.
- Condenser may be clogged. >>> Clean the Condenser.

Water leaks from the loading door

- Lint has accumulated on the inner surfaces of the loading door and on the surfaces of the loading door gasket. >>> Clean the inner surfaces of the loading door and the surfaces of the loading door gasket.

Loading door opens spontaneously.

- The loading door might not be closed securely. >>> Push the loading door to close until you hear a locking sound.

Water Tank warning symbol is on/flashing.

- Water tank may be full. >>> Drain the water tank.
- Water draining hose might be bent. >>> If the product is connected directly to a wastewater drain, check the water drain hose.

Condenser cleaning warning symbol is flashing.

- Condenser might have not been cleaned. >>> Clean the Condenser.



**CAUTION:** If you cannot eliminate the problem although you follow the instructions in this section, consult your dealer or the Authorized Service Agent. Never try to repair a nonfunctional product yourself.

## PRODUCT FICHE

### Complying Commission Delegated Regulation (EU) No 392/2012

Supplier name or trademark		Beko
Model name		DCY9316W
Rated capacity (kg)		9
Type of Tumble Dryer	Air Vented	-
	Condenser	•
Energy efficiency class <sup>(1)</sup>		B
Annual Energy Consumption (kWh) <sup>(2)</sup>		616
Type of Control	Automatic	•
	Non-automatic	-
Energy consumption of the standard cotton programme at full load (kWh)		5,12
Energy consumption of the standard cotton programme at partial load (kWh)		2,85
Power consumption of the off-mode for the standart cotton programme at full load, P <sub>0</sub> (W)		0,5
Power consumption of the left-on mode for the standart cotton programme at full load, P <sub>L</sub> (W)		1,0
The duration of the left on mode (min)		30
Standard cotton programme <sup>(3)</sup>		
Programme time of the standard cotton programme at full load, T <sub>dry</sub> (min)		149
Programme time of the standard cotton programme at partial load, T <sub>dry1/2</sub> (min)		84
Weighted programme time of the standard cotton programme at full and partial load (T <sub>w</sub> )		112
Condensation efficiency class <sup>(4)</sup>		B
Average condensation efficiency of the standard cotton programme at full load, C <sub>dry</sub>		89%
Average condensation efficiency of the standard cotton programme at partial load, C <sub>dry1/2</sub>		89%
Weighted condensation efficiency of the standard cotton programme at full load and partial load, C <sub>t</sub>		89%
Sound power level for the standard cotton programme at full load <sup>(5)</sup>		66
Built-in		-

• : Yes    - : No

(1) Scale from A+++ (most efficient) to D (least efficient)

(2) Energy consumption based on 160 drying cycles of the standard cotton programme at full and partial load, and the consumption of the low-power modes. Actual energy consumption per cycle will depend on how the appliance is used.

(3) "Cotton cupboard dry programme" used at full and partial load is the standard drying programme to which the information in the label and the fiche relates, that this programme is suitable for drying normal wet cotton laundry and that it is the most efficient programme in terms of energy consumption for cotton

(4) Scale from G (least efficient) to A (most efficient)

(5) Weighted average value — L<sub>WA</sub> expressed in dB(A) re 1 pW







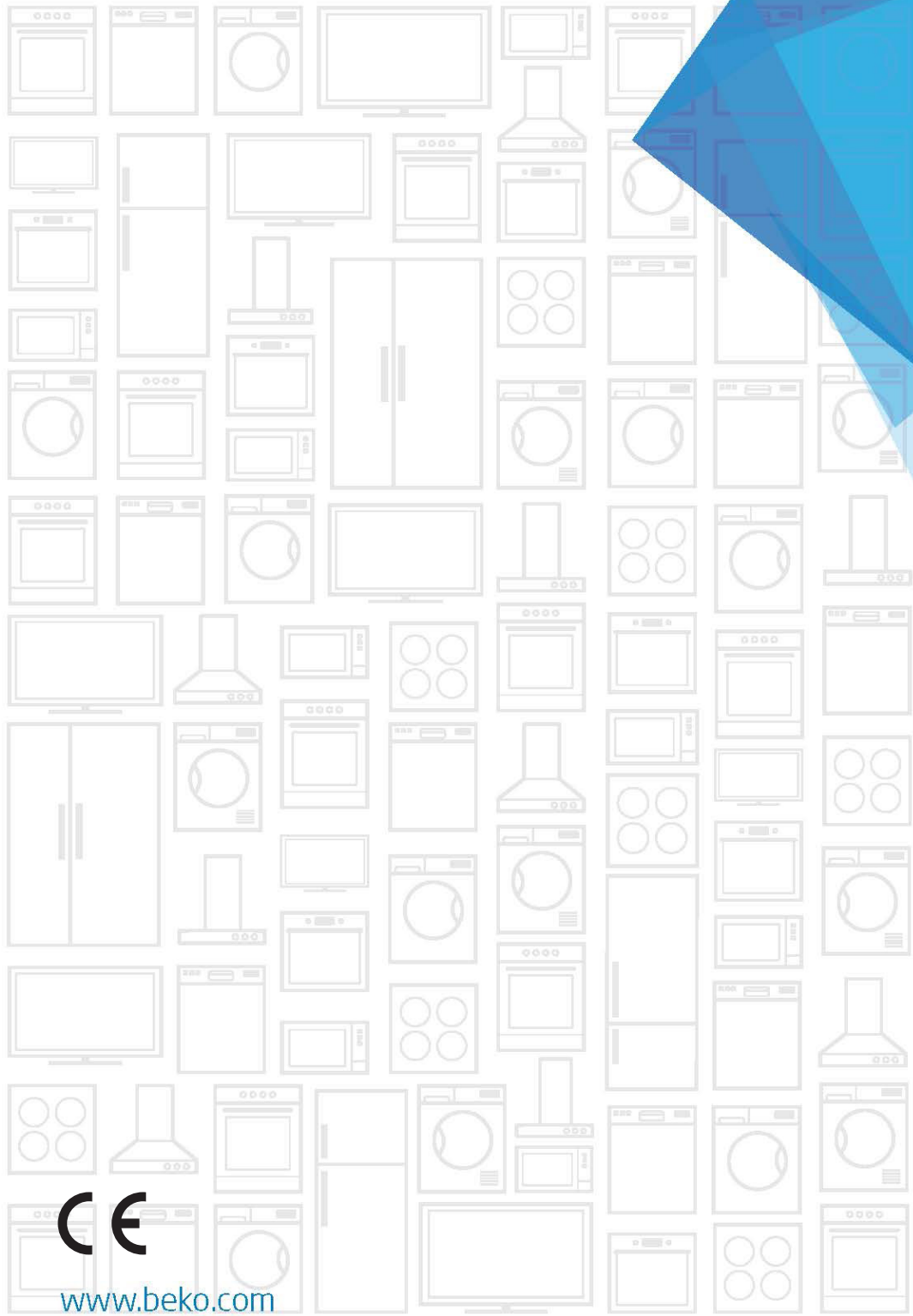

[www.beko.com](http://www.beko.com)