

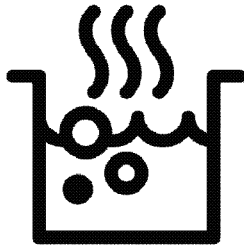

Built-in Hob
User Manual



BOCD T 6010 EGE

EN

185.2622.35/R.AA/13.02.2023/2-1

7778220292



RECYCLED &
RECYCLABLE PAPER

Please read this user manual first!

Dear Customer,

Thank you for purchasing this Beko product. We hope that you get the best results from your product which has been manufactured with high quality and state-of-the-art technology. Therefore, please read this entire user manual and all other accompanying documents carefully before using the product and keep it as a reference for future use. If you handover the product to someone else, give the user manual as well. Follow all warnings and information in the user manual.

Remember that this user manual is also applicable for several other models. Differences between models will be identified in the manual.

Explanation of symbols

Throughout this user manual the following symbols are used:



Important information or useful hints about usage.



Warning of hazardous situations with regard to life and property.



Warning of electric shock.



Warning of risk of fire.



Warning of hot surfaces.



Arçelik A.Ş.
Karaağaç caddesi No:2-6
34445 Sütlüce/İstanbul/TURKEY
Made in TURKEY

TABLE OF CONTENTS

1 Important instructions and warnings for safety and environment **4**

General safety	4
Safety when working with gas	4
Electrical safety	6
Product safety	7
Intended use	8
Safety for children	8
Disposing of the old product	8
Package information	9
Future Transportation	9

2 General information **10**

Overview	10
Package contents	10
Technical specifications	11
Injector table	11

3 Installation **13**

Before installation	13
Installation and connection	15
Gas conversion	17

4 Preparation **20**

Tips for saving energy	20
Initial use	20
First cleaning of the appliance	20

5 How to use the hob **21**

General information about cooking	21
Using the hobs	21

6 Maintenance and care **23**

General information	23
Cleaning the hob	23
Cleaning the control panel	24

7 Troubleshooting **25**

1 Important instructions and warnings for safety and environment

This section contains safety instructions that will help protect from risk of personal injury or property damage. Failure to follow these instructions shall void any warranty.

General safety

- This appliance can be used by children aged from 8 years and above and persons with reduced physical, sensory or mental capabilities or lack of experience and knowledge if they have been given supervision or instruction concerning use of the appliance in a safe way and understand the hazards involved.
Children shall not play with the appliance. Cleaning and user maintenance shall not be made by children without supervision.
- The appliance is not to be used by persons (including children) with reduced physical, sensory or mental capabilities, or lack of experience and knowledge,

unless they have been given supervision or instruction. Children should be supervised and ensure they do not play with the appliance

- If the product is handed over to someone else for personal use or second-hand use purposes, the user manual, product labels and other relevant documents and parts should be also given.
- Installation and repair procedures must always be performed by Authorised Service Agents. The manufacturer shall not be held responsible for damages arising from procedures carried out by unauthorised persons which may also void the warranty. Before installation, read the instructions carefully.
- Do not operate the product if it is defective or has any visible damage.
- Ensure that the product function knobs are switched off after every use.

Safety when working with gas

- Any works on gas equipment and systems may only be

carried out by authorised qualified persons who are Gas Safe registered.

- Prior to the installation, ensure that the local distribution conditions (nature of the gas and gas pressure) and the adjustment of the appliance are compatible.
- This appliance is not connected to a combustion products or evacuation device. It shall be installed and connected in accordance with current installation regulations. Particular attention shall be given to the relevant requirements regarding ventilation; See *Before installation, page 13*
- **CAUTION:** The use of gas cooking appliance results in the production of heat and moisture in the room in which it is installed. Ensure that the kitchen is well ventilated: keep natural ventilation holes open or install a mechanical ventilation device (mechanical extractor hood). Prolonged intensive use of the appliance may call for additional ventilation, for example increasing the level of the mechanical ventilation where present.
- Gas appliances and systems must be regularly checked for proper functioning. Regulator, hose and its clamp must be checked regularly and replaced within the periods recommended by its manufacturer or when necessary.
- Clean the gas burners regularly. The flames should be blue and burn evenly.
- This product should be used in a room which incorporates a properly adjusted and functioning Carbon Monoxide sensor. Make sure the Carbon Monoxide sensor works properly and is maintained frequently. Carbon Monoxide sensor should be installed maximum 2 meters away from the product.
- Good combustion is required in gas appliances. In case of incomplete combustion, carbon monoxide (CO) might develop. Carbon monoxide is a colourless, odourless and very toxic gas, which has a lethal effect even in very small doses.
- Request information about gas emergency telephone

numbers and safety measures in case of gas smell from you local gas provider.

- Conditions and values for gas adjustment of this product are provided on the rating/type label.

What to do when you smell gas

- Do not use open flame or do not smoke. Do not operate any electrical buttons (e.g. lamp button, door bell and etc.) Do not use fixed or mobile phones. Risk of explosion and toxication!
- Open doors and windows.
- Turn off all valves on gas appliances and gas meter at the main control valve, unless it's in a confined space or cellar.
- Check all tubes and connections for tightness. If you still smell gas leave the property.
- Warn the neighbours.
- Call the fire-brigade. Use a telephone outside the house.
- Do not re-enter the property until you are told it is safe to do so.

Electrical safety

- If the product has a failure, it should not be operated

unless it is repaired by an Authorised Service Agent. There is the risk of electric shock!

- Only connect the product to a grounded outlet/line with the voltage and protection as specified in the "Technical specifications". Have the grounding installation made by a qualified electrician while using the product with or without a transformer. Our company shall not be liable for any problems arising due to the product not being earthed in accordance with the local regulations.
- Never wash the product by spreading or pouring water onto it! There is the risk of electric shock!
- Never touch the plug with wet hands! Never unplug by pulling on the cable, always pull out by holding the plug.
- The product must be disconnected during installation, maintenance, cleaning and repairing procedures.
- If the power connection cable for the product is damaged, it must be replaced by the manufacturer, its service agent or similarly qualified

persons in order to avoid a hazard.

- The appliance must be installed so that it can be completely disconnected from the mains supply. The separation must be provided by a switch built into the fixed electrical installation, according to construction regulations.
- Any work on electrical equipment and systems should only be carried out by authorised and qualified persons.
- In case of any damage, switch off the product and disconnect it from the mains. To do this, turn off the fuse at home.
- Make sure that fuse rating is compatible with the product.

Product safety

- **WARNING:** The appliance and its accessible parts become hot during use. Care should be taken to avoid touching heating elements. Children less than 8 years of age shall be kept away unless continuously supervised.
- Never use the product when your judgment or coordination is impaired by

the use of alcohol and/or drugs.

- Be careful when using alcoholic drinks in your dishes. Alcohol evaporates at high temperatures and may cause fire since it can ignite when it comes into contact with hot surfaces.
- Do not place any flammable materials close to the product as the sides may become hot during use.
- Keep all ventilation slots clear of obstructions.
- Do not use steam cleaners to clean the appliance as this may cause an electric shock.
- **WARNING:** Unattended cooking on a hob with fat or oil can be dangerous and may result in fire. NEVER try to extinguish a fire with water, but switch off the appliance and then cover flame e.g. with a lid or a fire blanket.
- **CAUTION:** The cooking process has to be supervised. A short term cooking process has to be supervised continuously.
- **WARNING:** Danger of fire: Do not store items on the cooking surfaces.
- **WARNING:** If the surface is cracked, switch off the

appliance to avoid the possibility of electric shock.

- In case of hotplate glass breakage : Immediately shut off all burners and any electrical heating element and isolate the appliance from the power supply. Do not touch the appliance surface. Do not use the appliance.

Prevention against possible fire risk!

- Ensure all electrical connections are secure and tight to prevent risk of arcing.
- Do not use damaged cables or extension cables.
- Ensure liquid or moisture is not accessible to the electrical connection point.
- To prevent gas leakage ensure that the gas connection is sound.

Intended use

- This product is designed for domestic use. Commercial use will void the guarantee.
- **CAUTION:** This appliance is for cooking purposes only. It must not be used for other purposes, for example room heating.
- The manufacturer shall not be liable for any damage

caused by improper use or handling errors.

Safety for children

- **WARNING:** Accessible parts may become hot during use. Young children should be kept away.
- The packaging materials will be dangerous for children. Keep the packaging materials away from children. Please dispose of all parts of the packaging according to environmental standards.
- Electrical and/or gas products are dangerous to children. Keep children away from the product when it is operating and do not allow them to play with the product.
- Do not place any items above the appliance that children may reach for.

Disposing of the old product

Compliance with the WEEE Directive and Disposing of the Waste Product:



This product complies with EU WEEE Directive (2012/19/EU). This product bears a classification symbol for waste electrical and electronic equipment (WEEE).

This product has been manufactured with high quality parts and materials which can be reused and are suitable for recycling. Do not dispose of the waste product with normal domestic and other wastes at the end of its service life. Take it to the

collection center for the recycling of electrical and electronic equipment. Please consult your local authorities to learn about these collection centers.

Compliance with RoHS Directive:

The product you have purchased complies with EU RoHS Directive (2011/65/EU). It does not contain harmful and prohibited materials specified in the Directive.

Package information

- Packaging materials of the product are manufactured from recyclable materials in accordance with our National Environment Regulations. Do not dispose of the packaging materials together with the domestic or other wastes. Take them

to the packaging material collection points designated by the local authorities.

Future Transportation

- Keep the product's original carton and transport the product in it. Follow the instructions on the carton. If you do not have the original carton, pack the product in bubble wrap or thick cardboard and tape it securely.
- Secure the caps and pan supports with adhesive tape.



Check the general appearance of your product for any damages that might have occurred during transportation.

2 General information

Overview

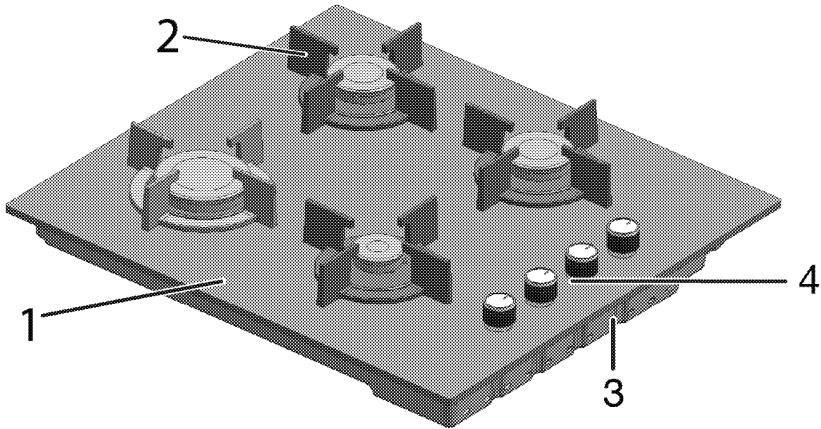

- | | |
|------------------|-----------------|
| 1 Tempered glass | 3 Base cover |
| 2 Pan support | 4 Control panel |

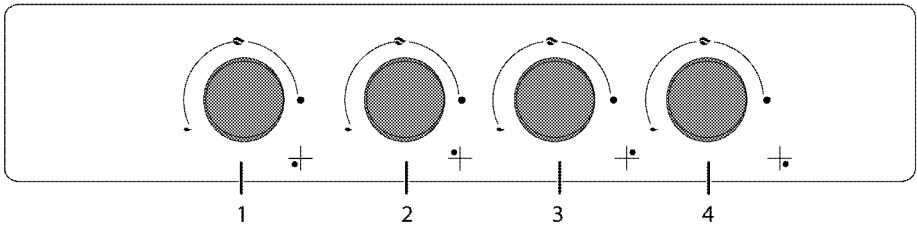

- | | |
|--------------------------------|----------------------------|
| 1 Auxiliary burner Front right | 3 Normal burner Rear left |
| 2 Rapid burner Front left | 4 Normal burner Rear right |

Package contents

i Accessories supplied can vary depending on the product model. Not every accessory described in the user manual may exist on your product.

1. User manual

2. Coffee pot adaptor

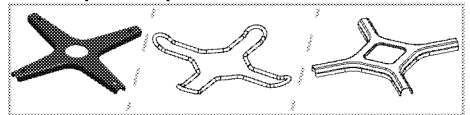

Used for coffee pots.

Technical specifications

Voltage / frequency	220-240 V ~ 50 Hz
Cable type / section	min.H05V2V2-F 3 x 0,75 mm ²
Installed gas type / pressure of the product	LPG G 30 /28-30 mbar
Total gas consumption	7.4 kW
Converting the gas type / pressure ^s optional	NG G 20/20 mbar
External dimensions (height / width / depth)	46 mm/590 mm/524 mm
Installation dimensions (width / depth)	560 mm/480-490 mm
Burners	
Front right	Auxiliary burner
Power	1 kW
Front left	Rapid burner
Power	2.9 kW
Rear left	Normal burner
Power	1.75 kW
Rear right	Normal burner
Power	1.75 kW

i Technical specifications may be changed without prior notice to improve the quality of the product.

i Figures in this manual are schematic and may not exactly match your product.

i Values stated on the product labels or in the documentation accompanying it are obtained in laboratory conditions in accordance with relevant standards. Depending on operational and environmental conditions of the product, these values may vary.

Injector table

Position hob zone	1 kW Front right	2.9 kW Front left	1.75 kW Rear left	1.75 kW Rear right
Gas type / Gas pressure				
G 20/20 mbar	72	115	97	97
G 30/28-30 mbar	50	87	66	66

You can obtain the injectors which were not provided with your product, from the authorised service provider.

Country gas categories/types/pressure

You can find the gas type, pressure and gas category that can be used for the country where the product will be installed in the table below.

COUNTRY CODES	CATEGORY		GAS TYPE AND PRESSURE			
			G20,20 mbar	G25,25 mbar	G30,28 30 mbar	G31,37 mbar
FR	Cat II	2E+3+	G20,20 mbar	G25,25 mbar	G30,28 30 mbar	G31,37 mbar
BE	Cat II	2E+3+	G20,20 mbar	G25,25 mbar	G30,28 30 mbar	G31,37 mbar
RU	Cat II	2H3B/P	G20,20 mbar	G30,30 mbar	G20,13 mbar	G20,10 mbar
CZ	Cat II	2H3+	G20,20 mbar	G30,28 30 mbar	G31,37 mbar	

COUNTRY CODES	CATEGORY		GAS TYPE AND PRESSURE			
NL	Cat II	2E(43.46 - 45.3 MJ/m ³ (0°C))3B/P	G25,3,25 mbar	G20,20 mbar	G30,30 mbar	
	Cat II	2L3B/P	G25,25 mbar	G20,20 mbar	G30,30 mbar	
GB	Cat II	2H3+	G20,20 mbar	G30,28 30 mbar	G31,37 mbar	
IE	Cat II	2H3+	G20,20 mbar	G30,28 30 mbar	G31,37 mbar	
ES	Cat II	2H3+	G20,20 mbar	G30,28 30 mbar	G31,37 mbar	
PT	Cat II	2H3+	G20,20 mbar	G30,28 30 mbar	G31,37 mbar	
CH	Cat II	2H3+	G20,20 mbar	G30,28 30 mbar	G31,37 mbar	
IT	Cat II	2H3+	G20,20 mbar	G30,28 30 mbar	G31,37 mbar	
SK	Cat II	2H3+	G20,20 mbar	G30,28 30 mbar	G31,37 mbar	
CY	Cat II	2H3+	G20,20 mbar	G30,28 30 mbar	G31,37 mbar	
SI	Cat II	2H3+	G20,20 mbar	G30,28 30 mbar	G31,37 mbar	
GR	Cat II	2H3+	G20,20 mbar	G30,28 30 mbar	G31,37 mbar	
PL	Cat II	2ELS3B/P	G20,20 mbar	G2.350,13 mbar	G30,37 mbar	
	Cat II	2E3P(B/P)	G20,20 mbar	G30,37 mbar		
DE	Cat II	2E3B/P	G20,20 mbar	G30,50 mbar		
AT	Cat II	2H3B/P	G20,20 mbar	G30,50 mbar		
SE	Cat II	2H3B/P	G20,20 mbar	G30,30 mbar		
LT	Cat II	2H3B/P	G20,20 mbar	G30,30 mbar		
NO	Cat II	2H3B/P	G20,20 mbar	G30,30 mbar		
RO	Cat II	2H3B/P	G20,20 mbar	G30,30 mbar		
DK	Cat II	2H3B/P	G20,20 mbar	G30,30 mbar		
EE	Cat II	2H3B/P	G20,20 mbar	G30,30 mbar		
MA	Cat II	2H3B/P	G20,20 mbar	G30,30 mbar		
FI	Cat II	2H3B/P	G20,20 mbar	G30,30 mbar		
HR	Cat II	2H3B/P	G20,20 mbar	G30,30 mbar		
TR	Cat II	2H3B/P	G20,20 mbar	G30,30 mbar		
MT	Cat I	3B/P	G30,30 mbar			
IS	Cat I	2H	G20,20 mbar			
LV	Cat I	2H	G20,20 mbar			
LU	Cat I	2E	G20,20 mbar			
BG	Cat I	2H	G20,20 mbar			
	Cat I	3B/P	G30,30 mbar			
HU	Cat I	2H	G20,25 mbar			
	Cat I	3B/P	G30,30 mbar			

3 Installation

Product must be installed by a qualified person in accordance with the regulations in force. The manufacturer shall not be held responsible for damages arising from procedures carried out by unauthorized persons which may also void the warranty.

i Preparation of location and electrical and gas installation for the product is under customer's responsibility.

! The product must be installed in accordance with all local gas and/or electrical regulations.

! Prior to installation, visually check if the product has any defects on it. If so, do not have it installed. Damaged products cause risks for your safety.

Before installation

The hob is designed for installation into commercially available work tops. A safety

distance must be left between the appliance and the kitchen walls and furniture. See figure (values in mm).

- Allow a minimum distance of 750 mm above the hob surface.
- (*) If a cooker hood is to be installed above the cooker, refer to cooker hood manufacturer' instructions regarding installation height. If not defined any size in the hood manual, this height should be at least 650 mm.
- Remove packaging materials and transport locks.
- Surfaces, synthetic laminates and adhesives used must be heat resistant (100 °C minimum).
- The worktop must be aligned and fixed horizontally.
- Cut aperture for the hob in worktop as per installation dimensions.
- This product is a class 3 device according to EN 30-1-1 standard.

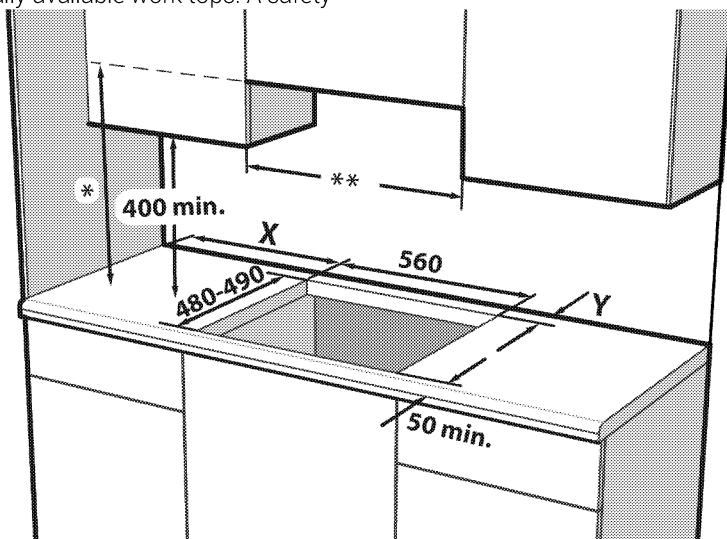

* Minimum height to extractor as recommend in hood instruction manual. If not recommended in the hood instruction manual, this height should be at least 650 mm.

** Minimum distance between cabinetry must be equal to width of hob

X -Minimum distance between the cut-out and the side wall.

Y -Minimum distance between the rear edge of the cut-out and the rear wall.

Hob Control Type	Burner Plate Type	Hob Width (mm) #	X (mm)	Y (mm)
Side knob control	Metal	580 / 610	100	50
Side knob control	Glass	590 / 600 / 601 / 641 / 646	100	60
Front knob control	Metal /Glass	580 / 585 / 590 / 600 / 601 / 641 / 646	170	50 ***
Front knob control	Metal /Glass	750 / 751	170	70

*** This size will be 60mm in models using 9-steps gas taps.

Refer to the width dimension in the technical specifications table of the user manual.

Room ventilation

All rooms require an openable window, or equivalent, and some rooms will require a permanent vent as well. The air for combustion is taken from the room air and the exhaust gases are emitted directly into the room. Good ventilation is essential for safe operation of your appliance.

Rooms with doors and/or windows which open directly to the outer environment

The doors and/or windows that open directly to the outer environment must have a total ventilation opening of the dimensions specified in the table below which is based on the total gas power of the appliance (total gas power consumption of the appliance is shown in the technical specification table of this user manual). If the doors and/or windows do not have a total ventilation opening corresponding to the total gas consumption of the appliance as specified in the table below, then there must definitely be an additional fixed ventilation opening in the room to ensure that the total minimum ventilation requirements for the total gas consumption of the appliance is achieved. The fixed ventilation opening can include openings for existing airbricks, extraction hood ducting opening dimension etc.

Total gas consumption (kW)	min. Ventilation opening (cm ²)
6-8	400
8-10	500
10-11.5	600
11.5-13	700
13-15.5	800
15.5-17	900
17-19	1000
19-24	1250

Rooms that do not have openable doors and/or windows that open directly to the outer environment

If the room where the appliance is installed does not have a door and/or a window that opens directly to the outer environment, other products shall be sought that definitely provide a fixed nonadjustable and non-closable ventilation opening which meets the total minimum ventilation opening requirements for the total gas consumption of the appliance as indicated in the above table. Also the appropriate building regulations advise should be followed.

Where a room or internal space contains more than one gas appliance, additional ventilation area shall be provided on top of the requirement given in the table above. Size of additional ventilation area shall be appropriate to regulations of other gas appliances.

There should also be a minimum clearance of 10mm on the bottom edge of the door that opens to the inner environment in the room where the appliance is installed. You

Total gas consumption (kW)	min. Ventilation opening (cm ²)
0-2	100
2-3	120
3-4	175
4-6	300

must ensure that items such as carpets and other floorcoverings etc., do not affect the clearance when the door is closed.

The cooker may be located in a kitchen, kitchen/diner or a bed-sitting room, but not in a room containing a bath or a shower.

The cooker must not be installed in a bed-sitting room of less than 20m³.

Do not install this appliance in a room below ground level unless it is open to ground level on at least one side.

Installation and connection

- The product must be installed in accordance with all local gas and electrical regulations.

Electrical connection

Connect the product to a grounded outlet/line protected by a miniature circuit breaker of suitable capacity as stated in the "Technical specifications" table. Have the grounding installation made by a qualified electrician while using the product with or without a transformer. Our company shall not be liable for any damages that will arise due to using the product without a grounding installation in accordance with the local regulations.



The product must be connected to the mains supply only by an authorised and qualified person. The product's warranty period starts only after correct installation. Manufacturer shall not be held responsible for damages arising from procedures carried out by unauthorised persons.



The power cable must not be clamped, bent or trapped or come into contact with hot parts of the product.

A damaged power cable must be replaced by a qualified electrician. Otherwise, there is risk of electric shock, short circuit or fire!

- Connection must comply with national regulations.
- The mains supply data must correspond to the data specified on the type label of

the product. Type label is at the rear housing of the product.

- Power cable of your product must comply with the values in "Technical specifications" table.



Before starting any work on the electrical installation, disconnect the product from the mains supply. There is the risk of electric shock!



Power cable plug must be within easy reach after installation (do not route it above the hob).



While performing the wiring, you must apply with the national/local electrical regulations and must use the appropriate socket outlet/line and plug for oven. In case of the product's power limits are out of current carrying capability of plug and socket outlet/line, the product must be connected through fixed electrical installation directly without using plug and socket outlet/line.

Plug the power cable into the socket.

Gas connection



Product can be connected to gas supply system only by an authorised and qualified person or technician with licence.

Risk of explosion or toxication due to unprofessional repairs!

Manufacturer shall not be held responsible for damages arising from procedures carried out by unauthorised or unlicensed persons.



Before starting any work on the gas installation, disconnect the gas supply.

There is the risk of explosion!

- Gas adjustment conditions and values are stated on labels (or on type label).
- Your product is equipped for liquefied petroleum gas (LPG).

Connecting the gas hose

- Have your product connected in a way that it will be close to the gas connection and not gas leakage will exist.
- Plastic hose to be used must not be longer than 125 cm.
- Install the clamp to the hose. Soak one end of the hose (15 mm inner diameter) into boiling water for one minute to soften it.
- Then, slip the softened end of the hose completely onto the sharp hose tip of your product. Finally, tighten the clamp completely with a screwdriver.
- Repeat the same procedure for the other end of the hose and complete the gas cylinder connection.
- Never forget to make the gas leakage control.

 Risk of explosion and suffocation!
Do not keep LPG cylinders in home.

 If you need to use your product later with a different type of gas, you must consult the Authorised Service Agent for the related conversion procedure.

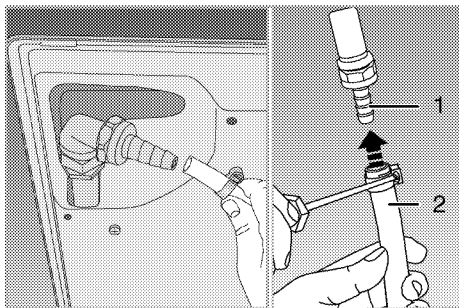



- 1 LPG hose tip
- 2 Plastic hose

Leakage check at the connection point

- Make sure that all knobs on the product are turned off. Make sure that the gas supply is open. Prepare soapy foam and apply it onto the connection point of the hose for gas leakage control.
- Soapy part will froth if there is a gas leakage. In this case, inspect the gas connection once again.

- Instead of soap, you can use commercially available sprays for gas leak check.

 Never use a match or lighter to make the gas leakage control.

 The flexible gas hose must be connected in a way that it does not contact the moving parts around it and is not trapped when the moving parts are travelling. (e.g. drawers). Besides, it should not be placed in spaces where it might get squeezed.

 The gas hose must not be clamped, bent or trapped or come into contact with hot parts of the product. There is the risk of explosion due to damaged gas hose.

Installing the product

1. Remove burners, burner caps and grills on the hob from the product.
2. Turning the hob upside down, place it on a flat surface.
3. When installing the hob, apply the sealing gasket, which was provided in the packaging, around the hob as shown in the following picture, ensuring that it remains 1 to 2 mm inside from the outer edge of the glass.

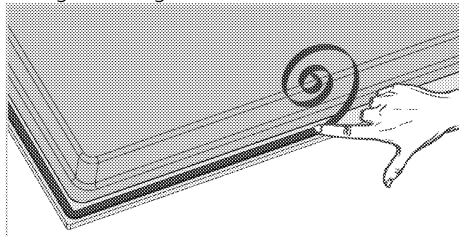

4. Place the hob on the counter and align it.

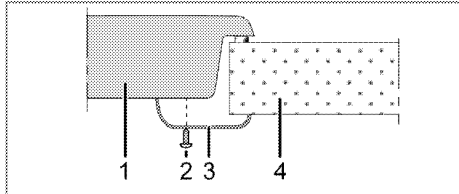

- 1 Hob
- 2 Screw

- 3 Installation clamp
- 4 Counter

i When installing the hob onto a cabinet, a shelf must be installed in order to separate the cabinet from the hob as illustrated in the above figure. This is not required when installing onto a built-under oven.

For example, if it is possible to touch the bottom of the product since it is installed onto a drawer, this section must be covered with a wooden plate.

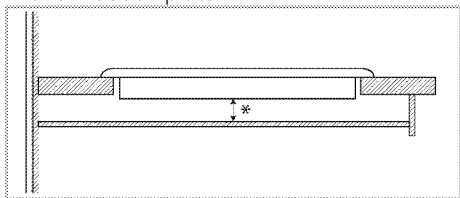

* min. 15 mm

Rear view (connection holes)

i Location of the connection holes shown in the below figure are schematic, may vary depending on the product model. Fix them according to connection holes on your product.

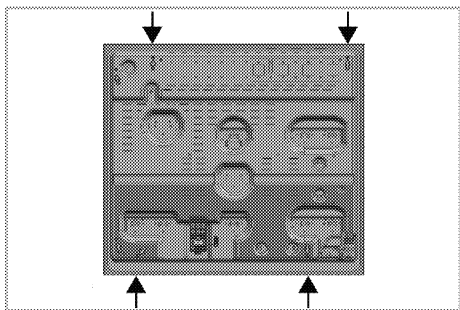

Place the burner plates, burner plate caps and grills back to their seating after installation.

! Making connections to different holes is not a good practice in terms of safety since it can damage the gas and electrical system.

! There are gas and electrical components contained within this hob, therefore when fitting the mounting springs/clamps only attach the supplied fixings to the connection holes shown in this manual. Failure to observe this advise may lead to life and property safety

Final check

1. Open gas supply.
2. Check gas installations for secure fitting and tightness.
3. Ignite burners and check appearance of the flame.

i Flame must be blue and have a regular shape. If the flame is yellowish, check if the burner cap is seated securely or clean the burner.

Gas conversion

! Before starting any work on the gas installation, disconnect the gas supply.
There is the risk of explosion!

In order to change your appliance's gas type, change all injectors and make flame adjustment for all valves at reduced flow rate position.

Exchange of injector for the burners

1. Take off burner cap and burner body.
2. Unscrew injectors by turning the counter-clockwise.
3. Fit new injectors.
4. Check all connections for secure fitting and tightness.

i New injectors have their position marked on their packing or injector table on *Injector table, page 11* can be referred to.

i ((Varies depending on the product model.))

On some hob burners, the injector is covered with a metal piece. This metal cover must be removed for injector replacement.

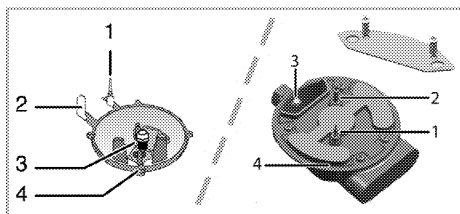

- 1 Flame failure device (model dependant)
- 2 Spark plug
- 3 Injector
- 4 Burner

i Unless there is an abnormal condition, do not attempt to remove the gas burner taps. You must call an Authorised service agent or technician with licence if it is necessary to change the taps.

Reduced gas flow rate setting for hob taps

1. Ignite the burner that is to be adjusted and turn the knob to the reduced position.
2. Remove the knob from the gas tap.
3. Use an appropriately sized screwdriver to adjust the flow rate adjustment screw.

For LPG (Butane - Propane) turn the screw clockwise. For the natural gas, you should turn the screw **counter-clockwise** once.

» The normal length of a straight flame in the reduced position should be 6-7 mm.

4. If the flame is higher than the desired position, turn the screw clockwise. If it is smaller turn anticlockwise.
5. For the last control, bring the burner both to high-flame and reduced positions and check whether the flame is on or off.

Depending on the type of gas tap used in your appliance the adjustment screw position may vary.

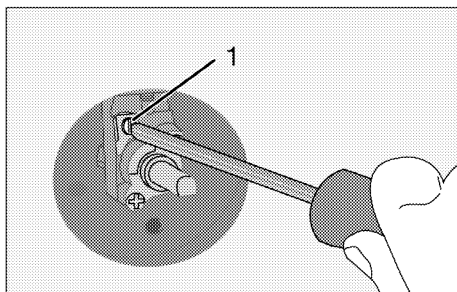

1 Flow rate adjustment screw

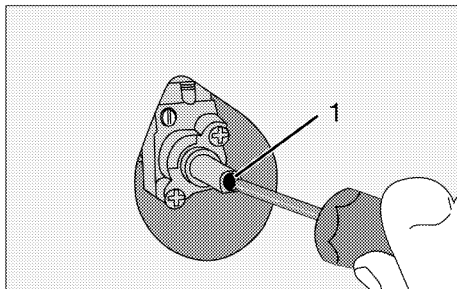

1 Flow rate adjustment screw

i If the gas type of the unit is changed, then the rating plate that shows the gas type of the unit must also be changed.

Leakage check at the injectors

Before carrying out the conversion on the product, ensure all control knobs are turned to off position. After the correct conversion of injectors, for each injectors should be gas leak checked.

1. Make sure that the gas supply to the product is on, still maintaining all control knobs turned to off position.
2. Each injector hole is blocked with a finger applying reasonable force to stop the gas leakage when corresponding control knob turned to on and it held at depressed position to allow gas reach the injector.
3. Apply prepared soapy water at the injector connection with a small brush, if there is leakage of gas at the injector connection the soapy water will begin to froth. In this case, tighten the injector with a reasonable force and repeat step 3 process once again.

4. If the froth still persist you must turn off the gas apply to the product immediately and call an Authorised service agent or technician with licence. Do not use the product until the authorized service has intervened in the product.

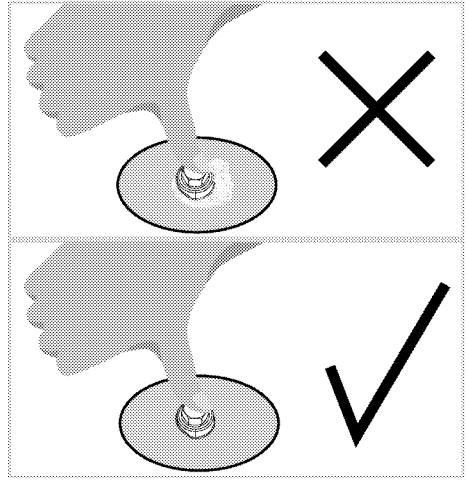
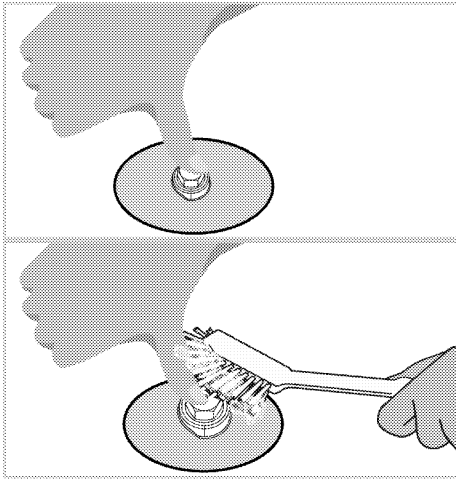

4 Preparation

Tips for saving energy

The following information will help you to use your appliance in an ecological way, and to save energy:

- Defrost frozen dishes before cooking them.
- Use pots/pans with cover for cooking. If there is no cover, energy consumption may increase 4 times.
- Select the burner which is suitable for the bottom size of the pot to be used. Always select the correct pot size for your dishes. Larger pots require more energy.
- Information on energy efficiency according to EU 66/2014 can be found on the product fiche given with the product.

Initial use

First cleaning of the appliance



The surface might get damaged by some detergents or cleaning materials.

Do not use aggressive detergents, cleaning powders/creams or any sharp objects during cleaning.

Do not use harsh abrasive cleaners or sharp metal scrapers to clean the oven door glass since they can scratch the surface, which may result in shattering of the glass.

1. Remove all packaging materials.
2. Wipe the surfaces of the appliance with a damp cloth or sponge and dry with a cloth.

5 How to use the hob

General information about cooking



Never fill the pan with oil more than one third of it. Do not leave the hob unattended when heating oil. Overheated oils bring risk of fire.

Never attempt to extinguish a possible fire with water! When oil catches fire, cover it with a fire blanket or damp cloth. Turn off the hob if it is safe to do so and call the fire department.

- Before frying foods, always dry them well and gently place into the hot oil. Ensure complete thawing of frozen foods before frying.
- Do not cover the vessel you use when heating oil.
- Place the pans and saucepans in a manner so that their handles are not over the hob to prevent heating of the handles. Do not place unbalanced and easily tilting vessels on the hob.
- Do not place empty vessels and saucepans on cooking zones that are switched on. They might get damaged.
- Operating a cooking zone without a vessel or saucepan on it will cause damage to the product. Turn off the cooking zones after the cooking is complete.
- As the surface of the product can be hot, do not put plastic and aluminum vessels on it. Such vessels should not be used to keep foods either.
- Use flat bottomed saucepans or vessels only.
- Put appropriate amount of food in saucepans and pans. Thus, you will not have to make any unnecessary cleaning by preventing the dishes from overflowing. Do not put covers of saucepans or pans on cooking zones. Place the saucepans in a manner so that they are centered on the cooking zone. When you want to move the saucepan onto another cooking zone, lift and place it onto the cooking zone you want instead of sliding it.

Gas cooking

- Size of the vessel and the flame must match each other. Adjust the gas flames so that they will not extend the bottom of the vessel and center the vessel on saucepan carrier.
- Sudden temperature changes on the glass cooking surface may cause damage, be careful not to spill cold liquids during cooking.
- Do not use large pans/pots to cover more than one burner.

Using the hobs

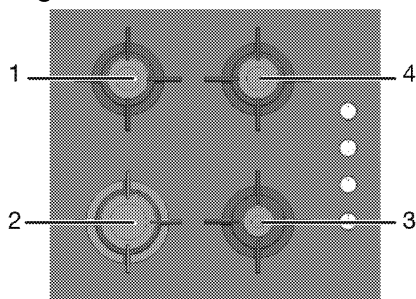

- 1 Normal burner 14-20 cm
- 2 Rapid burner 18-22 cm
- 3 Auxiliary burner 12-18 cm
- 4 Normal burner 14-20 cm is list of advised diameter of pots to be used on related burners.



Do not use cooking pans beyond the dimension limits given above. Using larger pans causes risk of carbon monoxide poisoning, overheating of adjacent surfaces and control knobs. Using smaller pans causes your risk of being burned by the flame.

 Do not use cooking pans/pots beyond the dimension limits given above. Otherwise, the glass cooking surface will overheat and the product will be damaged.

 Parts or components of your product may be damaged due to high heat during cooking with similar accessories used for making embers and not recommended in the manual. Damage caused by such use is the responsibility of the user.

Large flame symbol indicates the highest cooking power and small flame symbol indicates the lowest cooking power. In turned off position (top), gas is not supplied to the burners.

Igniting the gas burners

1. Keep burner knob pressed.
 2. Turn it counter clockwise to large flame symbol.
- » Gas is ignited with the spark created.
3. Adjust it to the desired cooking power.

Turning off the gas burners

Turn the keep warm zone knob to off (upper) position.

 In the event of the burner flames being accidentally extinguished, turn off the burner control and do not attempt to re-ignite the burner for at least 1 min.

Gas shut off safety system (in models with thermic component)

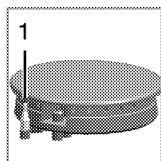

1. Gas shut off safety

As a counter measure against blow out due to fluid overflows at burners, safety mechanism trips and shuts off the gas.

- Push the knob inwards and turn it counter clockwise to ignite.
- After the gas ignites, keep the knob pressed for 3-5 seconds more to engage the safety system.
- If the gas does not ignite after you press and release the knob, repeat the same procedure by keeping the knob pressed for 15 seconds.

 Release the button if the burner is not ignited within 15 seconds. Wait at least 1 minute before trying again. There is the risk of gas accumulation and explosion!

6 Maintenance and care

General information

Service life of the product will extend and the possibility of problems will decrease if the product is cleaned at regular intervals.

! Disconnect the product from mains supply before starting maintenance and cleaning works.

There is the risk of electric shock!

! Allow the product to cool down before you clean it.

Hot surfaces may cause burns!

- Clean the product thoroughly after each use. In this way it will be possible to remove cooking residues more easily, thus avoiding these from burning the next time the appliance is used.
- No special cleaning agents are required for cleaning the product. Use warm water with washing liquid, a soft cloth or sponge to clean the product and wipe it with a dry cloth.
- Always ensure any excess liquid is thoroughly wiped off after cleaning and any spillage is immediately wiped dry.
- Do not use cleaning agents that contain acid or chloride to clean the stainless or inox surfaces and the handle. Use a soft cloth with a liquid detergent (not abrasive) to wipe those parts clean, paying attention to sweep in one direction.

i The surface might get damaged by some detergents or cleaning materials.

Do not use aggressive detergents, cleaning powders/creams or any sharp objects during cleaning.

Do not use harsh abrasive cleaners or sharp metal scrapers to clean the oven door glass since they can scratch the surface, which may result in shattering of the glass.

i Do not use steam cleaners to clean the appliance as this may cause an electric shock.

Cleaning the hob

Cleaning the burner

1. Remove the saucepan carriers from the hob.
2. Remove all removable parts of the burner and clean only by hand with sponge, some detergent and hot water.
3. Clean the non-removable parts of the burner with a wet cloth.
4. Clean the plug and thermal element (in models with ignition and thermal element) with a slightly moist cloth. Afterwards, dry with a clean cloth. Make sure that flame holes and plug are totally dry.

Otherwise, no spark occurs at the end of ignition.

5. When placing the pan supports, pay attention to place the pan supports so that the burners are centered.

Assembling the burner parts

After cleaning the burner, place the parts as shown below.

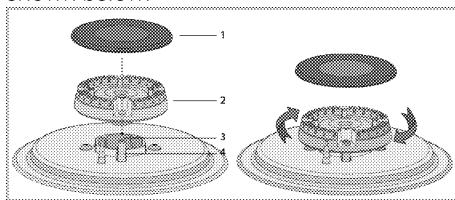

- 1 Burner cap
- 2 Burner head
- 3 Burner chamber
- 4 Spark plug (in products with igniter)

1. Place the burner head ensuring that it passes through the burner spark plug (4). Turn the burner head right and left to make sure that it is seated in the burner chamber.
2. Place the burner cap on the burner head.

Glass ceramic surface

Wipe the glass ceramic surface (vitreoceramic) with cold water, paying attention to leave no residual cleaning

agents, and dry with a soft clothing. Residues may cause damage on the glass ceramic surface when using the hob for the next time.

Dried residues on the glass ceramic surface (vitreoceramic) should under no circumstances be scraped with hook blades, steel wool or similar tools.

Remove calcium stains (yellow stains) with commercially available lime remover or a small amount of lime remover such as vinegar or lemon juice.

If the surface is heavily soiled, apply the cleaning agent on a sponge and wait until it is absorbed well. Then, clean the surface of the hob with a damp cloth.

i Sugar-based foods such as thick cream and syrup must be cleaned promptly without waiting the surface to cool down. Otherwise, glass ceramic surface may get damaged permanently.

Slight color fading may occur on coatings or other surfaces in time. This does not affect the operation of the product.

Color fading and stains on the glass ceramic surface is a normal condition, and not a defect.

Cleaning the control panel

Clean the control panel and knobs with a damp cloth and wipe them dry.

i If your product is equipped with buttons/knobs do not remove the control buttons/knobs to clean the control panel.

Control panel may get damaged!

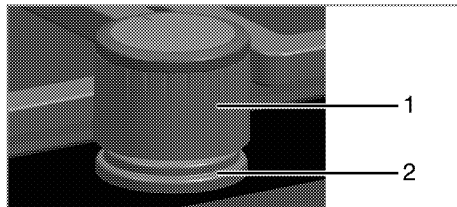

- 1 Knob
- 2 Sealing element

i Do not remove the sealing elements under the knobs for cleaning.

7 Troubleshooting

Product emits metal noises while heating and cooling.

- When the metal parts are heated, they may expand and cause noise. >>> *This is not a fault.*

There is no ignition spark.

- No current. >>> *Check fuses in the fuse box.*

There is no gas.

- Main gas valve is closed. >>> *Open gas valve.*
- Gas pipe is bent. >>> *Install gas pipe properly.*

Burners are not burning properly or at all.

- Burners are dirty. >>> *Clean burner components.*
- Burners are wet. >>> *Dry the burner components.*
- Burner cap is not mounted safely. >>> *Mount the burner cap properly.*
- Gas valve is closed. >>> *Open gas valve.*
- Gas cylinder is empty (when using LPG). >>> *Replace gas cylinder.*



Consult the Authorised Service Agent or technician with licence or the dealer where you have purchased the product if you can not remedy the trouble although you have implemented the instructions in this section. Never attempt to repair a defective product yourself.

