

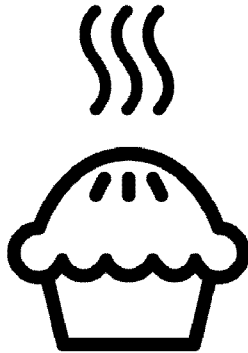

**Oven**  
User Manual



**GGR 15325 FX NB**

**EN**

485.9351.33/R.AA/10.01.2023/2-1

7721889256

**Dear Customer,**

**Please read this manual before using the product.**

Beko thank you for choosing the product. We want your product, manufactured with high quality and technology, to offer you the best efficiency. To do this, carefully read this manual and any other documentation provided before using the product and keep it as a reference. If you give the product to someone else, give the manual with it. Follow the instructions, taking into account all the information and warnings stated in the user manual.

Heed all information and warnings in the user manual. This way, you will protect yourself and your product against the dangers that may occur.

Keep the user manual. If you give the product to someone else, give the manual with it.

The user manual contains the following symbols:



Hazard that may result in death or injury.

**NOTICE** Hazard that may result in material damage to the product or its environment.



Hazard that may result in burns due to contact with hot surfaces.



Important information or useful usage tips.



Read the user manual.



**Arçelik A.Ş.**  
Karaağaç caddesi No:2-6  
34445 Söğütözü/İstanbul/TURKEY  
Made in TURKEY

## TABLE OF CONTENTS

### **1 Safety instructions 4**

Purpose of usage .....	4
Child, vulnerable person and pet safety .....	4
Electrical safety .....	5
Safety in gas operations .....	7
Transportation safety .....	8
Installation safety .....	9
Safety of use .....	10
Temperature warnings .....	11
Accessory use .....	11
Cooking safety .....	11
Maintenance and cleaning safety .....	12

### **2 Environmental Instructions 14**

Waste regulation .....	14
Compliance with the WEEE Directive and Disposing of the Waste Product .....	14
Package information .....	14
Recommendations for energy saving .....	14

### **3 Your product 15**

Product introduction .....	15
Product control panel introduction and usage .....	16
Oven control .....	16
Hob control .....	17
General information on hob .....	17
Product accessories .....	17
Use of product accessories .....	18
Technical specifications .....	21
Injector table .....	21

### **4 Installation 23**

Before installation .....	23
Electrical connection .....	26
Gas connection .....	26
Placing the product .....	29

### **5 First use 30**

First time setting .....	30
First cleaning .....	30

### **6 How to use the hob 31**

General information on hob usage .....	31
Operation of the hobs .....	31

### **7 How to operate the oven 33**

General information on oven usage .....	33
Turning on the gas oven .....	33
Turning on the gas grill .....	33
Using the timer .....	34
Rotisserie function .....	35

### **8 General information about cooking 37**

General warnings about cooking with hob	37
General warnings about cooking in the oven .....	37
Pastries and oven food .....	37
Meat, Fish and Poultry .....	39
Grill .....	40

### **9 Maintenance and care 41**

General cleaning information .....	41
Cleaning the accessories .....	42
Cleaning the hob .....	42
Cleaning the control panel .....	43
Cleaning the inside of the oven (cooking area) .....	43
Cleaning the oven door .....	43
Removing the inner glass of the oven door .....	45
Cleaning the oven lamp .....	45

### **10 Troubleshooting 47**

## **1 Safety instructions**

- This section contains safety instructions that will help prevent any risks of personal injuries or material damage.
- If the product is transferred to another person or used second hand, the operating manual, product labels, other relevant documents and accessories should be delivered with the product.
- Our company shall not be held responsible for any damage that may occur as a result of failure to comply with these instructions.
- Failure to comply with these instructions shall render any warranty void.
- **⚠** Always have the installation and repair work performed by the manufacturer, the authorized service or a person specified by the importer.
- **⚠** Use genuine spare parts and accessories only.
- **⚠** Do not attempt to repair or replace any part of the product unless it is clearly specified in the operating manual.
- **⚠** Do not perform technical modifications on the product.

### **⚠ Purpose of usage**

- This product is designed for home use. It is not suitable for commercial use.
- Do not use the product in gardens, balconies or other outdoor environments. The appliance is intended to be used in household and staff kitchen areas in shops, offices and other working environments.
- **WARNING:** This product should be used for cooking purposes only. It should not be used for different purposes, such as heating the room.
- The oven can be used to defrost, bake, fry and grill food.
- This product; should not be used for heating, plate heating, hanging towels or clothes on the handle for drying.

### **⚠ Child, vulnerable person and pet safety**

- This product can be used by children 8 years of age and older, and people who are underdeveloped in physical, sensory or mental skills, or

lack of experience and knowledge, as long as they are supervised or trained about the safe use and hazards of the product.

- Children should not play with the product. Cleaning and user maintenance should not be performed by children unless there is someone overseeing them.
- This product should not be used by people with limited physical, sensory or mental capacity (including children), unless they are kept under supervision or receive the necessary instructions.
- Children should be supervised to ensure that they do not play with the product.
- Electrical products and / or products with gas are dangerous for children and pets. Children and pets must not play with, climb on, or enter the product.
- Do not put objects that children may reach on the product.
- Turn the handle of the pots and pans to the side of the workbench so that children can not grab and burn.
- **WARNING:** During use, the accessible surfaces of the

product are hot. Keep children away from the product.

- Keep the packaging materials out of the reach of children. There is a hazard of injury and suffocation.
- If there are children in the environment when using the oven, you should use additional accessories that prevent direct contact with the oven door.
- When the door is open, do not put any heavy objects on it or allow children to sit on it. You may cause the oven to tip over or damage the door hinges.
- **(Not all products are supplied with a plug, so if your product DOES have a plug)** For the safety of children, disconnect the power plug and make the product inoperable before disposing of the product.



### **Electrical safety**

- Connect the product into a grounded outlet protected by a fuse that matches the current ratings indicated on the type label. Have the grounding installation made by a qualified electrician. Do not use the product without

grounding in accordance with local / national regulations.

- The plug or the electrical connection of the product should be in an easily accessible place (where it will not be affected by the flame of the stove). If this is not possible, there should be a mechanism (fuse, switch, switch, etc.) on the electrical installation to which the product is connected, in compliance with the electrical regulations and separating all poles from the network.
- The product must not be connected into the outlet during installation, repair, and transportation.
- Connect the product into an outlet that meets the voltage and frequency values specified on the type label.
- **(Not all products are supplied with a supply cord, so if your product DOES NOT have a supply cord)** Use only the connecting cable specified in the "Technical specifications" section.
- Do not jam the power cord under and behind the product. Do not put a heavy object on the power cord. The power cord should not be bent, crushed, and come into contact with any heat source.
- While the oven is operating, its back surface also gets hot. Gas connections and / or electrical cables should not touch the back surface, connections may be damaged.
- Do not jam the electric cables into the oven door and pass them over hot surfaces. You may cause the oven to short circuit and catch fire as a result of the cable melting.
- Use original cable only. Do not use cut or damaged cables or extension leads.
- If the power cord is damaged, it must be replaced by a manufacturer, an authorized service or a person to be specified by the importer company in order to prevent possible dangers.
- **WARNING:** Before replacing the oven lamp, be sure to disconnect the product from the mains supply to avoid the risk of electric shock. Switch off the product or turn off the fuse from the fuse box.

**(Not all products are supplied with a plug, so if your product DOES have a plug)**

- Do not plug the product into an outlet that is loose, has come out of its socket, is broken, dirty, oily, with risk of water contact (for example, water that may leak from the counter).
- Never touch the plug with wet hands! To unplug, do not hold the cord, always hold the plug.
- Make sure that the product plug is securely plugged into the outlet to avoid arcing.



**Safety in gas operations**

- **WARNING:** The use of gas cooker products causes the formation of substances released as a result of heat, humidity and combustion in the room. Make sure that the kitchen is well ventilated, especially when using the product: Keep the natural ventilation holes open or install a mechanical ventilation device (mechanical extractor / hood). Intensive use of the product for a long time may require additional ventilation: For example, opening a

window or more effective ventilation, raising the level of the mechanical ventilation device, if any, etc.

- This product should be used in a room that has a properly adjusted and functioning carbon monoxide sensor. Make sure that the carbon monoxide sensor is working properly and frequently service the sensor. The carbon monoxide sensor should be placed no more than 2 meters from the product.
- It is required for gas to burn well in products with gas. If the gas does not burn adequately, carbon monoxide (CO) may be released. Carbon monoxide is a colorless, odorless and very toxic gas, and even a small amount has a fatal effect. You can understand that the gas is burning well if the flames are continuous and blue. If the flames are wavy, cut and intensely yellow, the gas does not burn well.
- Gas products and gas systems should be checked regularly for proper operation. The hose hood, hose and clamp should be checked

regularly and renewed in periods recommended by the manufacturer and when necessary.

- Always use LPG cylinders in an upright position. If it is not used in an upright position, Propane / Butane in liquid form may enter the product and cause gas leaks and sudden flares.
- Clean the gas hotplates regularly. Make sure that the gas burns properly after cleaning.
- Do not use pots / pans that exceed the dimensions given in the user manual. Using larger pans / pots than specified may cause carbon monoxide poisoning and overheating of nearby surfaces and control buttons. The use of smaller pans / pots may cause you to burn due to flames.
- Ask your local gas supplier for phone numbers for gas-related emergencies and information about measures to be taken in case of gas smell.
- Conditions and values for gas adjustment of this product are provided on the rating/type label.

## **What to do when you smell gas!**

- Do not use naked flames and do not smoke. Do not use any electrical buttons (eg lamp button or doorbell). Do not use a landline or mobile phone.
- Open the doors and windows.
- Close all valves on gas products and gas meters.
- Check if all pipes and connections are leaking. If you still smell gas, leave the house.
- Warn neighbors.
- Call the fire department. Use a phone outside the house.
- Call the authorized service and your gas distribution company.
- Do not enter the house until it is reported to be safe by authorized persons.

## **Transportation safety**

- Before transporting the product, disconnect the product from the mains and disconnect the gas connections.
- The product is heavy, carry the product with at least two people.



- Do not use the door and / or handle to transport or move the product.
- Make sure that the power cable is not jammed while putting the product to its place after assembly or cleaning.
- Do not put other items on the product and carry the product upright.
- When you need to transport the product, wrap it with bubble wrap packaging material or thick cardboard and tape it tightly. Secure the product tightly with tape to prevent the removable or moving parts of the product and the product from damage.
- Check the overall appearance of the product for any damage that may have occurred during transportation.



### **Installation safety**

- Before the product is installed, check the product for any damage. If the product is damaged, do not install it.
- Do not place the product on carpeted floors. Its electrical parts overheat as it cannot receive air from the bottom.

This causes the product to malfunction.

- The product should be placed directly on a clean, flat and hard surface. It should not be placed on a plinth or bedplate.
- Do not install the product near heat sources (radiators, stoves, etc.).
- Keep all ventilation ducts open around the product.
- Do not install the product under a window. When you open the window, hot cookware may tip over. There is also a risk of curtains catching fire.
- To prevent overheating, the product should not be installed behind decorative doors.

### **For products with gas:**

- Before installation, check whether the local distribution (gas type and gas pressure) conditions are compatible with the product settings.
- Any work on gas equipment and systems should be carried out by authorized and qualified persons.
- Please cut off the gas supply before starting any work on gas installation. There is an explosion hazard.

- The connection of the product to the gas distribution system can only be made by an authorized and qualified person. There is an explosion or poisoning hazard due to repairs by non-professional people.
- The flexible gas hose must be connected in such a way that it does not touch the moving parts in the area where it is placed and does not get caught when the moving parts move (eg drawer). In addition, the gas hose should not be placed in spaces where there is a possibility of jamming.
- The gas hose must not be crushed, folded, jammed or touch hot parts of the product and cookware on the product. There is an explosion hazard due to damage to the gas hose.
- Make sure to check for gas leakage after the gas connection of your product is made. Make sure there are no gas leaks. Do not use the product if there is a gas leak.
- There is no element in the product that discharges the gases produced by combustion. The product must be installed and

connected in accordance with applicable installation regulations. Particular attention should be paid to ventilation requirements. See the room ventilation section described in the manual.

### **Safety of use**

- Make sure that the product is turned off after each use.
- If you do not use the product for a long time, disconnect it or turn off the fuse from the fuse box.
- If you do not use the product for a long time, turn off the main gas tap.
- Do not operate defective or damaged product. If any, disconnect the electricity / gas connections of the product and call the authorized service.
- Do not use the product with the front door glass removed or broken.
- Do not climb on the product to reach anything or for any other reason.
- Do not use the product in situations that may affect your judgment, such as drug intake and / or alcohol use.
- Flammable objects kept in the cooking area may catch

fire. Never store flammable objects in the cooking area.

- The oven handle is not a towel dryer. When using the product, do not hang towels, gloves or similar textiles.
- The hinges of the product door move and tighten when opening and closing the door. When opening / closing the door, do not hold the part with the hinges.
- Do not close the top door before the cookers have cooled down.
- Wipe before opening the top door to prevent liquid from entering or behind the oven.
- This product is not suitable for use with a remote control or an external clock.

### **Temperature warnings**

- **WARNING:** While the product is operating, exposed parts will be hot. Do not touch the product and heating elements. Children under the age of 8 should not be brought close to the product without an adult.
- Do not place flammable / explosive materials near the product, as the edges will be hot while it is operating.
- As steam may be exhaled, keep away while opening the

oven door. The steam may burn your hand, face and / or eyes.

- The product may be hot during use. Do not touch the hot compartments, the interior parts of the oven, the heating elements, etc.
- When placing food in the hot oven, removing the food, etc. always use heat resistant oven gloves.
- **WARNING:** Danger of fire: Do not store items on the cooking surfaces.

### **Accessory use**

- It is important that the wire grill and tray are placed properly on the wire shelves. For detailed information, refer to the section "Usage of accessories".
- Accessories can damage the door glass when closing the product door. Always push the accessories to the end of the cooking area.

### **Cooking safety**

- **WARNING:** The cooking process must be observed. Short-term cooking processes must be constantly observed.
- **WARNING:** Unattended cooking on a hob with fat or

oil can be dangerous and may result in fire. NEVER try to extinguish a fire with water, but switch off the appliance and then cover flame e.g. with a lid or a fire blanket.

- Be careful when using alcohol in your food. Alcohol evaporates at high temperatures and may catch fire when exposed to hot surfaces, causing a fire.
- Food waste, oil, etc. in the cooking area may catch fire. Before cooking, remove such coarse dirt.
- Food Poisoning Hazard: Do not keep food in the oven for more than an hour before and after cooking. Otherwise it may cause food poisoning or diseases.
- Do not heat closed tin cans and glass jars. Built up pressure may cause the jar to burst.
- Place the greaseproof paper in a cookware or on the oven accessory (tray, wire grill, etc.) with food and place it in the preheated oven. Remove any excessive pieces of greaseproof paper hanging from the accessory or container to avoid the risk of touching the oven heating elements. Never use greaseproof paper at an oven temperature higher than the maximum use temperature specified on the greaseproof paper you are using. Never place greaseproof paper on the oven base.
- Do not place baking trays, plates or aluminum foil directly on the bottom of the oven. The accumulated heat can damage the base of the oven.
- Close the oven door during grilling. Hot surfaces may cause burns!
- Food not suitable for grilling carries a fire hazard. Grill only food that is suitable for heavy grill fire. Also, do not place the food too far in the back of the grill. This is the hottest area and fatty foods may catch fire.
- Place the cookware in the center of the burners. Note that the fire in the burner with the cookware does not overflow to the side of the cookware.



### **Maintenance and cleaning safety**

- Wait for the product to cool before cleaning the product.

Hot surfaces may cause burns!

- Never wash the product by spraying or pouring water on it! There is an electric shock hazard!
- Do not clean the product with steam cleaners as this may cause electric shock.
- Do not use harsh abrasive cleaners, metal scrapers, wire wool or bleach

materials to clean the oven front door glass / (if present) oven upper door glass.

These materials can cause glass surfaces to be scratched and broken.

- Always keep the control panel clean and dry. A damp and dirty surface may cause problems in operating the functions.

## 2 Environmental Instructions

### Waste regulation

#### Compliance with the WEEE Directive and Disposing of the Waste Product



This product complies with EU WEEE Directive (2012/19/EU).

This product bears a classification symbol for waste electrical and electronic equipment (WEEE).

This product has been manufactured with high quality parts and materials which can be reused and are suitable for recycling. Do not dispose of the waste product with normal domestic and other wastes at the end of its service life. Take it to the collection center for the recycling of electrical and electronic equipment. Please consult your local authorities to learn about these collection centers.

Appropriate disposal of used appliance helps prevent potential negative consequences for the environment and human health.

#### Compliance with RoHS Directive:

The product you have purchased complies with EU RoHS Directive (2011/65/EU). It does not contain harmful and prohibited materials specified in the Directive.

#### Package information

- Packaging materials of the product are manufactured from recyclable materials in accordance with our National Environment Regulations. Do not dispose of the packaging materials together with the domestic or other wastes. Take them

to the packaging material collection points designated by the local authorities.

### Recommendations for energy saving

Information on energy efficiency according to EU 66/2014 can be found on the product fiche given with the product. The following suggestions will help you use your product in an ecological and energy-efficient way:

- Defrost frozen food before cooking.
- In the oven, use dark or enamelled containers that transmit heat better.
- Turn off the product 5 to 10 minutes before the end time of cooking for prolonged cooking. Now you can save up to 20% electricity by using heat.
- If specified in the recipe or user manual, always preheat. Do not open the oven door frequently during cooking.
- Try to cook more than one dish at a time in the oven. You can cook at the same time by placing two cooking containers on the wire shelf. In addition, if you cook your meals one after the other, it will save energy because the oven will not lose its heat.
- Use pots / pans with a size and lid suitable for the hotplate. Always choose the right size pot for your meals. More than necessary energy is needed for containers of the wrong size.
- Keep hob cooking surfaces and pot bases clean. Dirt reduces the heat transfer between the cooking area and the pot base.

## 3 Your product

### Product introduction

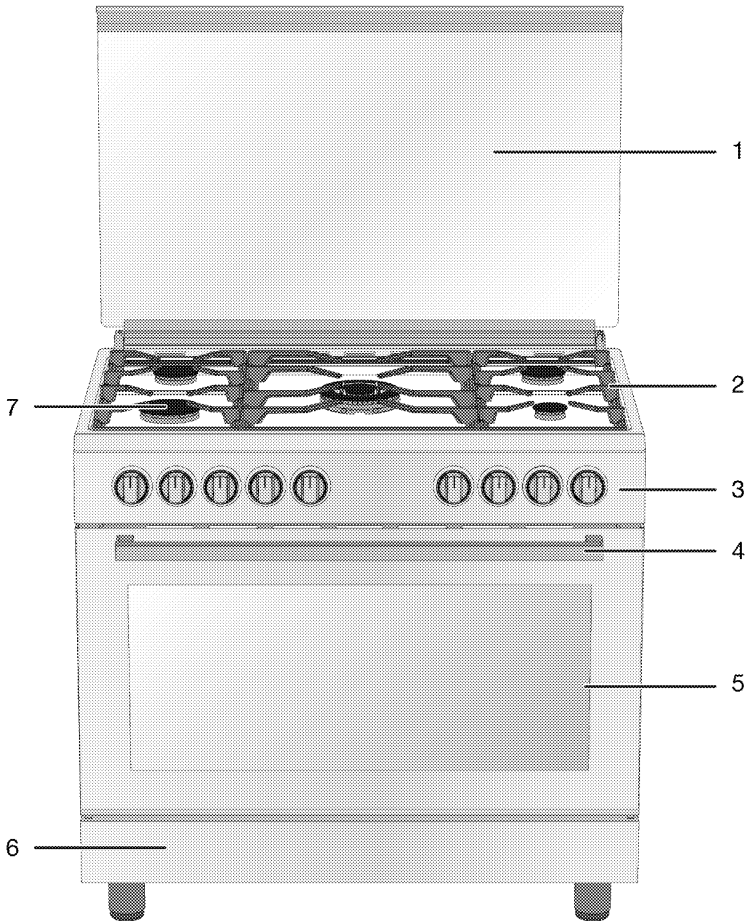

- 1 Top glass lid
- 2 Pan support
- 3 Control panel
- 4 Handle
- 5 Door
- 6 Lower part
- 7 Hob burners

## Product control panel introduction and usage

In this section, you can find the overview and basic uses of the product's control panel. There may be differences in images and some features depending on the type of product.

### Oven control

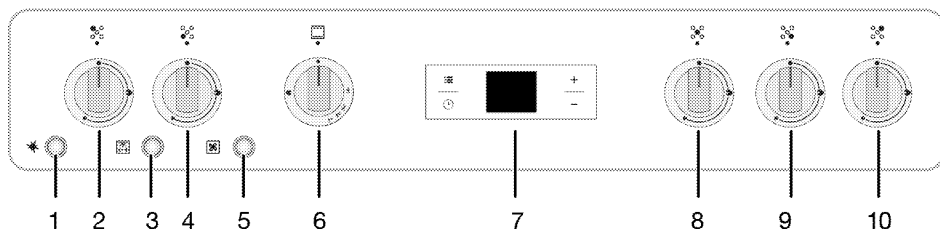

- 1 Ignition button
- 2 Rear left - hob control knob
- 3 Lamp/Rotisserie button
- 4 Front left - hob control knob
- 5 Fan button
- 6 Oven control knob
- 7 Timer
- 8 Middle - hob control knob
- 9 Front right - hob control knob
- 10 Rear right - hob control knob

### Oven control knob

You can control your oven with oven control button. No gas is supplied to the oven in the closed position (top). After igniting your oven burner, you can cook by adjusting the gas levels on the button.

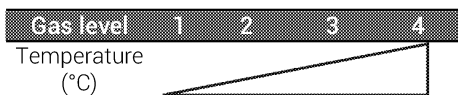

### Fan button

You may turn the fan of your oven on and off with the fan button. The heat inside the oven while cooking is distributed equally and rapidly throughout the oven with the fan. You may achieve a more homogeneous cooking in this way.

### Furnace temperature

### Timer

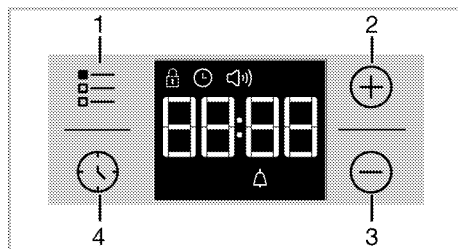

- 1 Settings key
- 2 Increase key
- 3 Decrease key
- 4 Time setting key (The symbol may vary depending on your product. 🕒 / 🔔)

### Display symbols

- 🔔 : Alarm symbol
- 🔊 : Volume symbol
- 🔒 : Key lock symbol
- 🕒 : Time symbol

### Ignition button

It is used for igniting your oven. In case of power failure, the ignition button will not operate.

### Lamp/Rotisserie button

You may turn on the lamp and the rotisserie function of your oven on and off with the lamp/rotisserie button. In case of power outage, the rotisserie motor and the oven lamp will not operate. The operation of the rotisserie function is described in the following sections.



## Hob control

### Gas burner control knob

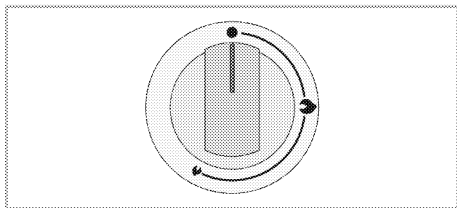

You can operate your hob with the hob control knobs. Each knob operates the respective burner. You may infer which burner it controls from the symbols on the control panel. When turned off (top position), the burner is not fuelled with gas. After igniting the burner, you can cook by setting the gas levels on the knob. Set your desired cooking power by aligning the knob to the respective symbol.

Indicator	Specifications
●	Off position
🔥	Small flame: Lowest gas power

Indicator	Specifications
🔥	Large flame: Highest gas power

### General information on hob

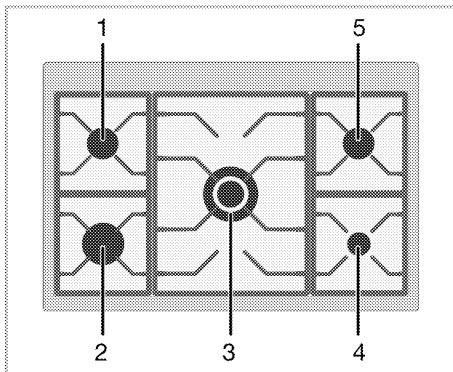

- 1 Rear left - Normal burner
- 2 Front left - Rapid burner
- 3 Middle - Wok burner
- 4 Front right - Auxiliary burner
- 5 Rear right - Normal burner

## Product accessories

There are various accessories in your product. In this section, the description of the accessories and the descriptions of the correct usage are available. Depending on the product model, the supplied accessory varies. All accessories described in the user guide may not be available in your product.

**NOTICE** : The trays in your product may be deformed by the effect of the temperature. This has no effect on the function. Deformation disappears when the tray cools down.

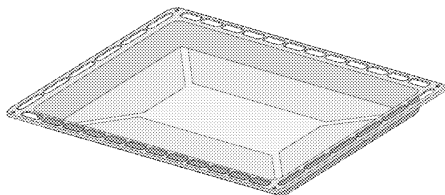

### Standard tray

It is used for pastries, frozen foods and frying large pieces.

### Models with wire shelves:

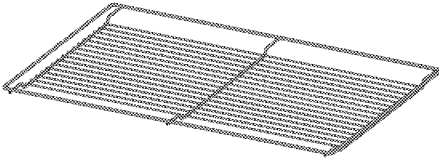

### Models without wire shelves:

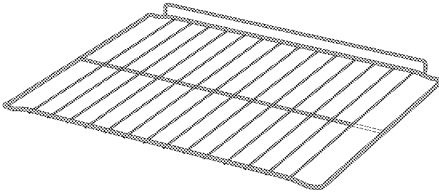

### Wire grill

It is used for frying or placing the food to be baked, fried and stewed on the desired shelf.

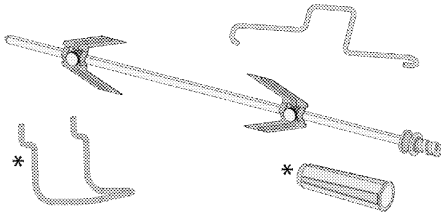

### Rotisserie and skewer

It is used for grilling red meat, poultry and fish from all directions.

\*Plastic handle and rotisserie/skewer support wire are provided depending on the model. They may not be available on your product.

## Use of product accessories

### Cooking shelves

There are 5 levels of shelf position in the cooking area. You can also see the order of the shelves in the numbers on the front frame of the oven.

### Models with wire shelves

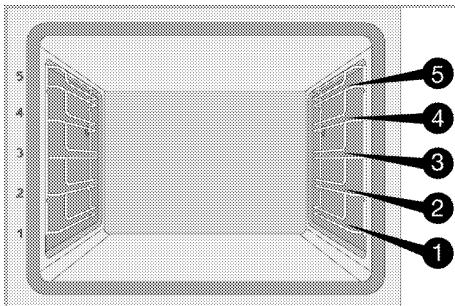

### Models without wire shelves

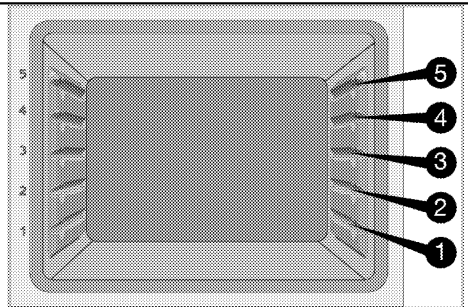

### Placing the wire grill on the cooking shelves

### Models with wire shelves:

It is crucial to place the wire grill on the wire side shelves properly. The wire grill should be placed between two wire racks as shown in the figure.

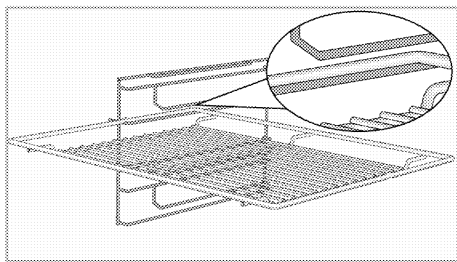

#### Models without wire shelves:

It is crucial to place the wire grill on the side shelves properly. The wire grill has one direction when placing it on the shelf. While placing the wire grill on the desired shelf, the open section must be on the front.

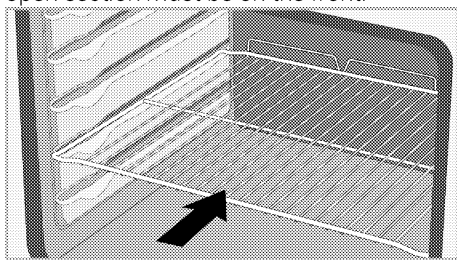

#### Placing the tray on the cooking shelves

##### Models with wire shelves:

It is also crucial to place the trays on the wire side shelves properly. For better cooking, the tray must be secured with the stopper on the wire shelf. It must not pass over the stopper to contact with the rear wall of the oven.

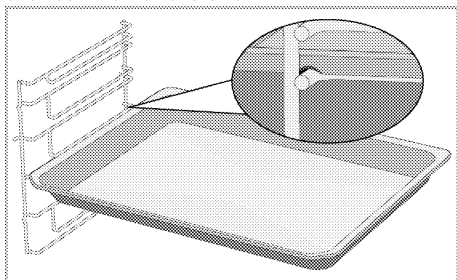

#### Stopper function of the wire grill

There is a stopper function to prevent the wire grill from tipping out of the wire shelf. With this function, you can easily and safely take out your food. While removing the wire grill, you can pull it forward until it reaches

the stopper. You must pass over the stopper to remove it completely.

#### Models with wire shelves

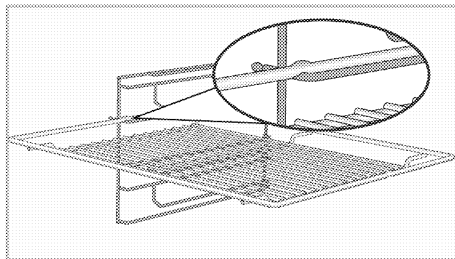

#### Models without wire shelves

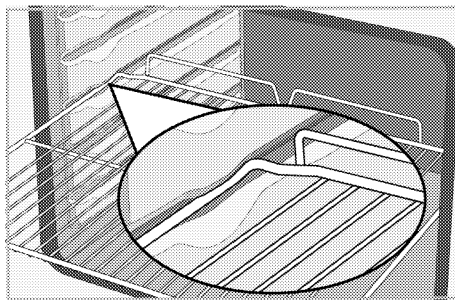

#### Stopper function of the wire grill tray - Models with wire shelves

There is also a stopper function to prevent the tray from tipping out of the wire shelf. While removing the tray, release it from the rear lock and pull it towards yourself until it reaches the stopper. You must pass over the stopper to remove it completely.

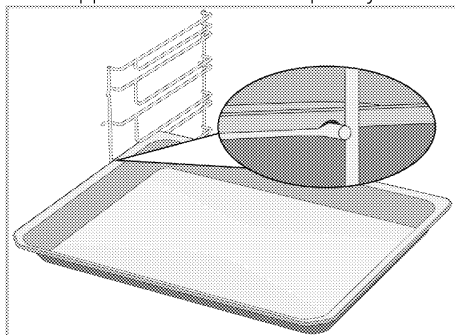

#### Proper placement of the wire grill and tray on the telescopic rails-Models with wire shelves and telescopic rails

Thanks to telescopic rails, trays or the wire grill can be easily installed and removed. When using trays and wire grills with the

telescopic rail, care should be taken that the pins, on the front and back of the telescopic rails, rest against the edges of the grill and the tray (shown in the figure).

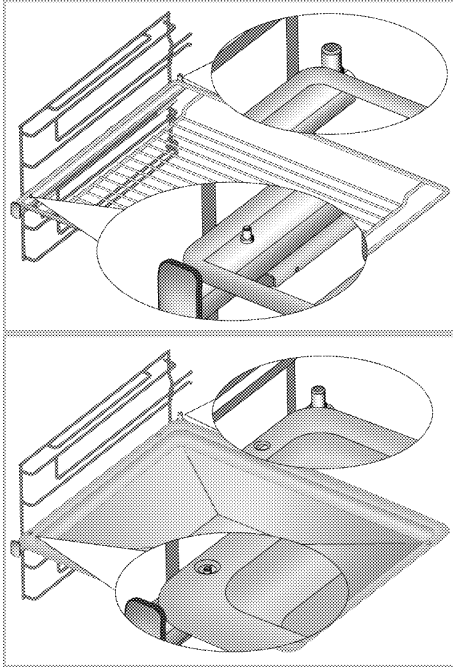

### Attaching the rotisserie spit

As shown in the figure, attach the rotisserie spit's hook to the hook slot.

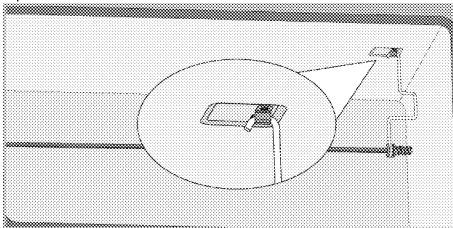

As shown in the figure, attach the rotisserie and skewer support wire into its place.  
\*Rotisserie and skewer support wire and its place on the product, provided depending on the model. They may not be available on your product.

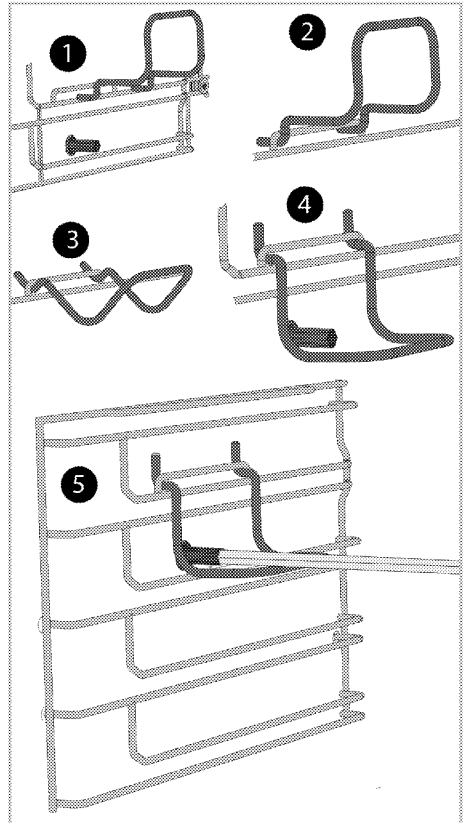

Place the pointed edge of the spit into the rotating slot on the left side inside the oven. If your spit has a plastic handle, remove it. As shown in the figure, hang the other edge of the spit onto the hook. Make sure the spit is secured with the hook, as in the figure.

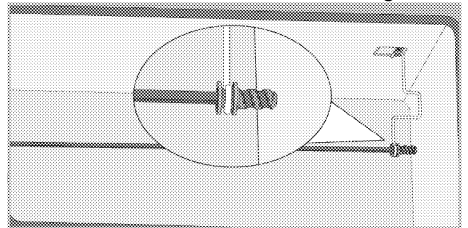

## Technical specifications

### General specifications

Product external dimensions (height/width/depth)	830 mm /900 mm/600 mm
Voltage / frequency	220-240 V ~ 50 Hz
Cable type and cross section used / suitable for use in the product	min. H05VV-FG 3 x 0,75 mm <sup>2</sup>
Total gas consumption	15 kW
Gas type / pressure that the product is set	LPG G 30/28-30 mbar
Gas types / pressures to which the product can be converted	NG G 20/20 mbar/

### Burners

Rear left	<b>Normal burner</b>
Power	2 kW
Front left	<b>Rapid burner</b>
Power	2,9 kW
Middle	<b>Wok burner</b>
Power	3,6 kW
Front right	<b>Auxiliary burner</b>
Power	1 kW
Rear right	<b>Normal burner</b>
Power	2 kW

### Oven

Oven type	Gas oven
Oven gas consumption	3,5 kW
Grill gas consumption	2,8 kW



Technical specifications may be changed without prior notice to improve the quality of the product.



Figures in this manual are schematic and may not exactly match your product.



Values stated on the product labels or in the documentation accompanying it are obtained in laboratory conditions in accordance with relevant standards. Depending on operational and environmental conditions of the product, these values may vary.

### Injector table

Position hob zone	2 kW		2,9 kW	3,6 kW	1 kW	2 kW	
	Rear left	Front left	Middle	Front right	Rear right		
Gas type / Gas pressure							
G 20/20 mbar	103	115	147	72	103		
G 30/28-30 mbar	72	87	96	50	72		
Gas type / Gas pressure	Gas oven			Gas grill			
G 20/20 mbar	132			122			
G 30/28-30 mbar	92			84			

You can obtain the injectors which were not provided with your product, from the authorised service provider.

## Country gas categories/types/pressure

You can find the gas type, pressure and gas category that can be used for the country where the product will be installed in the table below.

COUNTRY CODES	CATEGORY		GAS TYPE AND PRESSURE			
			G20,20 mbar	G25,25 mbar	G30,28 30 mbar	G31,37 mbar
FR	Cat II	2E+3+	G20,20 mbar	G25,25 mbar	G30,28 30 mbar	G31,37 mbar
BE	Cat II	2E+3+	G20,20 mbar	G25,25 mbar	G30,28 30 mbar	G31,37 mbar
RU	Cat II	2H3B/P	G20,20 mbar	G30,30 mbar	G20,13 mbar	G20,10 mbar
CZ	Cat II	2H3+	G20,20 mbar	G30,28 30 mbar	G31,37 mbar	
NL	Cat II	2E(43.46 - 45.3 MJ/m <sup>3</sup> (0°C))3B/P	G25.3,25 mbar	G20,20 mbar	G30,30 mbar	
	Cat II	2L3B/P	G25,25 mbar	G20,20 mbar	G30,30 mbar	
GB	Cat II	2H3+	G20,20 mbar	G30,28 30 mbar	G31,37 mbar	
IE	Cat II	2H3+	G20,20 mbar	G30,28 30 mbar	G31,37 mbar	
ES	Cat II	2H3+	G20,20 mbar	G30,28 30 mbar	G31,37 mbar	
PT	Cat II	2H3+	G20,20 mbar	G30,28 30 mbar	G31,37 mbar	
CH	Cat II	2H3+	G20,20 mbar	G30,28 30 mbar	G31,37 mbar	
IT	Cat II	2H3+	G20,20 mbar	G30,28 30 mbar	G31,37 mbar	
SK	Cat II	2H3+	G20,20 mbar	G30,28 30 mbar	G31,37 mbar	
CY	Cat II	2H3+	G20,20 mbar	G30,28 30 mbar	G31,37 mbar	
SI	Cat II	2H3+	G20,20 mbar	G30,28 30 mbar	G31,37 mbar	
GR	Cat II	2H3+	G20,20 mbar	G30,28 30 mbar	G31,37 mbar	
PL	Cat II	2ELS3B/P	G20,20 mbar	G2.350,13 mbar	G30,37 mbar	
	Cat II	2E3P(B/P)	G20,20 mbar	G30,37 mbar		
DE	Cat II	2E3B/P	G20,20 mbar	G30,50 mbar		
AT	Cat II	2H3B/P	G20,20 mbar	G30,50 mbar		
SE	Cat II	2H3B/P	G20,20 mbar	G30,30 mbar		
LT	Cat II	2H3B/P	G20,20 mbar	G30,30 mbar		
NO	Cat II	2H3B/P	G20,20 mbar	G30,30 mbar		
RO	Cat II	2H3B/P	G20,20 mbar	G30,30 mbar		
DK	Cat II	2H3B/P	G20,20 mbar	G30,30 mbar		
EE	Cat II	2H3B/P	G20,20 mbar	G30,30 mbar		
MA	Cat II	2H3B/P	G20,20 mbar	G30,30 mbar		
FI	Cat II	2H3B/P	G20,20 mbar	G30,30 mbar		
HR	Cat II	2H3B/P	G20,20 mbar	G30,30 mbar		
TR	Cat II	2H3B/P	G20,20 mbar	G30,30 mbar		
MT	Cat I	3B/P	G30,30 mbar			
IS	Cat I	2H	G20,20 mbar			
LV	Cat I	2H	G20,20 mbar			
LU	Cat I	2E	G20,20 mbar			
BG	Cat I	2H	G20,20 mbar			
	Cat I	3B/P	G30,30 mbar			
HU	Cat I	2H	G20,25 mbar			
	Cat I	3B/P	G30,30 mbar			

## 4 Installation

### General warnings

- Product must be installed by a qualified person in accordance with the regulations in force. The manufacturer shall not be held responsible for damages arising from procedures carried out by unauthorized persons which may also void the warranty.
- It is customer's responsibility to prepare the location the product shall be placed on and also have power and/or gas utility prepared. The rules specified in local standards about electrical and/or gas installations (legal rules on installation) shall be followed during product installation.
- Check for any damage on the appliance before the installation. Do not have it installed if the appliance is damaged. Damaged products cause risks for your safety.

### Before installation

#### Right place for installation

- Any kitchen furniture next to the appliance must be heat-resistant (100 °C min.).
- Place the product on a hard surface because of the air ducts under the product. It must not be placed onto a base or a pedestal. The feet of the product should not dip on soft surfaces, e.g. carpet, etc.
- The kitchen floor must be able to carry the weight of the appliance plus the additional weight of cookware and bakeware and food.
- Do not install the product near refrigerators or coolers. The heat emitted by the product increases the energy consumption of the cooling units.
- While using LPG (liquid petroleum gas): Do not install the product under the floor level. Do not use the product if it is not installed so that a surface at least at one side of it is level with the room floor. Improper installation of the product may cause dangerous consequences.
- This product is a class 1 device according to EN 30-1-1 standard. It can be placed adjacent to the kitchen walls, kitchen furniture or any other product in any

dimension from behind and **one** edge. The kitchen furniture or equipment on the **other** side may only be of the same size or smaller.

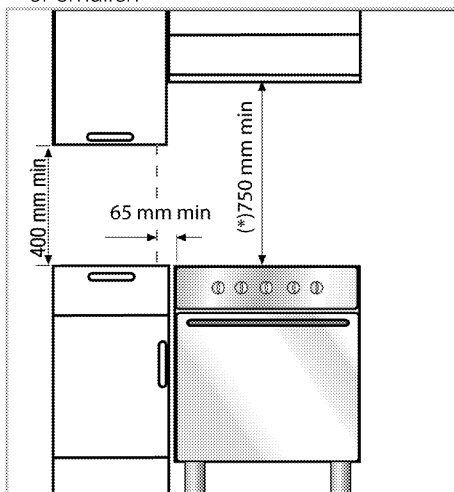

- It can be used with cabinets on either side but in order to have a minimum distance of 400mm above hotplate level allow a side clearance of 65mm between the appliance and any wall, partition or tall cupboard.
- It can also be used in a free standing position. Allow a minimum distance of 750 mm above the hob surface.
- (\*) If a cooker hood is to be installed above the cooker, refer to the instructions of the manufacturer of the cooker hood regarding installation height (min. 650 mm).

#### Room ventilation

All rooms require an openable window, or equivalent, and some rooms will require a permanent vent as well. The air for combustion is taken from the room air and the exhaust gases are emitted directly into the room. Good ventilation is essential for safe operation of your appliance.

#### Rooms with doors and/or windows which open directly to the outer environment

The doors and/or windows that open directly to the outer environment must have a total ventilation opening of the dimensions

specified in the table below which is based on the total gas power of the appliance (total gas power consumption of the appliance is shown in the technical specification table of this user manual). If the doors and/or windows do not have a total ventilation opening corresponding to the total gas consumption of the appliance as specified in the table below, then there must definitely be an additional fixed ventilation opening in the room to ensure that the total minimum ventilation requirements for the total gas consumption of the appliance is achieved. The fixed ventilation opening can include openings for existing airbricks, extraction hood ducting opening dimension etc.

Total gas consumption (kW)	Min. ventilation opening (cm <sup>2</sup> )
0-2	100
2-3	120
3-4	175
4-6	300
6-8	400
8-10	500
10-11.5	600
11.5-13	700
13-15.5	800
15.5-17	900
17-19	1000
19-24	1250

### Rooms that do not have openable doors and/or windows that open directly to the outer environment

If the room where the appliance is installed does not have a door and/or a window that opens directly to the external environment, other products shall be sought that definitely provide a fixed non-adjustable and non-closable ventilation opening which meets the total minimum ventilation opening requirements for the total gas consumption of the appliance as indicated in the above table. Also the appropriate building regulations advise should be followed.

Where a room or internal space contains more than one gas appliance, additional

ventilation area shall be provided on top of the requirement given in the table above. Size of additional ventilation area shall be appropriate to regulations of other gas appliances.

There should also be a minimum clearance of 10mm on the bottom edge of the door that opens to the inner environment in the room where the appliance is installed. You must ensure that items such as carpets and other floor coverings etc., do not affect the clearance when the door is closed.

The cooker may be located in a kitchen, kitchen/diner or a bed-sitting room, but not in a room containing a bath or a shower.

The cooker must not be installed in a bed-sitting room of less than 20 m<sup>3</sup>.

Do not install this appliance in a room below ground level unless it is open to ground level on at least one side.

### Fixing the oven feet

1. 4 feet are supplied together with your oven. Each foot must be installed into respective slots located at 4 corners under the oven.
2. Screw the thread of the foot by turning in clockwise.
3. For your safety, make sure that they are level when screwing all 4 feet. Unbalance of the legs has negative influence on cooking.

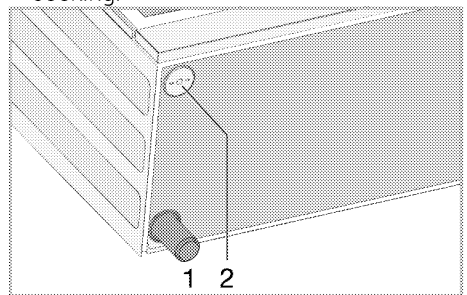

- 1 Foot
- 2 Foot slot

### Safety chain

The appliance must be secured against overbalancing by using the supplied one safety chain on your oven.

- **If your product has 2 safety chains;**



Fasten hook (1) by using a proper peg to the kitchen wall (6) and connect safety chain (3) to the hook via the locking mechanism (2)

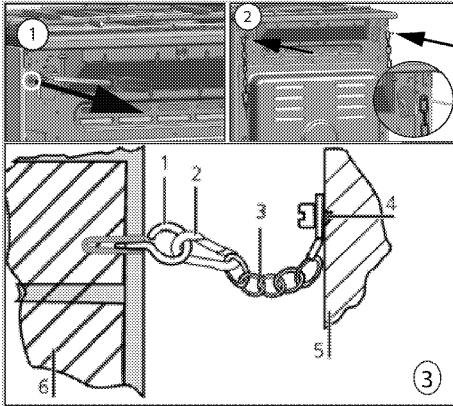

- 1 Hook
- 2 Locking mechanism
- 3 Safety chain
- 4 Firmly fix chain to cooker rear
- 5 Rear of cooker
- 6 Kitchen wall

- **If your product has 1 safety chains;** Follow below steps in the picture to secure the safety chain to your product.

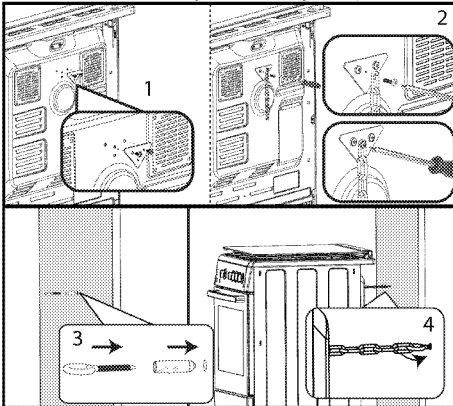

- i** Stability chain to be as short as practicable to avoid oven tilting forward and diagonal to avoid oven side tilting. Stability chain is designed for cookers without a bracket engagement slot.

## Transportation of the Product

- Carry the appliance with at least two persons.
- Do not use the door and/or handle to transport or move the product. The door, handle or hinges may be damaged.
- Movement of your appliance is most easily achieved by lifting the front as follows and pulling towards.
- Movement of your appliance is most easily achieved by lifting the front as indicated in the drawing. While gripping, it should be avoided to damage any grill elements or oven interior furniture.

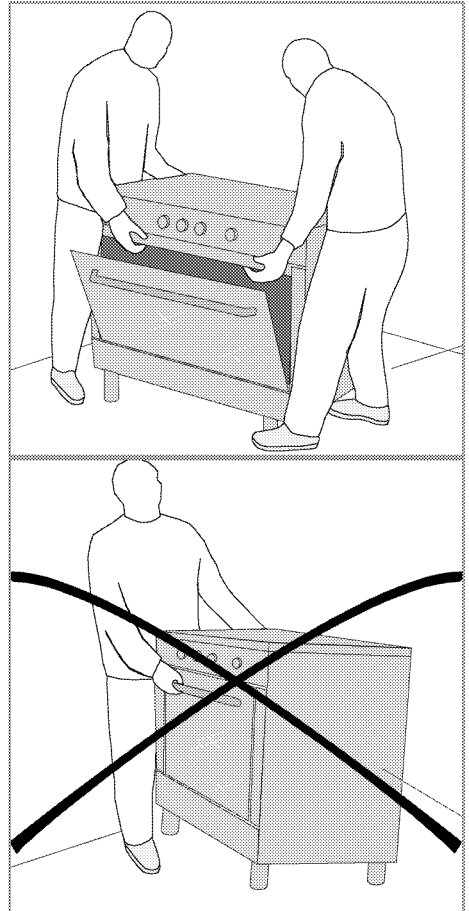

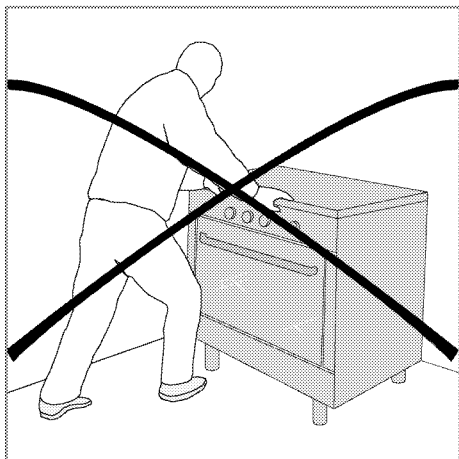

## Electrical connection

### General warnings

- Electrical connection shall comply with national regulations.
- Disconnect the product from the electric connection before starting any work on the electrical installation. There is an electric shock hazard.
- Connect the product to a grounded outlet/line protected by a miniature circuit breaker of suitable capacity as stated in the "Technical specifications" table. Have the grounding installation made by a qualified electrician while using the product with or without a transformer. Our company shall not be liable for any damages that will arise due to using the product without a grounding installation in accordance with the local regulations.
- The product can only be connected to the mains electricity connection by an authorized and qualified person, and the warranty of the product starts only after correct installation. The manufacturer cannot be held responsible for any damages that may arise due to operations by unauthorized persons.
- The electric cable must not be crushed, folded, jammed or touch hot parts of the product. If the electric cable is damaged, it must be replaced by a qualified electrician. Otherwise there is an electric shock, short circuit or fire hazard!
- The mains supply data must correspond to the data specified on the type label of

the product. The rating plate is either seen when the door or the lower cover of the appliance is opened or it is located at the rear wall of the appliance depending on the appliance type.

- The mains supply data must correspond to the data specified on the type label of the product. Type label is at the rear housing of the product.
- Power cable of your product must comply with the values in "Technical specifications" table.
- Power cable plug must be within easy reach after installation (do not route it above the hob).
- Do not use extension or multi sockets in power connection.
- While performing the wiring, you must apply with the national/local electrical regulations and must use the appropriate socket outlet/line and plug for oven. In case of the product's power limits are out of current carrying capability of plug and socket outlet/line, the product must be connected through fixed electrical installation directly without using plug and socket outlet/line.

### If your appliance has a cord and plug:

- Perform the electrical connection of your appliance by plugging it to a grounded socket.

### For the protection of the appliance against burning:

1. Make sure that the product plug is securely plugged into the outlet to avoid arcing.
2. Do not use damaged cables or extension cables.
3. Ensure liquid or moisture is not accessible to the electrical connection point.

## Gas connection

### General warnings

- The connection of the product to the gas distribution system can only be made by an authorized and qualified person. There is an explosion or poisoning hazard due to repairs by non-professional people. The manufacturer cannot be held responsible for any damages that may arise due to operations by unauthorized persons.

- Please cut off the gas supply before starting any work on gas installation. There is an explosion hazard!
- Gas setting conditions and values are stated on labels (or on the type label).
- Your gas connection or gas conversion may be different as per your country. Explanations for different gas connections or conversions may be provided as an additional manual together with the appliance, and these manuals indicate the country they are applicable for. Perform the gas connection or gas conversion as per the descriptions specified in the additional manual intended for your country.
- If at a later time you have to use your product with a gas type different than the one it is set for, you shall contact the authorized service for the conversion.
- Procure the plastic gas hose and installation clamp before making the gas connection. Inner diameter of the plastic gas hose must be max. 10 mm and its length must be max. 125 cm.

**i** Your product is equipped for liquefied petroleum gas (LPG).

### Connecting the gas hose

- Have your product connected in a way that it will be close to the LPG cylinder and that it shall not leak any gas.
- Fit the installation clamp onto one end of the hose. Soak the hose end fitted with clamp into boiling water for one minute to soften it.
- Slip the softened end of the hose completely onto the sharp hose tip of your product. Finally, tighten the clamp completely with a screwdriver.
- Repeat the same procedure for the other end of the hose and complete the gas regulator connection.
- Never forget to make the gas leakage control.

**!** Risk of explosion and suffocation!  
Do not keep LPG cylinders in home.

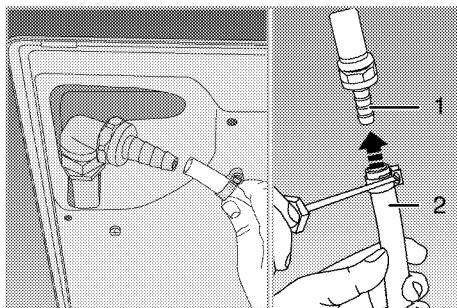

- 1 LPG hose tip
- 2 Plastic hose

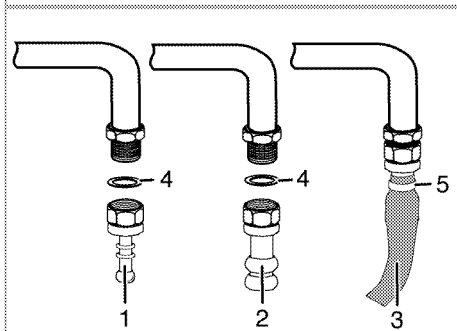
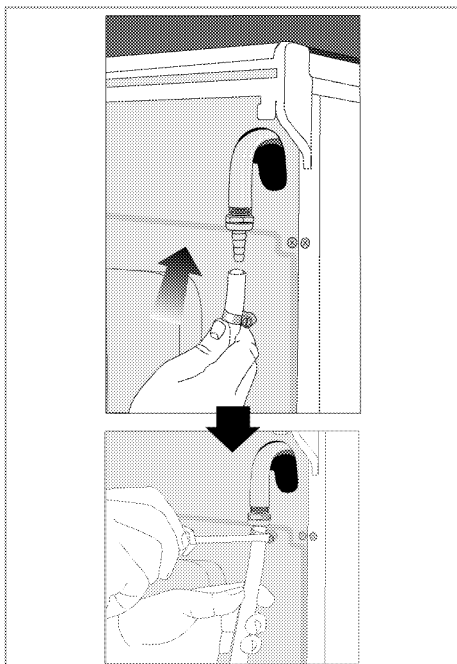

- 1 Hose tip-LPG

- 2 Hose tip-NG
- 3 Safety hose
- 4 O-ring (gasket)
- 5 Clamp

**If your product has only one gas outlet;**

- Before connecting the gas hose, make sure that the gas hose outlet at the back of the product is on the same side of the product as the LPG cylinder.

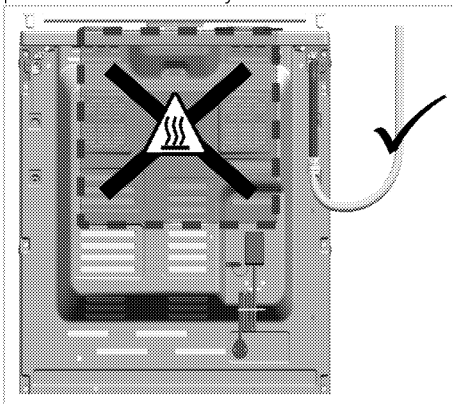

- If the gas hose outlet and the LPG cylinder do not face on the same side, make sure that the hose does not pass through the hot area when connecting it.

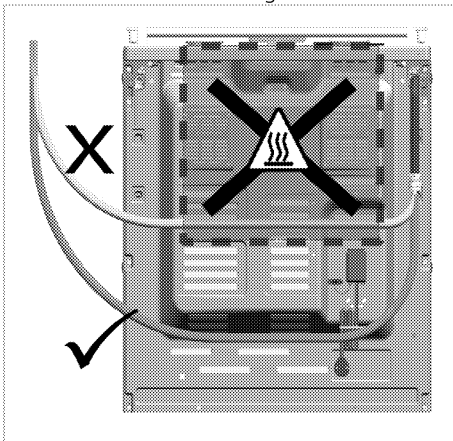

**If your product has two gas outlets;**

- One of the two outlets is sealed with a blind plug. The end of the other outlet is open.

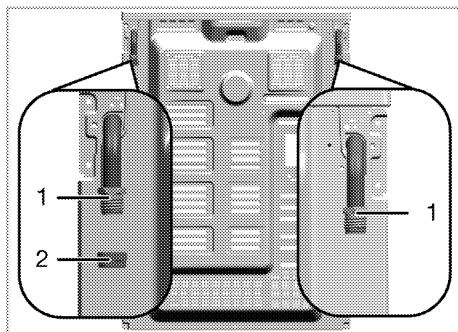

- 1 Gas hose outlet
- 2 Blind plug

(The outlet to which the blind plug is attached may vary depending on the product model.)

- Before gas connection, make sure that the LPG cylinder and the gas hose outlet of the product to be connected to the gas is on the same side.
- If the LPG cylinder and the open-ended gas hose outlet are on the same side, make the gas connection as shown in the figure below.

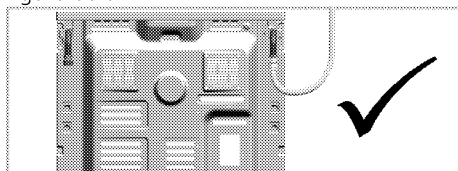

- If the LPG cylinder and the gas hose outlet sealed with the blind plug face on the same side, remove the blind plug from the gas hose outlet using two wrenches. Close the gas hose outlet with this blind plug where gas connection will not be made with a new (unused) sealing gasket.

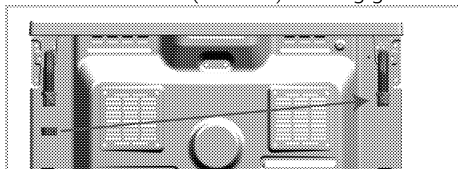

- Make the gas connection as shown in the figure below on the gas hose outlet near the LPG cylinder.

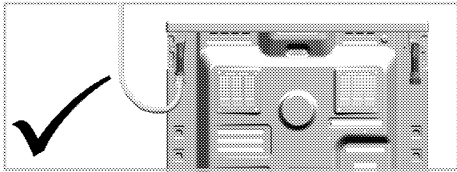



### Risk of fire:

If you do not make the connection according to the instructions below, there will be the risk of gas leakage and fire. **Our company cannot be held responsible for damages resulting from this.**

- Gas connection must be made by the authorised service provider only.
- Gas connection of the product must definitely be made through the gas hose outlet near the LPG cylinder.
- The gas hose outlet that will not be used must be sealed with the blind plug.
- When closing the gas hose outlet that will not be used, you must definitely use a new and unused sealing gasket.

 After changing the blind plug connection direction, gas leakage control should be done by the authorized service.

 The flexible gas hose must be connected in such a way that it does not touch the moving parts in the area where it is placed and does not get caught when the moving parts move.  
(e.g. drawer) Besides, it should not be placed in spaces where it might get squeezed.

 The gas hose must not be clamped, bent or trapped or come into contact with hot parts of the product. There is the risk of explosion due to damaged gas hose.

### Leakage check at the connection point

- Make sure that all knobs on the product are turned off. Make sure that the gas supply is open. Prepare soapy foam and apply it onto the connection point of the hose for gas leakage control.
- Soapy part will froth if there is a gas leakage. In this case, inspect the gas connection once again.
- **If your product has two gas outlets;** Make sure that the gas outlet that it not used is closed with a blind plug. Prepare soapy foam and apply it onto the connection point of the blind plug to check for gas leaks. Soapy part will froth if there is a gas leakage. In this case, inspect the blind plug connection again.
- Instead of soap, you can use commercially available sprays for gas leak check.

 Never use a match or lighter to make the gas leakage control.

### Placing the product

1. Push the product towards the kitchen wall.
2. Secure the safety chain you have connected to the product to the wall.
3. Vibrations during use may cause cooking vessels to move. This dangerous situation can be avoided if the product is level and balanced. For your safety, make sure that they are level when screwing all 4 feet. Balance the product by turning the feet to the right and left and align it level with the countertop.

### Final inspection

1. Open gas supply.
2. Check gas installations for secure fitting and tightness.
3. Ignite burners and check appearance of the flame.

 Flame must be blue and have a regular shape. If the flame is yellowish, check if the burner cap is seated securely or clean the burner.

## 5 First use

Before you start using your product, it is recommended to do the following in the following sections.

### First time setting

**i** Always set the time of day before using your oven. If you do not set it, you cannot cook in some oven models.

**i** The corresponding symbols on the watch flash while making any adjustments.

Set the time of day with the  $\oplus/\ominus$  keys after the oven is first powered up.

**i** On touch models, first touch the  $\frac{\text{time}}{\text{time}}$  key, then adjust the time of the day with  $\oplus/\ominus$ .

Confirm the setting by touching the  $\odot$  symbol or wait for 4 seconds to confirm without pressing any key.

**i** If the first time is not set, the clock will start moving from **12:00** and the  $\odot$  symbol will appear on the screen. The symbol will disappear when the time is set.

**i** Current time settings are canceled in case of power failure. It needs to be re-adjusted.

### First cleaning

1. Remove all packaging materials.
2. Remove all accessories from the oven provided within the product.
3. Turn the product on for 30 minutes and then, turn it off. This way, residues and layers that may have remained in the oven during production are burned and cleaned.
4. Select the highest operating level of the gas oven. You can learn how to operate the oven in the following section.
5. Wait for the oven to cool.
6. Wipe the surfaces of the product with a wet cloth or sponge and dry with a cloth.

### Before using the accessories;

Clean the accessories you remove from the oven with detergent water and a soft cleaning sponge.

**NOTICE** The surface might get damaged by some detergents or cleaning materials. Do not use aggressive detergents, cleaning powders/creams or any sharp objects during cleaning.

**NOTICE** Smoke and smell may emit for a couple of hours during the initial operation. This is quite normal. Ensure that the room is well ventilated to remove the smoke and smell. Avoid directly inhaling the smoke and the smell that emits.

## 6 How to use the hob

### General information on hob usage

#### General warnings

- Place pots and pans in a manner so that the handles are not over the burners to prevent them from overheating.
- Do not use unbalanced and easily tilting pots/pans on the hob.
- Do not heat the pots/pans and pots empty. The pots and the appliance may be damaged.
- Do not ignite the burners without any pot or pots/pans on the respective burner.
- Always turn off the hob's burners after each use.
- You shall damage the appliance if you operate the hobs without any pot or pots/pans. Always turn off the hobs after each operation.
- Put a sufficient amount of food in pots and pans. Thus, you can prevent food from pouring forth out of the pots/pans and will not need to clean unnecessarily.
- Do not place the covers of pots and pans on burners/zones.
- Place the pots by centering them on the burners/zones. If you wish to place a pot on a different burner/zone, do not slide it towards the desired burner; rather, lift it first and then put it on the other burner.
- The size of the cooking pots/pans shall match the size of the flame. Set the gas flames so that they shall not protrude from the base of the pots/pans and place the pots/pans on pot holder by centering it. Do not use large pans/pots to cover more than one burner.

#### Recommended cooking pots/pans sizes

Gas burners

Hob burner type	Pan diameter to be used
Auxiliary burner	16 - 18 cm
Normal burner	18 - 20 cm
Rapid burner	20 - 22 cm
Wok burner	22 - 24 cm



Do not use pots/pans that exceed the above stated dimensions. Using larger pans / pots than specified may cause carbon monoxide

poisoning and overheating of nearby surfaces and knobs. In addition, if the cooking surface of your product is glass, overheating will occur on this surface and the product will be damaged. The use of smaller pans / pots may cause you to burn due to flames.

### Operation of the hobs

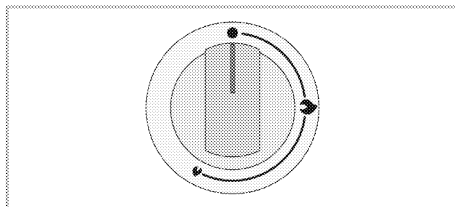
#### Gas level



The large fire symbol  indicates the maximum cooking gas level, the small fire symbol  indicates minimum cooking gas level. The gas provided to the hobs is cut off in the off position . Set your desired cooking power by aligning the knob to the respective symbol.

#### Igniting the gas burners

The gas burners are ignited with the control knobs.

1. Press on the burner knob.
2. With the resulting spark, the gas is ignited.
3. After the initial ignition, keep pressing on the knob for 3-5 seconds.
4. If the gas is not ignited after pressing on and releasing the knob, repeat the same process by pressing on the knob for 15 seconds.



Release the button if the burner is not ignited within 15 seconds.

Wait at least 1 minute before trying again. There is the risk of gas accumulation and explosion!

5. Adjust your desired power level.

#### Turning off the gas burners

Bring the burner knob to off position (top).



If the flames of the burner are extinguished inadvertently, turn off the burner control knob.

Do not attempt to ignite the burner again for 1 minute at least.

**Gas shut off safety assembly It varies depending on the product model. It may not be available on your product.**

As a precaution against blow out due to overflows over the gas burners, a safety mechanism starts to operate and shuts off the gas immediately.

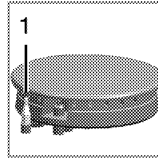

1 Gas shut-off safety

To activate the gas shut-off safety mechanism, keep the control knob pressed for 3-5 seconds more after igniting the hob.



Release the button if the burner is not ignited within 15 seconds.

Wait at least 1 minute before trying again. There is the risk of gas accumulation and explosion!



## 7 How to operate the oven

### General information on oven usage

#### Cooling fan (It may not exist on your product.)

Your product has a cooling fan. The cooling fan is activated automatically when necessary and cools both the front of the product and the furniture. It is automatically deactivated when the cooling process is finished. Hot air comes out over the oven door. Do not cover these ventilation openings with anything. Otherwise, the oven may overheat.

The cooling fan continues to operate during oven operation or after the oven is turned off (approximately 20-30 minutes). If you cook by programming the oven timer, at the end of the cooking time, the cooling fan turns off with all functions. The cooling fan running time cannot be determined by the user. It turns on and off automatically. This is not an error.

#### Oven lighting

You can turn on the oven lamp by pressing the lamp/roisserie button. Press the button again to turn it off.

#### Turning on the gas oven

The gas oven is turned on with gas oven control knob. The gas supply is locked in the closed position (top).

#### Igniting the gas oven

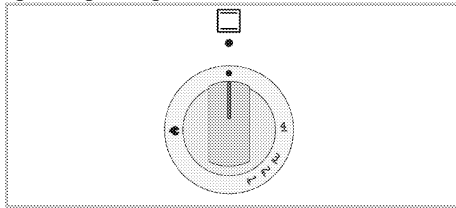

The gas oven is ignited with the ignition button.

1. Open the oven door.
2. Press and hold the control knob of the gas oven and **rotate it counter clockwise.**
3. Press the ignition button and release it.
4. Press and hold the gas oven control knob for 3 to 5 seconds.

- » Repeat the action until the gas is ignited. Make sure that the oven burner is ignited.
5. Press and hold the control knob of the gas oven for 3 to 5 seconds more.
  6. Select the desired oven gas power and release the gas oven control knob you are holding as pressed.
  7. If no power is available on your household, ignite your oven burner from the ignition control hole with a lighter or a match.

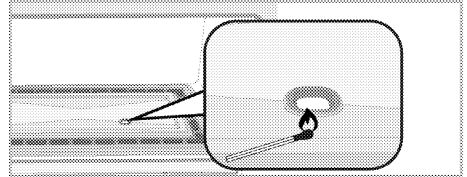

There is the risk of gas compression and explosion!

Do not attempt to ignite the gas more than 15 seconds. If the burner is not ignited within 15 seconds, turn off the knob and wait for 1 minute. Ventilate the room before reattempting to ignite the burner. There is the risk of gas compression and explosion!

8. Close the door of the oven.

#### Turning off the gas oven

1. Turn the gas oven control knob to off position (top).

#### Turning on the gas grill

Grill is operated with the gas oven control knob. The gas supply is locked in the closed position (top).



Close the oven door during grilling. Never grill with the oven door open. Hot surfaces may cause burns!

#### Igniting the gas grill

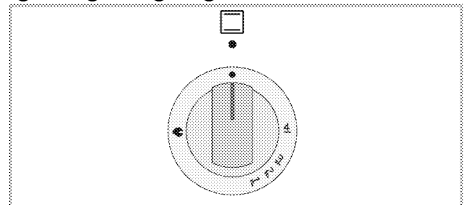

The gas grill is ignited with ignition button.

1. While pressing on the knob, rotate it **clockwise** and bring it to the grill symbol.
2. Press the ignition button and release it.  
» Repeat the action until the gas is ignited.
3. Keep the knob pressed for 3 to 5 seconds more.
4. Make sure that the grill is ignited and release the knob you are holding as pressed.
5. In case of a power failure, ignite the grill burner with a match or a lighter.

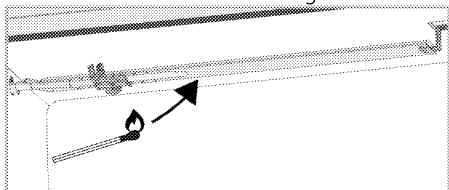

There is the risk of gas compression and explosion!

Do not attempt to ignite the gas more than 15 seconds. If the burner is not ignited within 15 seconds, turn off the knob and wait for 1 minute.

Ventilate the room before reattempting to ignite the burner. There is the risk of gas compression and explosion!

## Turning off the grill

1. Turn the oven control knob to off position (top).

## Using the timer

### General warnings



The timer has no effect on the oven. Gas does not cut off at the end of the cooking time.





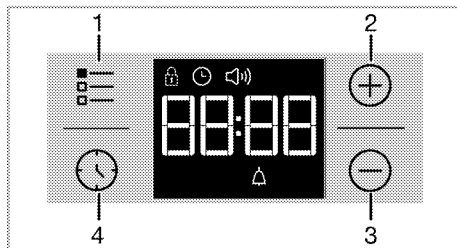

While making any setting, related symbols will flash on the display. You must wait for a short time for the settings to take effect.



- 1 Settings key
- 2 Increase key
- 3 Decrease key
- 4 Time setting key (The symbol may vary depending on your product. 🕒 / 🔔)

## Activating the keylock



You can prevent digital timer from being intervened with by activating the key lock function.

1. Touch  until  symbol appears on display.  
» "OFF" will appear on the display.
2. Press  to activate the key lock.  
» Once the key lock is activated, "On" appears on the display and the  symbol remains lit.



Digital timer keys are not functional when the key lock is activated. Key lock will not be cancelled in case of power failure.

## To deactivate the keylock

1. Touch  until  symbol appears on display.  
» "On" will appear on the display.
2. Disable the key lock by pressing the  key.  
» "OFF" will be displayed once the keylock is deactivated.



## Setting the alarm clock

You can use the timer of the product for any warning or reminder apart from the cooking program.

The alarm clock has no influence on the functions of the oven. It is only used as a warning. For example, this is useful when you want to turn food in the oven at a certain point of time. Timer will give an audio warning at the end of the set time.

1. Touch  until  symbol appears on display.

 Maximum alarm time can be 23 hours and 59 minutes.

2. Set the alarm duration by using  /  keys.

 Function keys for alarm tone, time of day, display brightness and temperature keys should be at 0 (OFF) position.

»  symbol will remain lit and the alarm time will appear on the display once the alarm time is set.



3. At the end of the alarm time,  symbol starts flashing and the audio warning is heard.

### Turning off the alarm

1. Audio warning sounds for 2 minutes. To stop the audio warning, just press any key.

» Audio warning will be silenced and current time will be displayed.



### Cancelling the alarm;



1. Touch  until  symbol appears on display in order to cancel the alarm.

2. Press and hold  key until "00:00" is displayed.

 Alarm time will be displayed. If the alarm time and cooking time are set concurrently, shortest time will be displayed.

### Changing alarm tone

1. Touch  until  symbol appears on display.



2. Adjust the desired alarm tone with  /  keys.



3. The tone you have set will be activated in a short time.

» Selected alarm tone will appear as "b-01", "b-02" or "b-03" on the display.

### Changing the time of the day

To change the time of the day you have previously set:

1. Touch  until  symbol appears on display.

2. Set the time of the day with  /  keys.



3. The time you have set will be activated in a short time.

### Setting the screen brightness

(This feature is optional. It may not exist on your product.)

1. Touch  until **d-01** or **d-02** or **d-03**

appears on display for display brightness.

2. Set the desired brightness with  /  keys.

» The time you have set will be activated in a short time.

### Rotisserie function

It is used to grill meat, poultry and fish evenly from all sides.

1. As shown in the figure, attach the rotisserie spit's hook to the hook slot.

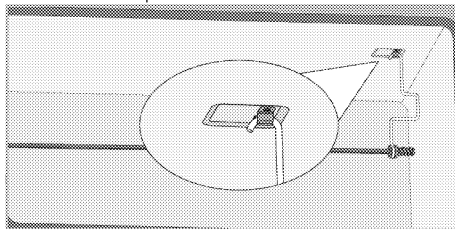

2. Fix the food to be grilled to the turn spit with the forks.

3. As shown in the figure, attach the rotisserie and skewer support wire into its place.

\*Rotisserie and skewer support wire and its place on the product, provided depending on the model. They may not be available on your product.

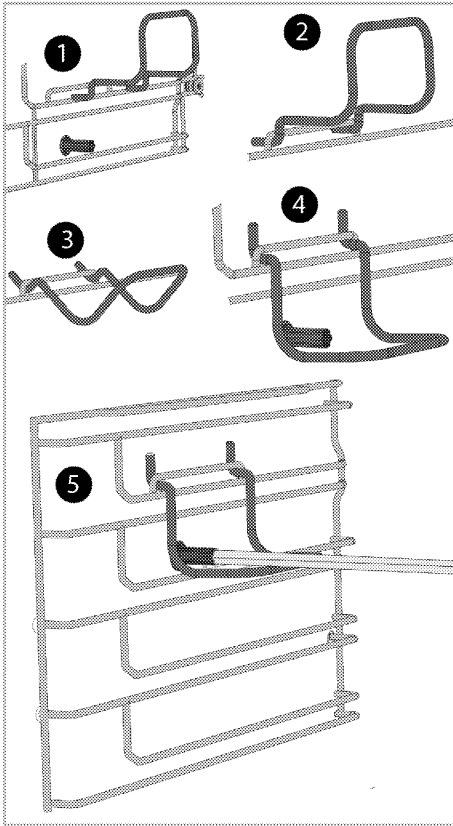

4. Place the pointed edge of the spit into the rotating slot on the left side inside the oven.
5. Remove the plastic handgrip if your rotating spit has it.
6. Hang the other end of the spit on the hook as shown in the figure below. Make sure the spit is secured on the hook as shown in the figure.

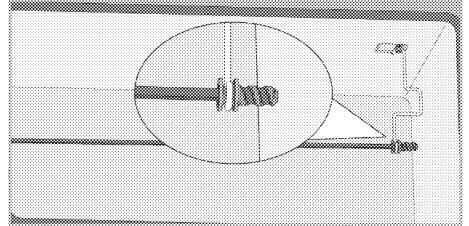

7. Place a tray on one of the lower shelves to collect the dripping oils. Put some water into the tray to facilitate cleaning.
8. Ignite the grill burner of your oven.
9. Press on the lamp/rotisserie button.
10. Take your food out of the oven by attaching the plastic handgrip to the spit when rotisserie completed.

**i** Foods such as chicken and turkey that you will rotisserie spit must be 5 kg maximum.

## 8 General information about cooking

This section describes tips on preparing and cooking your food.

In addition, you can also find some of the foods tested as producers and the most appropriate settings for these foods.

Appropriate oven settings and accessories for these foods are also indicated.

### General warnings about cooking with hob

- Never fill the pan with oil more than one third of it. Do not leave the hob unattended when heating oil. Overheated oils bring risk of fire. **Never attempt to extinguish a possible fire with water!** When oil catches fire, cover it with a fire blanket or damp cloth. Turn off the hob if it is safe to do so and call the fire department.
- Before frying foods, always remove their excess water and put them inside the heated oil slowly. Make sure that frozen foods are defrosted before frying.
- When heating oil, make sure that the pot you use is dry and keep its lid open.
- For recommendations on cooking with power saving, refer to the "Environmental Instructions" section.
- The cooking temperature and time values given for foods may vary depending on the recipe and amount. For this reason, these values are given as ranges.

### General warnings about cooking in the oven

- While opening the oven door during or after cooking, hot-burning steam may emerge. The steam may burn your hand, face and / or eyes. When opening the oven door, stay away.
- Intense steam generated during cooking may form condensed water drops on the interior and exterior of the oven and on the upper parts of the furniture due to the temperature difference. This is a normal and physical occurrence.
- The cooking temperature and time values given for foods may vary depending on the recipe and amount. For this reason, these values are given as ranges.

- Always remove unused accessories from the oven before you start cooking. Accessories that will remain in the oven may prevent your food from being cooked at the correct values.
- For foods that you will cook according to your own recipe, you can reference similar foods given in the cooking tables.
- Using the supplied accessories ensures you get the best cooking performance. Always observe the warnings and information provided by the manufacturer for the external cookware you will use.
- Cut the greaseproof paper you will use in your cooking in suitable sizes to the container you will cook. Greaseproof papers that are overflowing from the container can create a risk of burns and affect the quality of your cooking. Use the greaseproof paper you will use in the temperature range specified.
- For good cooking performance, place your food on the recommended correct shelf. Do not change the shelf position during cooking.

### Pastries and oven food

#### General Information

- We recommend using the accessories of the product for a good cooking performance. If you are going to use an external cookware, prefer dark, non-sticking and heat resistant ware.
- If preheating is recommended in the cooking table, be sure to put your food in the oven after preheating.
- If you are going to cook using cookware on the wire grill, place it in the middle of the wire grill, not near the back wall.
- All materials used in making pastry should be fresh and at room temperature.
- The cooking status of the products may vary depending on the amount of food and the size of the cookware.
- Metal, ceramic and glass molds extend the cooking time and the bottom surface of pastry foods do not brown evenly.
- If you use cooking paper during cooking, a little browning may be observed on the bottom surface of the food. In this case,

you may need to extend your cooking time about 10 minutes.

- The values specified in the cooking tables are determined as a result of the tests carried out in our laboratories. Values suitable for you may differ from these values.
- Place your food on the appropriate shelf recommended in the cooking table. Refer to the bottom shelf of the oven as shelf 1.

### Tips for baking cakes

- If the cake is too dry, increase the temperature by 10 ° C and shorten the baking time.
- If the cake is moist, use a small amount of liquid or reduce the temperature by 10 ° C.
- If the top of the cake is burnt, put it on the lower shelf, lower the temperature and increase the baking time.
- If it is cooked well inside but the outside is sticky, use a smaller amount of liquid, reduce the temperature and increase the cooking time.

### Tips for cooking pastries

- If the pastry is too dry, increase the temperature by 10 ° C and shorten the cooking time. Wet the dough sheets with a sauce consisting of milk, oil, egg and yoghurt mixture.
- If the pastry is getting cooked slowly, make sure that the thickness of the pastry you have prepared does not overflow the tray.
- If the pastry is browned on the surface but the bottom is not cooked, make sure that the amount of sauce you will use for the pastry is not too much at the bottom of the pastry. For an even browning, try to spread the sauce evenly between the dough sheets and the pastry.
- Bake your pastry in the position and temperature appropriate to the cooking table. If the bottom is still not browned enough, place it on a bottom shelf for the next cooking.

### Cooking table for pastries and oven food

Food	Tray amount	Accessory to be used	Gas level	Shelf position	Pre-heating mins.	Cooking time (min) (approx.)
Apple pie	Single tray	Round black metal mold, 20 cm in diameter on wire grill**	1	4	10	70 ... 95
Fruit pie	Single tray	Round black metal mold, 20 cm in diameter on wire grill**	1	4	10	70 ... 95
Tart	Single tray	Round black metal mold, 20 cm in diameter on wire grill**	1	4	10	80 ... 95
Cookie	Single tray	Standard tray*	1	4	-	35 ... 50
Pizza	Single tray	Standard tray*	1 ... 2	4	10	20 ... 25
Cakes in mold	Single tray	Cake mold on wire grill**	1	3	10	70 ... 85
Biscuit	Single tray	Standard tray*	1	4	10	25 ... 40
Macaroni in oven	Single tray	Standard tray*	1	3	10	50 ... 60
Victoria sandwich	Single tray	Standard tray*	1	3	10	20 ... 35

Pre-heating shall be performed at gas level 3.

\* These accessories may not be included with your product.

\*\* These accessories are not included with your product. They are commercially available accessories.

## Meat, Fish and Poultry

### The key points on roasting

- Seasoning it with lemon juice and pepper before cooking all chicken, turkey and large pieces of meat will increase cooking performance.
- It takes 15 to 30 minutes more to cook boned meat than fillet by roasting.
- You should calculate about 4 to 5 minutes of cooking time per centimeter of the meat thickness.
- After the cooking time is over, leave the meat in the oven for about 10 minutes. The juice of the meat is better distributed to the fried meat and does not come out when the meat is cut.
- Fish should be placed on a medium or low level shelf in a heat resistant plate.
- Cook the foods recommended in the cooking table with a single tray.

### Cooking table for meat, fish and poultry

Food	Tray amount	Accessory to be used	Gas level	Shelf position	Pre-heating mins.	Cooking time (min) (approx.)
Roast lamb	Single tray	Standard tray*	15 mins. 2 / then 1	3	10	70 ... 90
Steak (whole) / Roast	Single tray	Standard tray*	15 mins. 2 / then 1	3	10	70 ... 90
Turkey	Single tray	Standard tray*	2	2	10	100 ... 120
Poultry	Single tray	Wire grill* Place one tray on a lower shelf	15 mins. 2 / then 1	2	10	80 ... 100
Casserole	Single tray	Standard tray*	1	3	-	90 ... 120
Fish	Single tray	Wire grill* Place one tray on a lower shelf	1	3	10	30 ... 40

Pre-heating shall be performed at gas level 3.

\* These accessories may not be included with your product.

\*\* These accessories are not included with your product. They are commercially available accessories.

## Grill

Red meat, fish and poultry meat will quickly turn brown when grilled, hold a beautiful crust and do not dry out. Fillet meats, skewer meats, sausages as well as juicy vegetables (tomatoes, onions, etc.) are particularly suitable for grilling.

### General warnings

- Food not suitable for grilling carries a fire hazard. Grill only food that is suitable for heavy grill fire. Also, do not place the food too far in the back of the grill. This is the hottest area and fatty foods may catch fire.
- **Close the oven door during grilling. Never grill with the oven door open. Hot surfaces may cause burns!**

### The key points of the grill

- Prepare foods of similar thickness and weight as much as possible for the grill.
- Place the pieces to be grilled on the wire grill or wire grill tray by distributing them without exceeding the dimensions of the heater.
- Depending on the thickness of the pieces to be grilled, the cooking times given in the table may vary.
- Slide the wire grill or the wire grill tray to the desired level in the oven. If you are cooking on the wire grill, slide the oven tray to the lower shelf to collect the oils. The oven tray you are going to slide should be sized to cover the entire grill area. This tray may not be included with the product. Put some water into the oven tray for easy cleaning.

### Grilling table

Food	Preliminary preparation/settings	Cooking time (min) (approx.)*
Making toast from breads	...	3 ... 10
Small pieces of meat, sausage/pepperoni, salami	...	15 ... 20
Chops, hams, chicken pieces, etc.	Chicken with flipped grill	20 ... 25
All fish, fish fillets, fish fries	All fish and fish fillets placed under grill pan.	10 ... 20
Fish with crispy bread	...	15 ... 20
Pre-baked potato products	...	15 ... 20
Pizza	Placed under grill pan.	12 ... 15
Grilled/fried foods	Foods are directly placed under the grill.	8 ... 10

\* by size and thickness respectively



## 9 Maintenance and care

### General cleaning information

#### General warnings

- Wait for the product to cool before cleaning the product. Hot surfaces may cause burns!
- Do not apply the detergents directly on the hot surfaces. This may cause a permanent stains.
- The appliance shall be thoroughly cleaned and dried after each operation. Thus, food residues shall be easily cleaned and these residues shall be prevented from burning when the appliance is used again later. Thus, the service life of the appliance extends and frequently faced problems are decreased.
- Do not use steam cleaning products for cleaning.
- Some detergents or cleaning agents may damage the surface. Do not use abrasive detergents, cleaning powders, cleaning creams, descalers or sharp objects during cleaning.
- There is no need for a special cleaning agent for cleaning after each use. Clean the appliance using dish soap, warm water and a soft cloth or sponge and dry with a dry microfiber cloth.
- Be sure to completely wipe off any remaining liquid after cleaning and immediately clean any food splashing around during cooking.
- Do not wash any component of your appliance in a dishwasher.

#### For the hob:

- Acidic dirt such as milk, tomato paste and oil may cause permanent stains on the hobs and components of the burners/hotplates, clean any overflow fluids immediately after cooling down the hob by turning it off.
- Wok type vessels used at high temperatures may change colour. This is normal.
- Moving some cookware may cause metal marks on the pot holders. Do not slide the pans and pots on the surface.
- As burner caps contact the fire directly and exposed to high temperatures,

change and loss of colour in time is normal. This does not cause a problem while using the hob.

#### Inox and stainless surfaces

- Do not use acid or chlorine-containing cleaning agents to clean stainless or inox surfaces and handles.
- Stainless or inox surface may change colour in time. This is normal. After each operation, clean with a detergent suitable for the stainless or inox surface.
- Clean with a soft soapy cloth and liquid (non-scratching) detergent suitable for inox surfaces, taking care to wipe in one direction.
- Remove lime, oil, starch, milk and protein stains on the inox-stainless and glass surfaces immediately without waiting. Stains may rust under long periods of time.

#### Enamelled surfaces

- After each use, clean the enamel surfaces using dishwashing detergent, warm water and a soft cloth or sponge and dry them with a dry cloth.
- If your product has an easy steam cleaning function, you can make easy steam cleaning for light non-permanent dirt. (See the "Easy steam cleaning" section)
- For persistent stains, the oven and grill cleaner recommended on the website of your product brand and a non-scratching scouring pad can be used. Do not use an external oven cleaner.
- The oven must cool down for cleaning in the cooking area. Cleaning on hot surfaces shall create both fire hazard and damage with enamel surface.

#### Catalytic surfaces

- The side walls in the cooking area can only be covered with enamel or catalytic walls. It varies by model.
- The catalytic walls have a light matte and porous surface. The catalytic walls of the oven should not be cleaned.
- Catalytic surfaces absorb oil thanks to its porous structure and start to shine when the surface is saturated with oil, in this

case it is recommended to replace the parts.

### **Glass surfaces**

- When cleaning glass surfaces, do not use hard metal scrapers and abrasive cleaning materials. They can damage the glass surface.
- Clean the appliance using dishwashing detergent, warm water and a microfiber cloth specific for glass surfaces and dry it with a dry microfiber cloth.
- If there is residual detergent after cleaning, wipe it with cold water and dry with a clean and dry microfiber cloth. Residual detergent residue may damage the glass surface next time.
- Under no circumstances should the dried-up residue on the glass surface be cleaned off with serrated knives, wire wool or similar scratching tools.
- You can remove the calcium stains (yellow stains) on the glass surface with the commercially available descaling agent, with a descaling agent such as vinegar or lemon juice.
- If the surface is heavily soiled, apply the cleaning agent on the stain with a sponge and wait a long time for it to work properly. Then clean the glass surface with a wet cloth.
- Discolorations and stains on the glass surface are normal and not defects.

### **Plastic parts and painted surfaces**

- Clean plastic parts and painted surfaces using dishwashing detergent, warm water and a soft cloth or sponge and dry them with a dry cloth.
- Do not use hard metal scrapers and abrasive cleaners. It may damage the surfaces.
- Ensure that the joints of the components of the appliance are not left as damp and with detergent. Otherwise, corrosion may occur on these joints.

### **Cleaning the accessories**

Unless otherwise stated in the user manual, do not wash the product accessories in the dishwasher.

## **Cleaning the hob**

### **Cleaning the gas burners**

1. Before cleaning the hob, remove pot holders, burner caps and heads from the hob.
2. Clean the surface of the hob as per the recommendations included in the general cleaning information according to the surface type (enamelled, glass, inox, etc.).
3. Clean the burner chamber with a cloth soaked in detergent or with non-scratching, soft brush. Ensure that no food remains are left.
4. Clean the spark plugs and thermal elements (in models with ignition and thermal element) with a well squeezed cloth. Then dry with a clean cloth. Pay attention that the spark plug and the thermal element are completely dry.
5. Clean the burner caps and heads with detergent water after each operation and then dry them.
6. For persistent stains, keep burner caps and heads in detergent water or warm soapy water at least for 15 minutes. Clean with a non-metallic and non-scratching brush.
7. You may use the Quick&Shine cleaning agents for the oven interiors and grills, used on enamelled surfaces and recommended by the authorized service, especially for persistent stains on enamelled burner caps.
8. Do not contact burner caps with aggressive detergents such as oven interior cleaning agents, descalers while cleaning them, this may cause discolouration.
9. Clean the pot holders with detergent water and non-scratching, soft brush after each operation and then dry them.
10. When the burner caps and pot holders are used as wet, persistent lime stains may occur as a result of the heat. Ensure that it is dried before operation.
11. Place burner heads, caps and pot holders respectively.
12. When placing the pot holders, ensure that they centre the burners. In pin

models, fit the pins on the burner plate to the pin slots on the pot holders.

### Assembling the burner parts

Place the parts as in the figure after cleaning the burners.

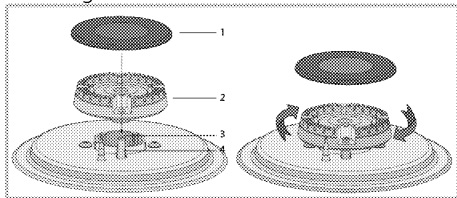

- 1 Burner cap
- 2 Burner head
- 3 Burner chamber
- 4 Spark plug (in models with ignition)

1. Place the burner head ensuring that it passes through the burner spark plug (4). Turn the burner head right and left to make sure that it is seated in the burner chamber.
2. Place the burner cap on the burner head.

### Cleaning the control panel

- When cleaning the panels with knob control, wipe the panel and knobs with a damp soft cloth and dry with a dry cloth. Do not remove the knobs and gaskets underneath to clean the control panel. The control panel and knobs may be damaged.
- While cleaning the inox panels with knob control, do not use inox cleaning agents around the knobs. The indicators around the knobs may be deleted.
- Clean the touch control panels with a damp soft cloth and dry with a dry cloth. If your product has a key lock feature, set the key lock before performing control panel cleaning. Otherwise, incorrect detection may occur on the keys.

### Cleaning the inside of the oven (cooking area)

Follow the cleaning steps described in the "General cleaning information" section according to the surface types in your oven.

#### Cleaning the side walls of the oven

The side walls in the cooking area can only be covered with enamel or catalytic walls. It varies by model. If there is a catalytic wall,

refer to the "Catalytic walls" section for information.

If your product is a side rack model, remove the side racks before cleaning your side walls. Then complete the cleaning as described in the "General cleaning information" section according to the side wall surface type.

#### To remove the side racks:

1. Remove the front of the side rack by pulling it on the side wall in the opposite direction.
2. Pull the side rack towards you to remove it completely.

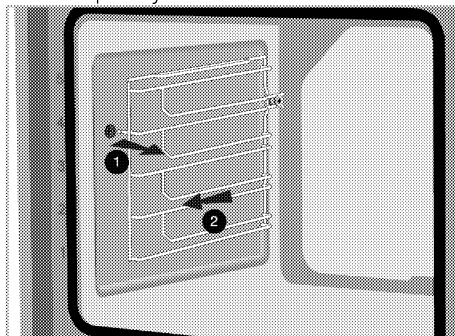

3. To reattach the shelves, the procedures applied when removing them must be repeated from the end to the beginning, respectively.

### Cleaning the oven door

- i** Do not use harsh abrasive cleaners, metal scrapers, wire wool or bleach materials to clean the oven door and glass.

You can remove your oven door and door glasses to clean them. How to remove the doors and windows is explained in the sections "Removing the oven door" and "Removing the inner glasses of the door". After removing the door inner glasses, clean them using a dishwashing detergent, warm water and a soft cloth or sponge and dry them with a dry cloth. Wipe the glass with vinegar and then rinse it against lime residues that may occur on the oven glass.

#### Removing the oven door

1. Open the oven door.

2. Open the clips in the front door hinge socket on the right and left by pressing downwards as shown in the figure. The hinge type (A), (B), (C) varies according to the product model. The figures below show how to open all hinge types. (A) type hinge is available in normal door types. (B) type hinge is available in soft closing door types. (C) type hinge is available in soft opening/closing door types.

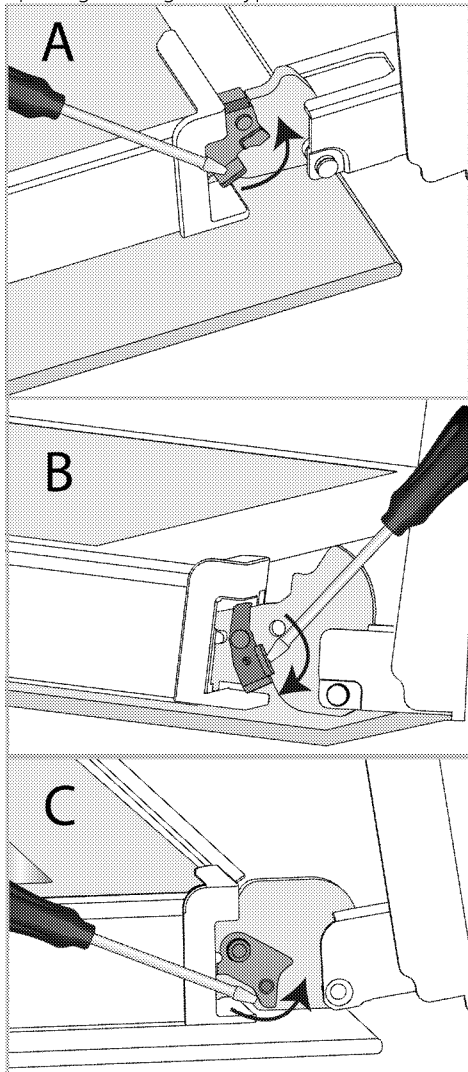

Hinge lock - closed position

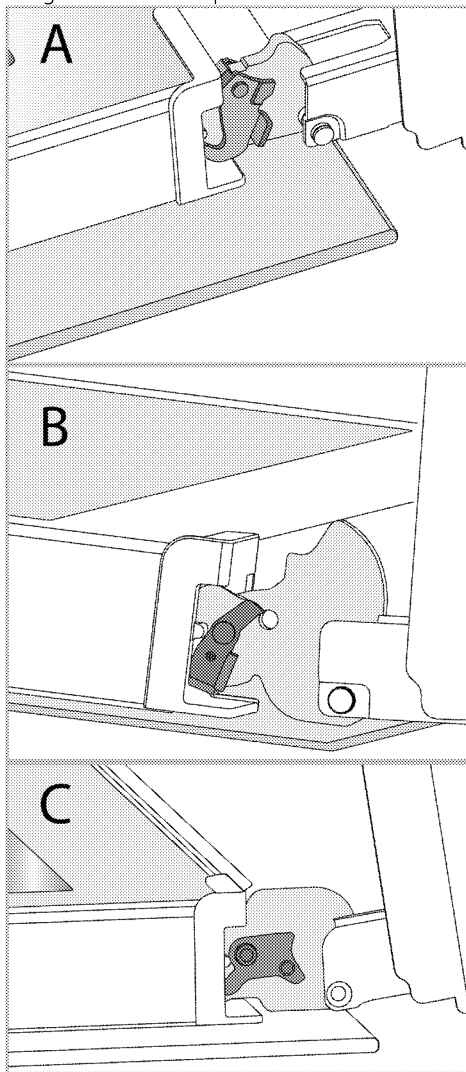

Hinge lock - open position

3. Get the oven door to a half-open position.

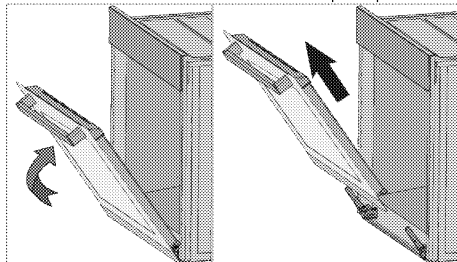

4. Pull the removed door upwards to release it from the right and left hinges and remove it.

**i** To reattach the door, the procedures applied when removing it must be repeated from the end to the beginning, respectively. When installing the door, be sure to close the clips on the hinge socket.

## Removing the inner glass of the oven door

Inner glass of the product's front door of may be removed for cleaning.

1. Open the oven door.

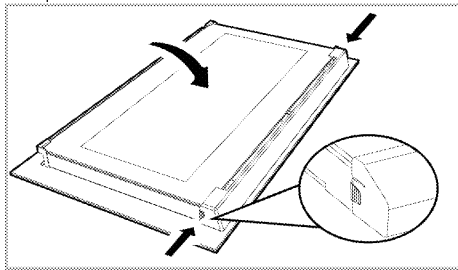

2. Pull the plastic component, attached on the upper section of the front door, towards yourself by simultaneously pressing on the pressure points on both sides of the component and remove it.

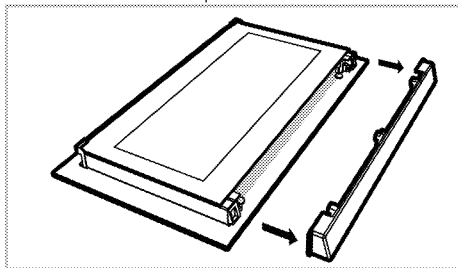

3. As shown in the figure, gently lift the innermost glass (1) towards 'A' and then, remove it by pulling towards 'B'.

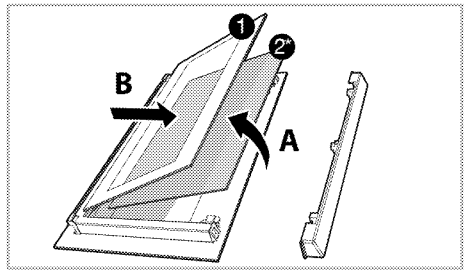

1 Innermost glass panel

2\* Inner glass panel (It may not exist on your product.)

4. If your product has an inner glass (2), repeat the same process to detach it (2).
5. The first step of regrouping the door is to reassemble the inner glass (2). Place the beveled edge of the glass to meet the beveled edge of the plastic slot. (If your product has an inner glass). Inner glass (2) must be attached to the plastic slot closest to the innermost glass (1).
6. While reassembling the innermost glass (1), pay attention to place the printed side of the glass on the inner glass. It is crucial to place the lower corners of the innermost glass (1) to meet the lower plastic slots.
7. Push the plastic component towards the frame until a "click" sound is heard.

## Cleaning the oven lamp

In the event that the glass door of the oven lamp in the cooking area becomes dirty; clean using dishwashing detergent, warm water and a soft cloth or sponge and dry with a dry cloth. In case of oven lamp failure, you can replace the oven lamp by following the sections that follow.

## Replacing the oven lamp

### ⚠ General warnings

- To avoid the risk of electric shock before replacing the oven lamp, disconnect the electrical connector and wait for the oven to cool. Hot surfaces may cause burns!
- In this oven, an incandescent lamp with a power of less than 40 W, a height of less than 60 mm, a diameter of less than 30 mm or a halogen lamp with socket type G9, a power of less than 60 W is used.

The lamps are suitable for operation at temperatures above 300 °C. Oven lamps can be obtained from Authorised Service Agents or technician with licence.

- The position of the lamp may differ from that is shown in the figure.
- The lamp used in this product is not suitable for use in the lighting of home rooms. The purpose of this lamp is to help the user see food products.
- The lamps used in this product must withstand extreme physical conditions such as temperatures above 50 ° C.

**If your oven has a round lamp,**

1. Disconnect the product from the electricity.
2. Remove the glass cover by turning it counterclockwise.

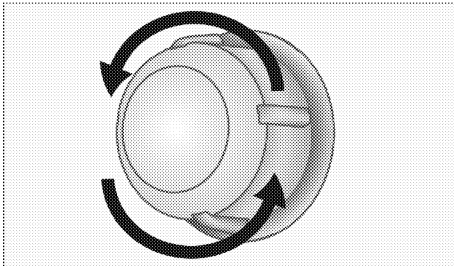

3. If your oven lamp is type (A) shown in the figure below, rotate the oven lamp as shown in the figure and replace it with a new one. If type (B) is a model, pull it out as shown in the figure and replace it with a new one.

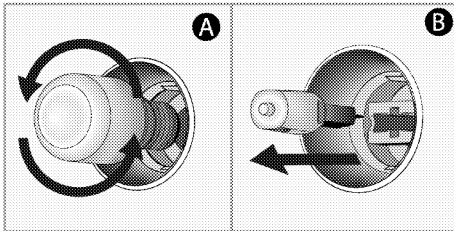

4. Refit the glass cover.

**If your oven has a square lamp,**

1. Disconnect the product from the electricity.
2. Remove the wire shelves according to the description.

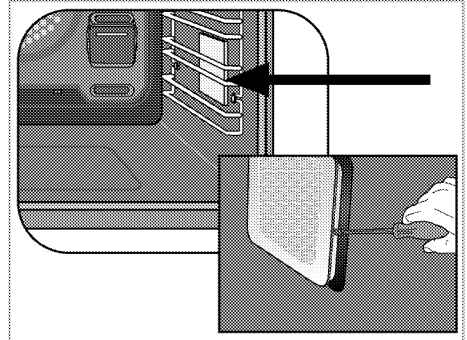

3. Lift the lamp's protective glass cover with a screwdriver.
4. If your oven lamp is type (A) shown in the figure below, rotate the oven lamp as shown in the figure and replace it with a new one. If type (B) is a model, pull it out as shown in the figure and replace it with a new one.

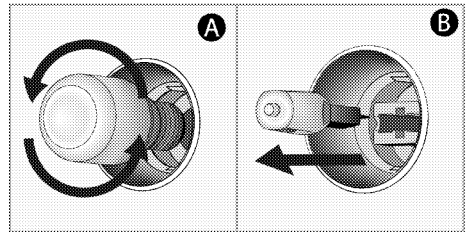

5. Refit the glass cover and wire shelves.

## 10 Troubleshooting

Consult the Authorised Service Agent or technician with license or the dealer where you have purchased the product if you cannot remedy the trouble although you have implemented the instructions in this section. Never attempt to repair a defective product yourself.

### Oven emits steam when it is in use.

- It is normal that steam escapes during operation. >>> *This is not a fault.*

### Water drops occur during cooking.

- The vapour that arises during cooking can condense and form water droplets when it hits cold surfaces of the product. >>> *This is not a fault.*

### Product emits metal noises while heating and cooling.

- When the metal parts are heated, they may expand and cause noise. >>> *This is not a fault.*

### Oven light does not work.

- Oven lamp is defective. >>> *Replace oven lamp.*
- Power is cut. >>> *Check if there is power. Check the fuses in the fuse box. If necessary, replace or reset the fuses.*

### There is no ignition spark.

- No current. >>> *Check fuses in the fuse box.*
- Time is not set. >>> *Set the time.*

### There is no gas.

- Main gas valve is closed. >>> *Open gas valve.*
- Gas pipe is bent. >>> *Install gas pipe properly.*

### Burners are not burning properly or at all.

- Burners are dirty. >>> *Clean burner components.*
- Burners are wet. >>> *Dry the burner components.*
- Burner cap is not mounted safely. >>> *Mount the burner cap properly.*
- Gas valve is closed. >>> *Open gas valve.*
- Gas cylinder is empty (when using LPG). >>> *Replace gas cylinder.*

### Baking takes too long.

- Pipe pressure is low. >>> *Adjust a higher gas mark.*

### (In models with timer) Clock display is blinking or clock symbol is on.

- A previous power outage has occurred. >>> *Adjust the time / Switch of the product and switch it on again.*

