

Dryer

User Manual

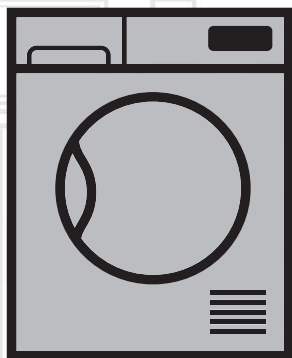

DCR 93161 W
DCY 9316 G

EN

2960311348_EN/230318.1637

CE

beko

Please read this user manual first!

Dear Customer,

Thank you for preferring a Beko product. We hope that your product which has been manufactured with high quality and technology will give you the best results. We advise you to read through this manual and the other accompanying documentation carefully before using your product and keep it for future reference. If you transfer the product to someone else, give its manual as well. Pay attention to all details and warnings specified in the user manual and follow the instructions given therein.







Use this user manual for the model indicated on the cover page.



Read the instructions.

Explanation of symbols

Throughout this user manual the following symbols are used:

| | |
|--|--|
|  | Important information or useful hints about usage. |
|  | Warning for hazardous situations with regard to life and property. |
|  | Warning against electric shock. |
|  | Warning against hot surfaces. |
|  | Warning against fire hazard. |
|  | Packaging materials of the product are manufactured from recyclable materials in accordance with our National Environment Regulations. |

Do not dispose of the packaging wastes with the domestic waste or other wastes, discard them to the dedicated collection points designated by the local authorities.

This product was manufactured using the latest technology in environmentally friendly conditions.

TABLE OF CONTENTS

| | | | |
|---|-----------|--|-----------|
| 1 Important safety and environmental instructions | 4 | 6 Operating the product | 19 |
| 1.1 General safety | 4 | 6.1 Control panel..... | 19 |
| 1.1.1 Electrical safety | 5 | 6.2 Screen symbols | 19 |
| 1.1.2 Product safety | 6 | 6.3 Preparing the machine..... | 20 |
| 1.2 Mounting over a washing machine | 8 | 6.4 Programme selection | 20 |
| 1.3 Intended use | 9 | 6.5 Main Programmes | 20 |
| 1.4 Child safety..... | 9 | 6.6 Extra Programmes | 20 |
| 1.5 Compliance with the WEEE regulation and disposing of the waste product..... | 10 | 6.7 Programme selection and consumption table..... | 22 |
| 1.6 Compliance with RoHS Directive:..... | 10 | 6.8 Auxiliary function..... | 23 |
| 1.7 Package information | 10 | 6.9 Warning symbols | 23 |
| 1.8 Technical specifications | 11 | 6.10 End duration..... | 23 |
| 2 Your Dryer | 12 | 6.11 Starting the Programme..... | 24 |
| 2.1 Overview..... | 12 | 6.12 Child lock | 24 |
| 2.2 Package contents..... | 13 | 6.13 Changing the Programme after it has started | 24 |
| 3 Installation | 14 | 6.14 Cancelling the Programme..... | 25 |
| 3.1 Appropriate installation location | 14 | 6.15 Programme end | 25 |
| 3.2 Removing the transportation safety assembly | 14 | 7 Maintenance and cleaning | 26 |
| 3.3 Under counter installation..... | 14 | 7.1 Cleaning lint filter / Loading door inner surface..... | 26 |
| 3.4 Adjusting the feet..... | 15 | 7.2 Cleaning the sensor | 27 |
| 3.5 Electrical connection..... | 15 | 7.3 Draining the water tank..... | 27 |
| 3.6 Transportation of the machine..... | 15 | 7.4 Cleaning the condenser | 28 |
| 3.7 Changing the illumination lamp | 15 | 8 Troubleshooting | 29 |
| 4 Electrical Connection | 16 | 9 Service | 31 |
| 4.1 Attention!..... | 16 | | |
| 4.2 Electrical requirements..... | 16 | | |
| 4.3 Fitting a different plug..... | 16 | | |
| 4.4 Washer/dryer combination..... | 16 | | |
| 5 Preparations | 17 | | |
| 5.1 Laundry suitable for drying in the dryer17 | | | |
| 5.2 Laundry not suitable for drying in the dryer | 17 | | |
| 5.3 Preparing laundry for drying..... | 17 | | |
| 5.4 Things to be done for energy saving | 17 | | |
| 5.5 Correct load capacity..... | 18 | | |

1 Important safety and environmental instructions

This section contains safety instructions that will help protect from risk of personal injury or property damage. Failure to follow these instructions shall void any warranty.

1.1 General safety

- The dryer can be used by children at and above 8 years old and by persons whose physical, sensory or mental capabilities were not fully developed or who lack experience and knowledge provided that they are supervised or trained on the safe usage of the product and the risks it brings out. Children should not play with the product. Cleaning and maintenance works should not be performed by children unless they are supervised by someone.
- Children of less than 3 years should be kept away unless continuously supervised.
- Adjustable feet should not be removed. The gap between the dryer and the floor should not be reduced with materials such as carpet, wood and tape. This will cause problems with the dryer.
- Always have the installation and repairing procedures carried out by the **Authorised Service**. Manufacturer shall not be held liable for damages that may arise from procedures carried out by unauthorised persons.
- Never wash the dryer by spraying or pouring water onto it! There is the risk of electric shock!

Important instructions for safety and environment

1.1.1 Electrical safety



Electrical safety instructions should be followed while electrical connection is made during the installation.



The appliance must not be supplied through an external switching device, such as a timer, or connected to a circuit that is regularly switched on and off by utility.

- Connect the dryer to a grounded outlet protected by a fuse at the value specified on the type label. Have the grounding installation performed by a qualified electrician. Our company shall not be liable for any damages that will arise when the dryer is used without grounding in accordance with the local regulations.
- The voltage and allowed fuse protection is stated on the type label plate.
- The voltage specified on the type label must be equal to your mains voltage.
- Unplug the dryer when it is not in use.
- Unplug the dryer from the mains during installation, maintenance, cleaning and repair works.
- Do not touch the plug with wet hands! Never unplug by pulling on the cable, always pull out by grabbing the plug.
- Do not use extension cords, multi-plugs or adaptors to connect the dryer to power supply in order to decrease the risk of fire and electric shock.
- Power cable plug must be easily accessible after installation.



Damaged mains cable should be changed by an Authorised Service agent.

Important instructions for safety and environment



If the dryer is faulty, it must not be operated unless it is repaired by an authorised service agent! There is the risk of electric shock!

1.1.2 Product safety



Superheating of the clothes inside of the dryer can occur if you cancel the programme or in the event of a power failure whilst the dryer is running, this concentration of heat can cause self-combustion and fire so always activate the ventilation programme to cool down or quickly remove all laundry from the dryer in order to hang them up and dissipate the heat.



Points to be taken into consideration for fire hazard:

Below specified laundry or items must not be dried in the dryer because of fire hazard.

- Unwashed laundry items
- Items soiled with oil, acetone, alcohol, fuel oil, kerosene, stain removers, turpentine, paraffin or solvents must be washed in hot water with plenty of detergent before being dried in the dryer.

Important instructions for safety and environment



Below specified laundry or items must not be dried in the dryer due to the fire hazard:

- Garments or pillows bolstered with rubber foam (latex foam), shower caps, water resistant textiles, materials with rubber reinforcement and rubber foam pads.
 - Clothing cleaned with industrial chemicals.
- Items such as lighters, matches, coins, metal parts, needle etc. may damage the drum set or may lead to functional problems. Therefore check pockets off the laundry that you will load into your dryer. Never stop your dryer before the programme completes. If you must do this, remove all laundry quickly and lay them out to dissipate the heat.



Clothes that are washed inadequately may ignite on their own and even may ignite after drying ends.

- You must provide enough ventilation in order to prevent gases exiting from devices operating with other types of fuels including the naked flame from accumulating in the room due to the back fire effect.



Clothing that contains metal reinforcements should not be dried in the dryer. Dryer may be damaged if metal reinforcements come loose and break off during drying.



Use softeners and similar products in accordance with the instructions of their manufacturers.



Always clean the lint filter before or after each loading. Never operate the dryer without the lint filter installed.

Important instructions for safety and environment

- Never attempt to repair the dryer by yourself. Do not perform any repair or replacement procedures on the product even if you know or have the ability to perform the required procedure unless it is clearly suggested in the operating instructions or the published service manual. Otherwise, you will be putting your life and others' lives in danger.
- There must not be a lockable, sliding or hinged door that may block the opening of the loading door in the place where your dryer is to be installed.
- Install your dryer in a suitable place that is dry, well ventilated and unlikely to get below 5 degrees Centigrade.
- Make sure that pets do not enter the dryer. Check the inside of the dryer before operating it.
- Do not lean on the loading door of your dryer when it is open, otherwise it may fall over.
- The lint must not be allowed to accumulate around the tumble dryer.
- The tumble dryer is not to be used if industrial chemicals have been used for cleaning.
- Fabric softeners, or similar products, should be used as specified by the fabric softener instructions.
- Exhaust air must not be discharged into a flue which is used for exhausting fumes from appliances burning gas or other fuels.

1.2 Mounting over a washing machine

- A fixing device should be used between the two machines when installing the dryer above a washing machine. The fitting device can be obtained through spare part suppliers.

Important instructions for safety and environment

- Total weight of the washing machine and the dryer -with full load- when they are placed on top of each other reaches to approx. 180 kilograms. Place the products on a solid floor that has sufficient load carrying capacity!



Washing machine cannot be placed on the dryer. Pay attention to the above warnings during the installation on your washing machine.

Installation Table for Washing Machine and Dryer

| Dryer Depth | Washing Machine Depth | | | | | | |
|-------------|-----------------------|-------|-------|-------|-------|-------------------|-------------------|
| | 62 cm | 60 cm | 54 cm | 50 cm | 49 cm | 45 cm | 40 cm |
| 54 cm | Can be stacked | | | | | Can be stacked | Cannot be stacked |
| 60 cm | Can be stacked | | | | | Cannot be stacked | |

1.3 Intended use

- Dryer has been designed for domestic use. It is not suitable for commercial use and it must not be used out of its intended use.
- Use the dryer only for drying laundry that are marked accordingly.
- The manufacturer waives any responsibility arisen from incorrect usage or transportation.
- Original spare parts will be available to repair the dryer for a period of 10 years.

1.4 Child safety

- Packaging materials are dangerous for the children. Keep packaging materials away from children.
- Electrical products are dangerous for the children. Keep children away from the product when it is operating. Do not let them tamper with the dryer. Use the child-proof

Important instructions for safety and environment

lock in order to prevent the children to tamper with the dryer.



Child-proof lock is on the control panel.
(See Child lock)

- Keep loading door closed even when the dryer is not in use.

1.5 Compliance with the WEEE regulation and disposing of the waste product

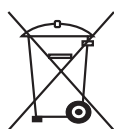

This product complies with EU WEEE Directive (2012/19/EU). This product bears a classification symbol for waste electrical and electronic equipment (WEEE).

This product has been manufactured with high quality parts and materials which can be reused and are suitable for recycling. Do not dispose of the waste product with normal domestic and other wastes at the end of its service life. Take it to the collection center for the recycling of electrical and electronic equipment. Please consult your local authorities to learn about these collection centers.

1.6 Compliance with RoHS Directive:

The product you have purchased complies with EU RoHS Directive (2011/65/EU). It does not contain harmful and prohibited materials specified in the Directive.

1.7 Package information

Packaging materials of the product are manufactured from recyclable materials in accordance with our National Environment Regulations. Do not dispose of the packaging materials together with the domestic or other wastes. Take them to the packaging material collection points designated by the local authorities.

Important instructions for safety and environment

1.8 Technical Specifications

EN



| | |
|--------------------------|--------------------|
| Height (Min. / Max.) | 84,6 cm / 86,6 cm* |
| Width | 59,7 cm |
| Depth | 65,4 cm |
| Capacity (max.) | 9 kg** |
| Net weight (\pm 4 kg) | 40 kg |
| Width | See type label*** |
| Voltage | |
| Rated power input | |

* Min. height: Height with adjustable feet are closed.

Max. height: Height with adjustable feet are opened maximum.

** Dry laundry weight before washing.

*** For the location of the type label on the dryer (**see 2.1 Overview.**)

| | |
|--|--|
|  | Technical specifications of the dryer are subject to specification without notice to improve the quality of the product. |
|  | Figures in this manual are schematic and may not match the product exactly. |
|  | Values stated on markers on the dryer or in the other published documentation accompanying with the dryer are obtained in laboratory in accordance with the relevant standards. Depending on operational and environmental conditions of the dryer, these values may vary. |

2 Your Dryer

2.1 Overview

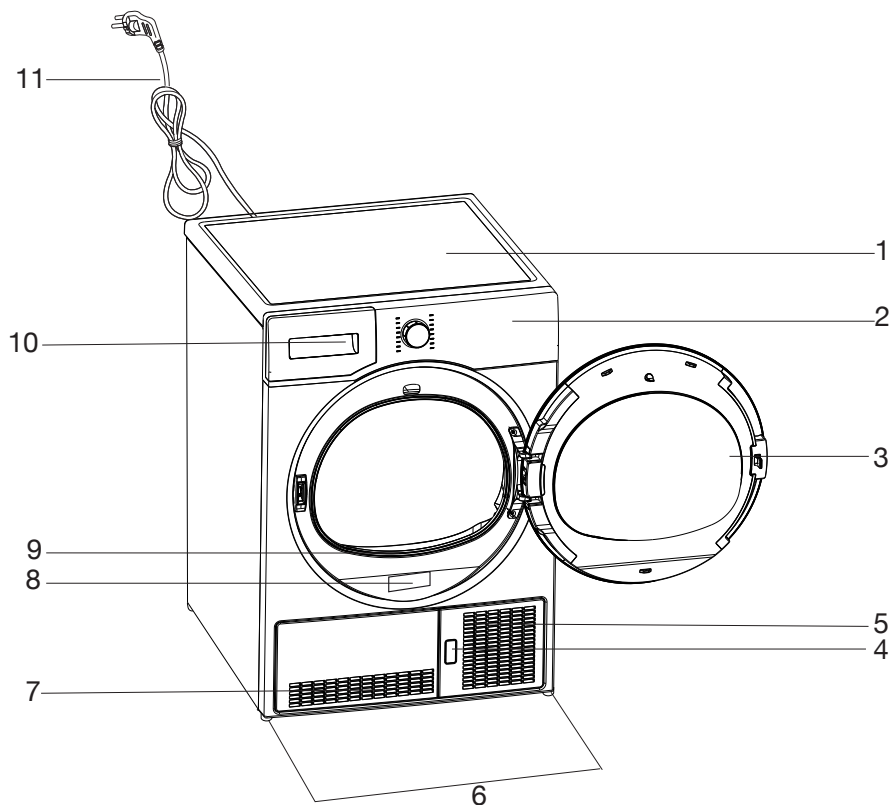

1. Top panel
2. Control panel
3. Loading door
4. Kick plate opening button
5. Ventilation grids
6. Adjustable feet
7. Kick plate
8. Type label
9. Lint filter
10. Water tank drawer
11. Power cord

2.2 Package Contents

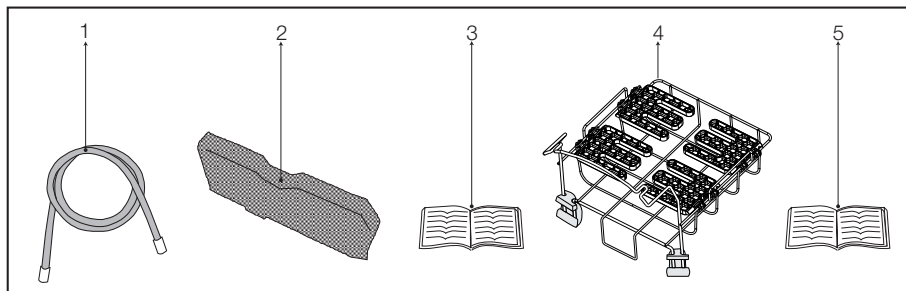

1. Water drain hose *
2. Filter drawer spare sponge*
3. User Manual
4. Drying basket*
5. Drying basket user manual*

*It can be supplied with your machine depending on its model.

3 Installation

Before the calling the nearest Authorized Service for the installation of the dryer, ensure that electrical installation and water drain is appropriate referring to the user's manual. **(See 3.3 Connecting to the drain and 3.5 Electrical connection)** If they are not suitable, contact a qualified electrician and technician to make necessary arrangements.



Preparation of the dryer's location as well as the electrical and waste water installations is under customer's responsibility.



Prior to installation, visually check if the dryer has any defects on it. If the drier is damaged, do not have it installed. Damaged products cause risks for your safety.

3.1 Appropriate installation location

Install the dryer on a stable and level surface. Dryer is heavy. Do not move it by yourself.

- Operate your dryer in a well ventilated, dust-free environment.
- The gap between the dryer and the surface should not be reduced by the materials such as carpet, wood and tape.
- Do not cover the ventilation grills of the dryer.
- There must not be a lockable, sliding or hinged door that may block the opening of the loading door in the place where your dryer is to be installed.
- Once the dryer is installed, it should stay at the same place where its connections have been made. When installing the dryer, make sure that its rear wall does not touch anywhere (tap, socket, etc.).
- Place the dryer at least 1 cm away from the edges of other furniture.
- Your dryer can be operated at temperatures between +5°C and +35°C. If the operating conditions fall outside of this range, operation of the dryer will be adversely affected and it can get damaged.
- The rear surface of the tumble dryer shall be placed against a wall.



Do not place the dryer on the power cable.

3.2 Removing the transportation safety assembly



Remove the transportation safety assembly before using the dryer for the first time.

Open the loading door.

There is a nylon bag inside the drum that contains a piece of styrofoam. Hold it from its section marked with **XX XX**.

Pull the nylon towards yourself and remove the transportation safety assembly.

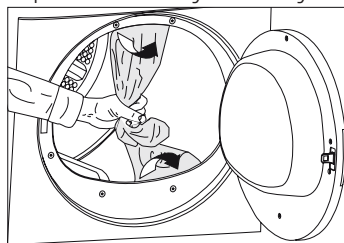

Check that no part of the transportation safety assembly remains inside the drum.

3.3 Connecting to the drain

In products equipped with condenser unit, water accumulates in the water tank during the drying cycle. You should drain accumulated water after each drying cycle.

You can directly drain accumulated water through the water drain hose supplied with the product instead of periodically draining the water collected in the water tank.

Please refer to the detailed instructions supplied with the accessories pack.

Connecting the water drain hose

- 1-2** Pull hose at the behind of the dryer by hand in order to disconnect it from where it is connected. Do not use any tools to remove the hose.
- 3** Connect one end of the drain hose supplied with the dryer to the connection point from where you removed the hose of the product in previous step.
- 4** Connect the other end of the drain hose directly to the wastewater drain or to the washbasin.

Installation

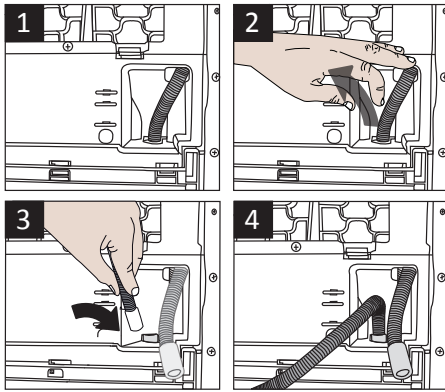

Hose connection should be made in a safe manner. Your drain house will be flooded if the hose comes out of its housing during water discharge.



Water drain hose should be attached to a height of maximum 100 cm.



Make sure that the water drain hose is not stepped on and it is not folded between the drain and the machine.

3.4 Adjusting the feet

In order to ensure that the dryer operates more silently and vibration-free, it must stand level and balanced on its feet. Balance the machine by adjusting the feet.

Turn the feet to left or right until the dryer stands level and firmly.

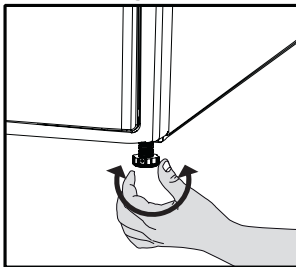

Never unscrew the adjustable feet from their housings.

3.5 Electrical connection

For specific instructions for electrical connection required during installation (See 1.1.1 Electrical Safety)

3.6 Transportation of the dryer

Unplug the dryer before transporting it. Drain all water that has remained in the dryer. If direct water drain connection is made, then remove the hose connections.



We recommend carrying the dryer in upright position. If it is not possible to carry the machine in the upright position, we recommend carrying it by tilting towards the right side when looked from the front.

3.7 Changing the illumination lamp

In case an illumination lamp is used in your laundry dryer. To change the Bulb/LED used for illumination of your tumble dryer, call your Authorized Service.

The lamp(s) used in this appliance is not suitable for household room illumination. The intended purpose of this lamp is to assist the user to place laundry in the tumble dryer in a comfortable way. The lamps used in this appliance have to withstand extreme physical conditions such as vibrations and temperatures above 50 °C.

4 Electrical Connection

Make sure that you have an earthed power outlet socket rated at 13 amps (minimum).

4.1 Attention!

When installed, the socket must be reachable after installation, or a separate switch (which can disconnect the two poles) must be used in the installation. Check for suitability.

For a permanent connection, a master switch with at least 3mm contact clearance and minimum 13 A rating must be used.

4.2 Electrical requirements

Before you insert the plug into the wall socket make sure that the voltage and the frequency shown in the rating label corresponds to your electricity supply.

We recommend that this appliance be connected to the mains supply via a suitable switched and fused socket in a readily accessible position.

Should the mains lead of the appliance become damaged or need replacing at any time, it must be replaced by a special purpose made mains lead which can only be obtained from a Authorised Service Agent.



Warning

This appliance must be earthed
If the fitted moulded plug is not suitable for your socket, then the plug should be cut off and an appropriate plug fitted.

The moulded plug on this appliance incorporates a 13A fuse. Should the fuse need to be replaced an ASTA approved BS1362 fuse of the same rating must be used. Do not forget to refit the fuse cover. In the event of losing the fuse cover, the plug must not be used until a replacement fuse cover has been fitted. Colour of the replacement fuse cover must be the same colour as that visible on the pin face of the plug. Fuse covers are available from any good electrical store.

In order to avoid hazards, damaged supply cord should be replaced by the manufacturer, its service agent or similarly qualified people. Built-under installation

This appliance can be installed under a worktop.



Do not operate without the top cover fitted. Risk of injury.



Important

4.3 Fitting a different plug

As the colours of the wires in the mains lead of this appliance may not correspond with the coloured markings identifying the terminals on your plug, proceed as follows:

1 Connect the green - yellow or green (earth) wire to the terminal in the plug marked 'E' or with the symbol or coloured green and yellow or green.

2 Connect the blue (neutral) wire to the terminal in the plug marked 'N' or coloured black.

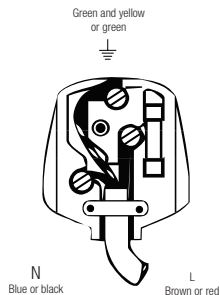

3 Connect the brown (live) wire to the terminal in the plug marked 'L' or coloured red. With the alternative plugs a 13A fuse must be fitted either in the plug or adaptor or in the main fuse box. If in doubt contact a qualified electrician.

4.4 Washer/dryer combination

Do not stack washing machine on top of the tumble dryer. This would damage both appliances and guarantees would become void. It is also unsafe to stack an appliance on top of another without using a suitable and approved stacking kit obtained from the manufacturer of the appliances.

- A special stacking kit is required as an optional extra please contact customer service.

5 Preparation

5.1 Laundry suitable for drying in the dryer

Always obey the instructions given on the garment tags. Dry only the laundry having a label stating that they are suitable for drying in a dryer and make sure that you select the appropriate programme.

| LAUNDRY DRYING SYMBOLS | | | | | | | | | | | | | | | | | | | | | |
|------------------------|---------------------|--|--------------------|--|--------------------------|--|----------------------------|--|-------------------------|--|-----------------|--|--------------------|--|------------|--|-----------------|--|----------------------|--|---------------|
| | Drying Symbols | | Suitable for dryer | | No Iron | | Sensitive / Delicate dry | | Do not dry with dryer | | Do not dry | | Do not dry-clean | | | | | | | | |
| | Drying Settings | | At any temperature | | At high temperature | | At medium temperature | | At low temperature | | Without heating | | Hang to dry | | Lay to dry | | Hang wet to dry | | Lay in shadow to dry | | Dry-cleanable |
| | Iron - | | | | Iron at high temperature | | Iron at medium temperature | | Iron at low temperature | | Do not iron | | Iron without steam | | | | | | | | |
| | Dry or Steam | | | | | | | | | | | | | | | | | | | | |
| | Maximum temperature | | 200 °C | | | | 150 °C | | 110 °C | | | | | | | | | | | | |

5.2 Laundry not suitable for drying in the dryer



Delicate embroidered fabrics, woollen, silk garments, delicate and valuable fabrics, airtight items and tulle curtains are not suitable for machine drying.

5.3 Preparing laundry for drying

- Laundry may be tangled with each other after washing. Separate the laundry items before placing them into the dryer.
- Dry garments having metal accessories such as zippers, inside out.
- Fasten the zippers, hooks and buckles and button sheets.

5.4 Things to be done for energy saving

Following information will help you use the dryer in an ecological and energy-efficient manner.

- Spin your laundry at the highest speed possible when washing them. Thus, the drying time is shortened and energy consumption is reduced. Sort out the laundry depending on their type and thickness. Dry the same type of laundry together. For example thin kitchen towels and table clothes dries earlier than thick bathroom towels.
- Follow the instructions in the user manual for programme selection.
- Do not open the loading door of the machine during drying unless necessary. If you must certainly open the loading door, do not to keep it open for a long time.
- Do not add wet laundry while the dryer is in operation

Preparation

- Clean the lint filter before or after each drying cycle
- Clean the condenser regularly at least once every month or after every 30 drying cycles.
- Ventilate the room, where the dryer is located, well during drying.

5.5 Correct load capacity

Follow the instructions in the "Programme selection and consumption table". Do not load more than the capacity values stated in the table.

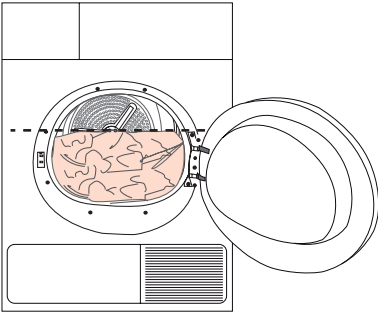

It is not recommended to load the dryer with laundry exceeding the level indicated in the figure. Drying performance will degrade when the machine is overloaded. Furthermore, dryer and the laundry can get damaged.

Following weights are given as examples.

| Laundry | Approximate weights (g)* |
|-----------------------------|--------------------------|
| Cotton quit covers (double) | 1500 |
| Cotton quit covers (single) | 1000 |
| Bed sheets (double) | 500 |
| Bed sheets (single) | 350 |
| Large tablecloths | 700 |
| Small tablecloths | 250 |
| Tea napkins | 100 |
| Bath towels | 700 |
| Hand towels | 350 |
| Blouses | 150 |
| Cotton shirts | 300 |
| Shirts | 250 |
| Cotton dresses | 500 |
| Dresses | 350 |
| Jeans | 700 |
| Handkerchiefs (10 pieces) | 100 |
| T-Shirts | 125 |

*Dry laundry weight before washing.

6 Operating the product

6.1 Control panel

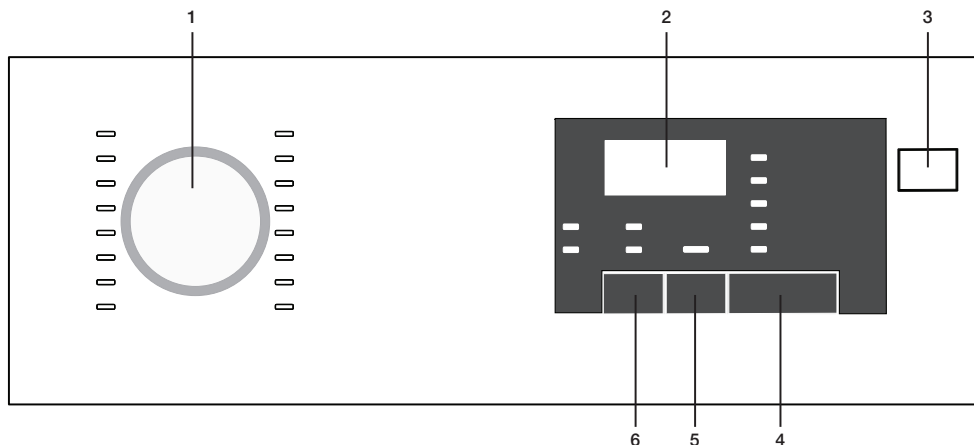

1. Programme selection knob
2. Remaining duration indicator
3. On/Off button
4. Start/pause button
5. End duration button
6. Sound warning button

6.2 Screen symbols

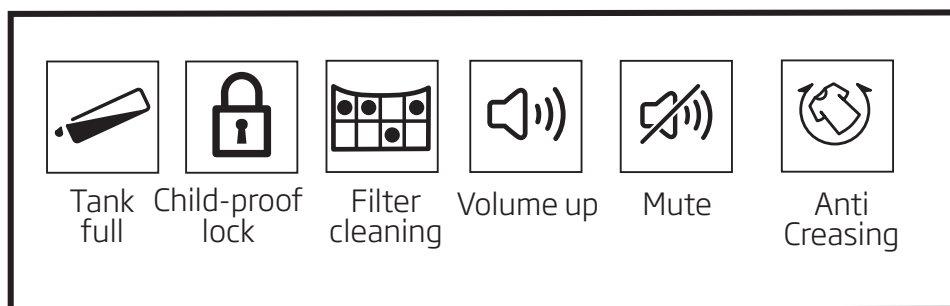

Operating the product

6.3 Preparing the machine

1. Plug in the machine
2. Place laundry inside the machine.
3. Press the On/Off button.
4. When your machine turns on for the first time, it turns on with the declaration (cotton cabinet dryness) Programme.



Pressing the On/Off button doesn't mean the Programme starts.
Press the Start / Pause button to start the Programme.

6.4 Programme selection

1. Determine the appropriate Programme from the chart below containing the drying levels.
2. Select the Programme you desire using the Programme Selection knob.

| | |
|-------------------|--|
| Extra Dry | Only cotton laundry is dried in normal temperature. Thick and multi-layered laundry (towels, sheets, jeans etc.) are dried so that they can be placed into wardrobe without ironing. |
| Cupboard dry | Normal laundry (tablecloths, underwear etc.) are dried so that they can be placed into wardrobe without ironing. |
| Cupboard dry Plus | Normal laundry (Ex: tablecloths, underwear) are again dried so that they can be placed into the wardrobe but more so than the wardrobe dryness option. |
| Iron Dry | Normal laundry (shirts, dresses etc) are dried ready for ironing. |



For detailed Programme information see „Programme selection and consumption table“..

6.5 Main Programmes

The main Programmes are given below based on fabric type.

- **Cotton**

Dry durable laundry with this Programme. It dries in normal temperature. Recommended for use with your cotton laundry (sheets, bed covers, towels, bathrobes etc.)

- **Synthetic**

Dry laundry that is not very durable with this Programme. Recommended for use with your synthetic laundry.

6.6 Extra Programmes

The following extra Programmes are available in the machine for special conditions.



Extra Programmes may vary according to the specifications of your machine.



In order to receive better results from drying machine Programmes, your laundry should be washed with the appropriate Programme in your washing machine and wringed with recommended wringing revolution..

- **Jeans**

Use to dry jeans that are wringed with high rpm in washing machine.

- **Sport**

Used to dry the laundry that are made of synthetic, cotton or mixed fabrics and have a tag indicating that they are suitable for drying.

- **Shirts 15 min.**

Dries shirts more delicately and thus causes less wrinkles for easy ironing.

- **Baby Protect**

Programme used for baby clothing with can be dried approval on the label.



Very little dampness might remain on the shirts after the Programme. It is recommended that you do not leave the shirts in the drying machine.

Operating the product

- **Delicates**

You can dry your delicates suitable for drying or laundry that is recommended to hand wash (silk blouses, thin underwear etc.) in low temperature.



It is recommended to dry your delicates in laundry bag to prevent wrinkles and damage. When the Programme ends, take your laundry out of the machine immediately and hang them to prevent wrinkles.

- **Freshen Up**

It only performs ventilation for 10 minutes without blowing hot air. You can ventilate the cotton and linen clothing that has remained closed for a long duration and remove their odor.

- **Timed Programmes**





You can select the 10 mins, 20 mins, 40 mins and 60 mins time Programmes to achieve the desired final drying level with low temperature.



On this Programme, the machine dries as long as the set duration, regardless of the drying level.

Operating the product

6.7 Programme selection and consumption table

| EN | | | | | |
|---|---------------|-------------------------------------|--|------------------------------|--|
| Programs | Capacity (kg) | Spin speed in washing machine (rpm) | Approximate amount of remaining humidity | Drying time (minutes) | |
| Cottons / Coloreds | | | | | |
|  Extra dry | 9 | 1000 | % 60 | 159 | |
|  Cupboard dry | 9 / 4,5 | 1000 | % 60 | 149 / 84 | |
|  Iron dry | 9 | 1000 | % 60 | 112 | |
| Shirts 15 min. | 0,5 | 1200 | % 60 | 15 | |
| Jeans | 4 | 1200 | %50 | 80 | |
| Sport | 4 | 1000 | %60 | 92 | |
| Delicates | 2 | 600 | %40 | 40 | |
| BabyProtect | 3 | 1000 | % 60 | 70 | |
| Synthetics | | | | | |
|  Cupboard dry | 4,5 | 800 | % 40 | 58 | |
|  Iron dry | 4,5 | 800 | % 40 | 50 | |
| Energy consumption values | | | | | |
| Programs | Capacity (kg) | Spin speed in washing machine (rpm) | Approximate amount of remaining humidity | Energy consumption value kWh | |
| Cottons linen Ready to wear* | 9 / 4,5 | 1000 | % 60 | 5,12 / 2,85 | |
| Cottons Ready to iron | 9 | 1000 | % 60 | 4,1 | |
| Synthetics Ready to wear | 4,5 | 800 | % 40 | 1,9 | |
| Power consumption of the off-mode for the standart cotton programme at full load, PO (W) | | | | 0,5 | |
| Power consumption of the left-on mode for the standart cotton programme at full load, PL (W) | | | | 1,0 | |

 „Cotton cupboard dry Programme“ used at full and partial load is the standard drying Programme to which the information in the label and the fiche relates, that this Programme is suitable for drying normal wet cotton laundry and that it is the most efficient Programme in terms of energy consumption for cotton.

 When selecting the Cottons programme, send the condensed water out through the drain hose.

* : Energy Label standard Programme (EN 61121:2012) “All the filters must be cleaned prior to test series.” All the values in the table are determined according to EN 61121:2012 standard. Consumption values may vary from the values in the table depending on laundry type, wringing revolution, ambient conditions and changes in voltage.

Operating the product

6.8 Auxiliary functions

Sound warning cancel

Drying machine makes sound warnings when the Programme is completed. If you don't want sound notifications, press the "Sound Notification" button.

When you press the sound notification button it lights up, and Programme does not make sound notifications when completed.



You can select this function before or after the Programme starts.

Anti-creasing

A 2-hour anti creasing program to prevent laundry from creasing will be activated if you do not take the laundry out after the program has come to an end. This programme rotates the laundry in 10-minute intervals to prevent creasing.

6.9 Warning symbols



Warning symbols may vary according to the specifications of your machine.

Fiber filter cleaning

When the Programme is completed, a warning led lights up, which indicates that the filter has to be cleaned.

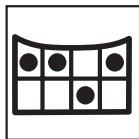

If the filter cleaning led blinks, see the „Troubleshooting“ chapter.

Water tank

When the Programme is completed, a warning led lights up, which indicates that the water tank must be emptied.

If the water tank fills up while the Programme is running, warning led starts blinking and the machine goes into stand-by. In that case empty the water in the water tank and start the Programme by pressing

the Start / Pause button. Warning led turns off and the Programme resumes.



Loading door open

Start/Pause led blinks when the loading door of the drying machine is open.

6.10 End duration

You can delay the end duration of the Programme for up to 24 hours with the end duration function.

1. Open the loading door and place your laundry.
2. Select the drying Programme.
3. Press the end duration selection button and set the delay duration you want. End duration led lights up. (End duration moves continuously when you keep pressing the button).
4. Press the Start / Pause button. End duration countdown begins. The „:“ sign in the middle of the displayed delay duration blinks.



You can add or remove laundry for the duration of the end duration. The duration displayed on the screen is the sum of the normal drying duration and the end duration. At the end of the countdown the end duration led turns off, drying beings and drying led lights up.

Changing the end duration

If you want to change the duration during the countdown:

1. Cancel the Programme by pressing the On/Off button. Turn on the drying machine again by pressing the On/Off button. When your drying machine turns on for the first time, it turns on with the declaration (cotton wardrobe dryness) Programme.
2. Select the Programme you desire using the Programme Selection knob.

Operating the product

3. Repeat the end duration operation for the duration you want.
4. Start the Programme by pressing the Start / Pause button.

Canceling the end duration function

If you want to cancel the end duration setting countdown and start the Programme right away:

1. Cancel the Programme by pressing the On/Off button. Turn on the drying machine again by pressing the On/Off button. When your drying machine turns on for the first time, it turns on with the declaration (cotton wardrobe dryness) Programme.
2. Select the Programme you desire using the Programme Selection knob.
3. Start the Programme by pressing the Start / Pause button.

6.11 Starting the Programme

Start the Programme by pressing the Start / Pause button.

Start/Pause led and the Drying led light up, indicating the Programme started. The “i” sign in the middle of the remaining duration starts to blink.

6.12 Child Lock

The machine features a child lock which prevents the machine Programme flow from being affected when buttons are pressed during operation.

When the Child Lock is active, all buttons except for the On/Off button are deactivated. To activate the child lock, press the Sound Notification button and End Duration button simultaneously for 3 seconds.

The child lock should be deactivated to be able to start a new Programme after the current Programme ends or to be able to interfere with the current Programme. Keep the same buttons pressed for 3 seconds again to deactivate the child lock.



The lock led on the screen lights up when the Child Lock is activated.



Child Lock deactivates when the machine is turned off and on again using the On/Off button.

A warning sound is heard when any button is pressed (except for On/Off button) or the Programme Selection knob is turned while the child lock is active.

6.13 Changing the Programme after it is started

After the machine starts running, you can change the Programme you selected to dry your laundry with a different Programme.

1. For example, to select Extra Dry Programme instead of the Iron Dryness, stop the Programme by pressing the Start / Pause button.
2. Turn the Programme Selection knob to select the Extra Dry Programme.
3. Start the Programme by pressing the Start / Pause button.

Adding and removing laundry in stand-by mode

If you want to add or remove laundry after the drying Programme starts:

1. Press the Start/Pause button to take the machine into Stand-by mode. Drying operation stops.
2. Open the loading door, add or remove laundry and close the loading door.
3. Start the Programme by pressing the Start / Pause button.



The laundry adding made after the drying operation started may cause the dried laundry inside the machine to mix with the wet laundry and the laundry to remain damp after the operation ends..



Laundry adding and removing can be repeated as much as desired during drying operation. But this process would continuously interrupt the drying operation, and so would cause the Programme duration to lengthen and increase energy consumption. Thus, it is recommended to add laundry before the Programme starts.

Operating the product



If a new Programme is selected by changing the position of the Programme selection knob while your machine is in stand-by mode, the running Programme ends.



Do not contact the inner surface of the drum when adding or removing laundry during a continuing Programme. The drum surface is hot.

6.14 Cancelling the Programme

If you want to cancel the Programme and end the drying operation for any reason after the machine starts running, press the On/Off button.



As it will be extremely hot inside the machine when you cancel the Programme while the machine is in operation; run the ventilation Programme to cool it down.

6.15 Programme end

When the Programme ends, the Final/Wrinkle Prevention, Fiber Filter Cleaning and Water Tank Warning leds on the Programme follow up indicator light up. Loading door can be opened and machine becomes ready for a second run.

Press the On/Off button to turn off the machine.



In case the laundry is not removed after the Programme is completed, the wrinkle prevention Programme that lasts 2 hours start in order to prevent wrinkling of the laundry that remains inside the machine.



Clean the fibre filter after each drying. (See. „Fibre filter and loading door inner surface“)



Empty the water tank after each drying. (See. „Emptying the water tank“)

7 Maintenance and cleaning

Service life of product extends and frequently experienced problems will be reduced if it is cleaned at regular intervals.

7.1 Cleaning Lint Filter / Loading Door Inner Surface

Lint and fibre released from the laundry to the air during the drying cycle are collected in the Lint Filter.



Such fibre and lint are generally formed during wearing and washing.



Always clean the lint filter and the inner surfaces of the loading door after each drying process.



You can clean the lint filter housing with a vacuum cleaner.

To clean the lint filter:

- Open the loading door.
- Remove the lint filter by pulling it up and open the lint filter.
- Clean lint, fibre, and cotton raveling by hand or with a soft piece of cloth.
- Close the lint filter and place it back into its housing.

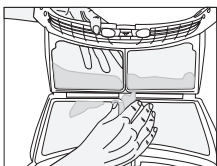
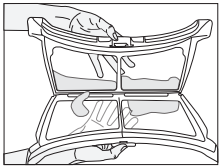
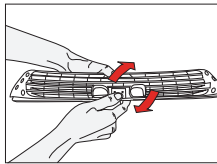
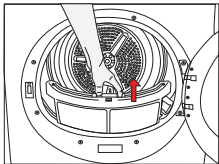

- A layer can build up on the filter pores that can cause clogging of the filter after using the dryer for a while. Wash the lint filter with warm water to remove the layer that builds up on the lint filter surface. Dry the lint filter completely before reinstalling it.

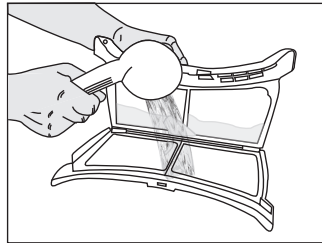

- Clean the entire inner surface of the loading door and loading door gasket with a soft damp cloth.

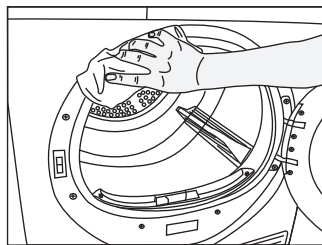
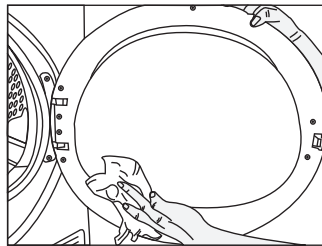

Maintenance and cleaning

7.2 Cleaning the sensor

There are dampness sensors in the dryer that detect whether the laundry is dry or not. To clean the sensors:

- Open the loading door of the dryer.
- Allow the machine to cool down if it is still hot due to the drying process.
- Wipe the metal surfaces of the sensor with a soft cloth, dampened with vinegar and dry them.



Clean metal surfaces of the sensors 4 times a year.



Do not use metal tools when cleaning metal surfaces of the sensors.



Never use solvents, cleaning agents or similar substances for cleaning due to the risk of fire and explosion!

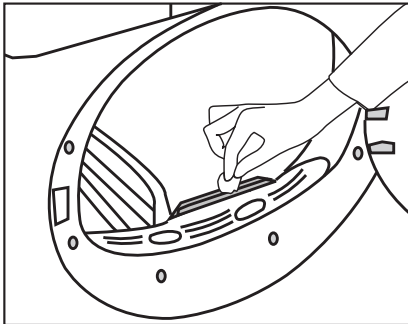

7.3 Draining the water tank

Dampness of the laundry is removed and condensed during drying process and the water that arise accumulates in the water tank. Drain the water tank after each drying cycle.



Condensed water is not drinkable!



Never remove the water tank when the programme is running!

If you forget to drain the water tank, the machine will stop during the subsequent drying cycles when the water tank is full and the Water Tank warning symbol will flash. If this is the case, drain the water tank and press **Start / Pause** button to resume the drying cycle.

To drain the water tank:

Pull the drawer and remove the water tank carefully.

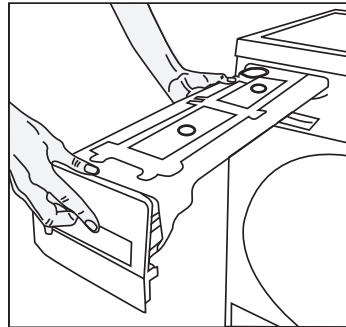

- Drain the water in the tank.

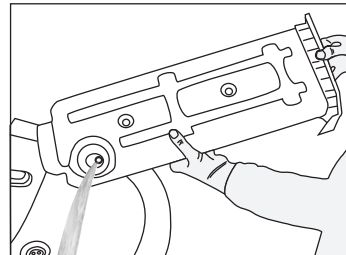

- If there is lint accumulation in the funnel of the water tank, clean it under running water.
- Place the water tank into its seat.

Maintenance and cleaning



If the direct water draining is used as an option, there is no need to empty the water tank.

7.4 Cleaning the condenser;

Hot and humid air in the condenser is cooled with the cold air from the room. Thus, the humid air circulating in your dryer is condensed and then pumped into the tank.



Clean the condenser after every 30 drying cycles or once a month.

To clean the condenser:

1. If a drying process has been carried out, open the door of the machine and wait until it cools down.

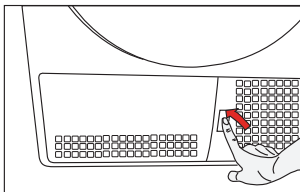

2. Unlock the 2 condenser locks after opening the kick plate.

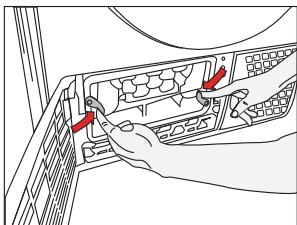

3. Pull out the condenser.

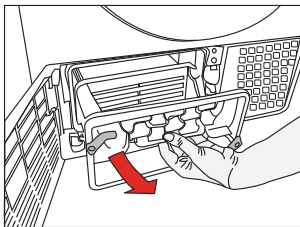

4. Clean the condenser by applying pressurized water with a shower head and wait until the water drains and the condenser is dry.

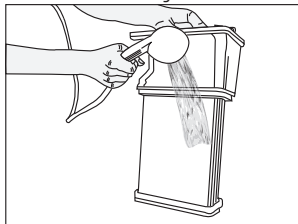

5. Place the condenser in its housing. Fasten the 2 locks and make sure that they are seated securely.

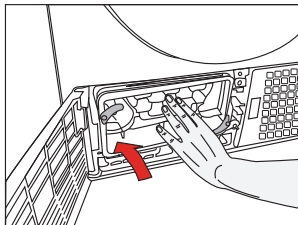

6. Close the kick plate cover.

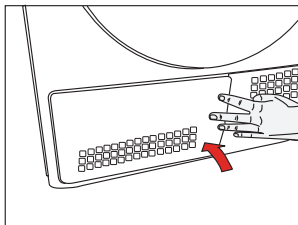

8 Troubleshooting

Drying process lasts for a long time.

- Pores of the fibre filter might be clogged. >>> **Wash the filter with warm water.**
- Condenser might be clogged. >>> **Wash the condenser.**
- Ventilation grills at the front of machine might be blocked. >>> **Remove any items in front of the ventilation grills that block ventilation.**
- Ventilation might be inadequate if the installation area is very small. >>> **Open the windows and doors in order to prevent excessive increase in room temperature.**
- There might be furring on the damp sensor. >>> **Clean the damp sensor.**
- Laundry might be overloaded. >>> **Do not overload the tumble drier.**
- Laundry might not have been adequately spun. >>> **Increase the rpm of tumble drier.**

Laundry is still wet at the end of drying.



Hot laundry unloaded at the end of drying feel wetter than they really are.

- You may not have used a programme suitable for laundry type. >>> **Check the maintenance labels on the laundry and select a programme suitable for their type, or use the time programmes additionally.**
- Pores of the fibre filter might be clogged. >>> **Wash the filter with warm water.**
- Condenser might be clogged. >>> **Wash the condenser.**
- Laundry might be overloaded. >>> **Do not overload the tumble drier.**
- Laundry might not have been adequately spun. >>> **Increase the rpm of tumble drier.**

Tumble drier does not turn on or programme cannot be started. Tumble drier does not activate when set.

- The power cord might not be plugged in. >>> **Make sure the power cord is plugged in.**
- Loading door might be open. >>> **Make sure that the loading door is properly closed.**
- You may not have set the programme or pressed the Start/Pause button. >>> **Make sure that you have set the programme and it is not in Pause position.**
- Child lock might be active. >>> **Disable the child lock.**

Programme was interrupted for no reason.

- Loading door might not be properly closed. >>> **Make sure that the loading door is properly closed.**
- A power cut might have occurred. >>> **Press the Start/ Pause button to start the programme.**
- Water tank might be full. >>> **Drain the water tank.**

Laundry is shrunk, damaged or worn out.

- You may not have used a programme suitable for laundry type. >>> **Check the maintenance labels on the laundry and select a programme suitable for their type.**

The lighting inside the tumble drier does not turn on. (In models with lamps)

- You may not have turned on the tumble drier by using On/Off/Cancel button. >>> **Make sure that the tumble drier is at 'on' position.**
- Lamp might be broken. >>> **Contact the Authorised Service for the replacement of lamp.**

Filter cleaning warning led is on.

- Fibre filter might not have been cleaned. >>> **Clean the filter.**

Troubleshooting

Filter cleaning warning led flashes.

- Filter bearing might be clogged with fibre. >>> **Clean the filter bearing.**
- There might be a layer in the filter pores that causes clogging. >>> **Wash the filter with warm water.**
- Condenser might be clogged. >>> **Wash the condenser.**

Water is leaking from the condenser cover.

- There might be fibre build-up inside the loading door and on the surfaces of loading door gasket. >>> **Clean the inner surfaces of loading door and surfaces of loading door gasket.**

Loading door opens itself.

- Loading door might not be properly closed. >>> **Push the loading door until you hear the closing sound.**

Water tank warning led is on/flashes.

- Water tank might be full. >>> **Drain the water tank.**
- Water drain hose might be folded. >>> **Check the water drain hose if the product is directly connected to the water outlet.**



If you cannot eliminate the problem despite following these instructions, please contact the vendor that sold you the product or an Authorised Service. Do not try to repair the product yourself

9 Service

Please keep your purchase receipt or other proof of purchase in a safe place; you will need to have it should the product require attention under guarantee.

You should also complete the details below; it will help us assist you when requesting service. (The model number is printed on the Instruction Booklet and the serial number is printed on the Rating Label affixed to the appliance)

Model No:

Serial No:

Retailer:

Date of purchase:

9.1 Republic of Ireland

All Refrigeration, 01 862 3411

All Cookers

Washing Machines & Dryers, Tumble Dryers

Dishwashers

Before requesting service please check the trouble-shooting guide in the Operating Instructions as a charge may be levied where no fault is found even though your product may still be under guarantee.

9.2 Service once the manufacturers guarantee has expired.

If you have purchased an extended guarantee please refer to the instructions contained within the extended guarantee agreement document. Otherwise please call the appropriate number above where service can be obtained at a charge.

Should you experience any difficulty in obtaining service please contact the Customer Help-Line.

Tel: 0845 600 4911

For service under guarantee simply telephone the appropriate number below.

9.3 UK Mainland & Northern Ireland

Fridges & Freezers 0345 600 4903 or 0845 600 4903

Electric Cookers 0345 600 4902 or 0845 600 4902

Gas & Dual Fuel Cookers

0345 600 4905 or 0845 600 4905

Washing Machines & Tumble Dryers
0345 600 4906 or 0845 600 4906

PRODUCT FICHE

Complying Commission Delegated Regulation (EU) No 392/2012

| | | |
|---|---------------|----------------------|
| Supplier name or trademark | | Beko |
| Model name | | DCR93161W / DCY9316G |
| Rated capacity (kg) | | 9 |
| Type of Tumble Dryer | Air Vented | - |
| | Condenser | • |
| Energy efficiency class ⁽¹⁾ | | B |
| Annual Energy Consumption (kWh) ⁽²⁾ | | 616 |
| Type of Control | Automatic | • |
| | Non-automatic | - |
| Energy consumption of the standard cotton programme at full load (kWh) | | 5,12 |
| Energy consumption of the standard cotton programme at partial load (kWh) | | 2,85 |
| Power consumption of the off-mode for the standart cotton programme at full load, P ₀ (W) | | 0,5 |
| Power consumption of the left-on mode for the standart cotton programme at full load, P _L (W) | | 1,0 |
| The duration of the left on mode (min) | | 30 |
| Standard cotton programme ⁽³⁾ | | |
| Programme time of the standard cotton programme at full load, T _{dry} (min) | | 149 |
| Programme time of the standard cotton programme at partial load, T _{dry1/2} (min) | | 84 |
| Weighted programme time of the standard cotton programme at full and partial load (T _w) | | 112 |
| Condensation efficiency class ⁽⁴⁾ | | B |
| Average condensation efficiency of the standard cotton programme at full load, C _{dry} | | 85% |
| Average condensation efficiency of the standard cotton programme at partial load, C _{dry1/2} | | 85% |
| Weighted condensation efficiency of the standard cotton programme at full load and partial load, C _t | | 85% |
| Sound power level for the standard cotton programme at full load ⁽⁵⁾ | | 66 |
| Built-in | | - |

• : Yes - : No

(1) Scale from A+++ (most efficient) to D (least efficient)

(2) Energy consumption based on 160 drying cycles of the standard cotton programme at full and partial load, and the consumption of the low-power modes. Actual energy consumption per cycle will depend on how the appliance is used.

(3) "Cotton cupboard dry programme" used at full and partial load is the standard drying programme to which the information in the label and the fiche relates, that this programme is suitable for drying normal wet cotton laundry and that it is the most efficient programme in terms of energy consumption for cotton

(4) Scale from G (least efficient) to A (most efficient)

(5) Weighted average value — L_{WA} expressed in dB(A) re 1 pW

Guarantee

Your new product is guaranteed against the cost of breakdown repairs for twelve months from the date of the original purchase.

What is covered?

- Repairs necessary as a result of faulty materials, defective components or manufacturing defect.
- The cost of functional replacement parts, but excluding consumable items.
- The labour costs of a approved repairer to carry out the repair.

What is not covered?

- Transit, delivery or accidental damage or misuse and abuse.
- Cabinet or appearance parts, including knobs, flaps, handles or container lids.
- Accessories or consumable items including but not limited to, ice trays, scrapers, cutlery baskets, filters and light bulbs.
- Repairs required as a result of unauthorised repair or inexperienced installation that fails to meet the requirements contained in the user instruction book.
- Repairs to products used on commercial or non-residential household premises.
- Loss of frozen food in freezers or fridge/freezers. (Food loss insurance is often included within your household contents insurance policy, or may be available separately from your retailer).

Important notes

- Your product is designed and built for domestic household use only.
- The guarantee will be void if the product is installed or used in commercial or non-residential domestic household premises.
- The product must be correctly installed, located and operated in accordance with the instructions contained in the User Instructions Booklet provided.
- Professional installation by a qualified Electrical Domestic Appliance Installer is recommended for all Washing Machines, Tumble Dryers, Dishwashers, Dryers and Electric Cookers
- Gas Cookers must only be installed by a Gas safe registered Gas Installer.
- The guarantee is given only within the boundaries of the United Kingdom and the Republic of Ireland.
- The guarantee is applicable only to new products and is not transferable if the product is resold.
- Disclaims any liability for incidental or consequential damages.
- The guarantee does not in anyway diminish your statutory or legal rights.

Beko plc, Beko House, 1 Greenhill Crescent, Watford, WD18 8QU

Tel: 0845 6004911

Email: service@beko.co.uk

Fax: 0845 6004922

www.beko.co.uk